

GUIDELINES

Venous Hemodynamic Changes in Lower Limb Venous Disease: the UIP Consensus According to Scientific Evidence

Byung-Boong LEE, Andrew N. NICOLAIDES, Kenneth MYERS, Mark MEISSNER, Evi KALODIKI, Claudio ALLEGRA, Pier Luigi ANTIGNANI, Niels BÆKGAARD, Kirk BEACH, Giovanni BELCARO, Stephen BLACK, Lena BLOMGREN, Elete BOUSKELA, Massimo CAPPELLI, Joseph CAPRINI, Patrick CARPENTIER, Attilio CAVEZZI, Sylvain CHASTANET, Jan T. CHRISTENSON, Demetris CHRISTOPOULOS, Heather CLARKE, Alun DAVIES, Marianne DE MAESENEER, Bo EKLOF, Stefano ERMINI, Fidel FERNÁNDEZ, Claude FRANCESCHI, Antonios GASPARI, George GEROUKAKOS, Sergio GIANESINI, Athanosis GIANNOUKAS, Peter GLOVICZKI, Ying HUANG, Veronica IBEGBUNA, Stavros KAKKOS, Robert KISTNER, Tilo KÖLBEL, Ralph L.M. KURSTJENS, Nicos LABROPOULOS, JAMES LAREDO, CHRISTOPHER R. LATTIMER, Marzia LUGLI, Fedor LURIE, Oscar MALETI, Jovan MARKOVIC, Erika MENDOZA, Javier L. MONEDERO, Gregory MONETA, Hayley MOORE, Nick MORRISON, Giovanni MOSTI, Olle NELZÉN, Alfred OBERMAYER, Tomohiro OGAWA, Kurosh PARSİ, Hugo PARTSCH, Fausto PASSARIELLO, Michel R. PERRIN, Paul PITTALUGA, Seshadri RAJU, Stefano RICCI, Antonio ROSALES, Angelo SCUDERI, CARL-ERIK SLAGSVOLD, ANDERS THURIN, Tomasz URBANEK, Andre VAN RIJ, Michael VASQUEZ, Cees H. A. WITTENS, Paolo ZAMBONI, Steven ZIMMET, Santiago Zubicoa EZPELETA
(For affiliations and contributions of authors see Appendix)

Document developed under the auspices of Union Internationale de Phlebologie, European Venous Forum, Cardiovascular Disease Educational and Research Trust

Corresponding author: Byung-Boong Lee, Division of Vascular Surgery, Department of Surgery, George Washington University Medical Center, 22nd and I Street, NW, 6th Floor, Washington, DC 20037, USA. E-mail: bblee38@comcast.net

ABSTRACT

There are excellent guidelines for clinicians to manage venous diseases but few reviews to assess their hemodynamic background. Hemodynamic concepts that evolved in the past have largely remained unchallenged in recent decades, perhaps due to their often complicated nature and in part due to emergence of new diagnostic techniques. Duplex ultrasound scanning and other imaging techniques which evolved in the latter part of the 20th century have dominated investigation. They have greatly improved our understanding of the anatomical patterns of venous reflux and obstruction. However, they do not provide the physiological basis for understanding the hemodynamics of flow, pressure, compliance and resistance. Hemodynamic investigations appear to provide a better correlation with post-treatment clinical outcome and quality of life than ultrasound findings. There is a far better prospect for understanding the complete picture of the patient's disability and response to management by combining ultrasound with hemodynamic studies. Accordingly, at the instigation of Dr Angelo Scuderi, the Union Internationale de Phlebologie (UIP) executive board commissioned a large number of experts to assess all aspects of management for venous disease by evidence-based principles. These included experts from various member societies including the European Venous Forum (EVF), American Venous Forum (AVF), American College of Phlebology (ACP) and Cardiovascular Disease Educational and Research Trust (CDERT). Their aim was to confirm or dispel long-held hemodynamic principles and to provide a comprehensive review of venous hemodynamic concepts underlying the pathophysiology of lower limb venous disorders, their usefulness for investigating patients and the relevant hemodynamic changes associated with various forms of treatment. Chapter 1 is devoted to basic hemodynamic concepts and normal venous physiology. Chapter 2 presents the mechanism and magnitude of hemodynamic changes in acute deep vein thrombosis indicating their pathophysiological and clinical significance. Chapter 3 describes the hemodynamic changes that occur in different classes of chronic venous disease and their relation to the anatomic extent of disease in the macrocirculation and microcirculation. The next four chapters (Chapters 4-7) describe the hemodynamic changes resulting from treatment

by compression using different materials, intermittent compression devices, pharmacological agents and finally surgical or endovenous ablation. Chapter 8 discusses the unique hemodynamic features associated with alternative treatment techniques used by the CHIVA and ASVAL. Chapter 9 describes the hemodynamic effects following treatment to relieve pelvic reflux and obstruction. Finally, Chapter 10 demonstrates that contrary to general belief there is a moderate to good correlation between certain hemodynamic measurements and clinical severity of chronic venous disease. The authors believe that this document will be a timely asset to both clinicians and researchers alike. It is directed towards surgeons and physicians who are anxious to incorporate the conclusions of research into their daily practice. It is also directed to postgraduate trainees, vascular technologists and bioengineers, particularly to help them understand the hemodynamic background to pathophysiology, investigations and treatment of patients with venous disorders. Hopefully it will be a platform for those who would like to embark on new research in the field of venous disease.

(Cite this article as: Lee BB, Nicolaides AN, Myers K, Meissner M, Madiki E, Allegra C *et al.* Venous Hemodynamic Changes in Lower Limb Venous Disease: the UIP Consensus According to Scientific Evidence. ; :)

Key words: Venous hemodynamics - Venous disease - Venous hemodynamic changes after treatment - Association between venous clinical severity and hemodynamic abnormalities - Venous macrocirculation - Venous microcirculation.

CONTENTS

- Foreword
- Abstract
- Chapter 1. Basic Concepts for Venous Hemodynamics and Physiology of Venous Flow
- Chapter 2. Hemodynamic Changes in Acute DVT
- Chapter 3. Hemodynamic Changes in Chronic Venous Disease
- Chapter 4. Effects of Different Types of Compression on Venous Hemodynamics and the Microcirculation
- Chapter 5. Effects of Intermittent Pneumatic Compression and Electrical Calf Muscle Stimulation Devices on Venous Hemodynamics and the Microcirculation
- Chapter 6. Effects of Pharmacotherapy on Venous Tone, Flow and the Microcirculation
- Chapter 7. Hemodynamic Effects of Abolition of Reflux in Superficial, Perforating or Deep Veins
- Chapter 8. Hemodynamic Changes after CHIVA, ASVAL and Hook Phlebectomy
- Chapter 9. Hemodynamic Effects of Relieving Pelvic Venous Reflux and Obstruction
- Chapter 10. Venous Clinical Severity and Associated Hemodynamic Changes
- Appendix: List of Authors, Contribution and Affiliations

Foreword

The UIP consensus document on venous hemodynamics represents the great effort of Prof. BB Lee and his collaborators over the past four years.

At the time I took over the UIP presidency, I was challenged by a group of colleagues to establish official

documents on new aspects of modern Phlebology particularly in some rapidly developing areas with sparse publications that were polemic, short on evidence or controversial. The idea to produce a consensus document on “Venous Hemodynamics” came with the promise to fill out a major gap in our knowledge.

With the advent of new imaging technologies, especially ultrasound, our understanding of anatomical distribution of reflux and obstruction improved and ultrasound provided a new dimension in the hands on the experienced Phlebologist. However, our understanding of venous pathophysiology based on venous hemodynamic changes has suffered.

I knew that the task to coordinate such an important project should be given to someone special who is experienced in the publication of scientific articles and well known in all continents, with abundant scientific knowledge, great work capacity and methodic approach. So I thought about an Asian who had settled in the US working as a university Professor, who had already published a few UIP Consensus documents and was very well connected with the main European experts on hemodynamics. Prof. BB Lee accepted the challenge and confronted the huge task ahead requesting collaboration with three distinguished Professors: Prof. Andrew Nicolaides, Prof. Mark Meissner and Prof. Ken Myers.

This document is now concluded and published. As it will be confirmed in the following pages, there are various and important topics that did not reach unanimous opinions. Likewise, several topics do not show enough evidence in quantity nor quality to achieve universal approval. Certainly, the principles and conclusions of this work shall be reviewed and added to in the future.

I want to thank all the distinguished colleagues who collaborated with this grandiose work. I express my

gratitude to the editors Prof. Mark Meissner, Prof. Ken Myers and Prof. Andrew Nicolaides for their time and effort. And to Prof. BB Lee a special thanks for his dedication and accomplishment of the task.

I would like to point out that the documents produced under the auspices of UIP during my presidency did not receive commercial support of any kind and is therefore free from any conflict of interest. Thank you all and enjoy your reading!

Dr. Angelo Scuderi
President of UIP (2011-2015)

Chapter 1 Basic Concepts for Venous Hemodynamics and Physiology of Venous Flow

Introduction

Lower limb veins act as passive conduits for blood flow and as a reservoir with variable capacity, both under neuromuscular control. They are tubes with valves that are part of a peripheral pump for blood flow activated by muscle contractions. Veins are collapsible and flow is affected by gravity and muscular contractions so that venous flow patterns are more complex than those in arteries. Venous flow is intermittent, varying from high velocity to no flow.

The aim of this chapter is to present several basic hemodynamic concepts that explain venous physiology in normal lower limbs.

Hydrostatic Pressure (Gravitational Pressure)

The **hydrostatic pressure** at any point results from the weight of the column of blood from the level of the heart above the point, and varies according to the body's position. The difference in hydrostatic pressure between any two points in a *continuous column* of fluid is given by

$$\Delta P = - \rho g \Delta h \quad (\text{Eq 1.1})$$

where ΔP is the pressure difference in Pa (N/m^2), ρ is the blood density in kg/m^3 , g is the acceleration due to gravity (9.8 m/s^2) and Δh is the difference in height in m. Conversion to mmHg is made using the relationship

$$1 \text{ mmHg} = \rho g h = 13600 \times 9.8 \times 0.001 = 133 \text{ Pa} = 1.327 \text{ cm blood} \quad (\text{Eq 1.2}).$$

Fluid Energy

It is emphasized that the force that drives flow between two points is not the difference in pressure but the total fluid energy. This is why in a static column of fluid, there is no flow from the bottom of the column where the hydrostatic pressure is high to the top where the hydrostatic pressure is low.

Given a constant density and no friction, steady flow between points 1 (upstream) and 2 (downstream) that lie on the stream line provides the energy per unit volume (E/V) given by the Bernoulli equation

$$E/V = p + \rho g h + (1/2)\rho v^2 \quad (\text{Eq 1.3}).$$

Thus, E/V is the sum of the three terms: p which is the **Static Pressure** that increases as flow velocity slows and relates to part of the dynamic energy being stored and converted into Potential Energy according to the Law of Conservation of Energy, $\rho g h$ is the hydrostatic pressure as described above and $(1/2)\rho v^2$ is the **Dynamic Pressure** that arises from fluid motion which relates to the Kinetic Energy. The equation is very useful owing to its simplicity and its great insight into the balance between pressure, velocity and elevation.

The hydrostatic pressure which is zero at atmospheric pressure is not influenced by the flow velocity v although it is the most variable component of pressure in the venous system. It varies with the height of the blood column, particularly in the lower limbs where the pressure at the ankle changes from a negative value with the legs elevated to around 10 mmHg lying horizontally and around 90 mmHg in the stationary upright position, enough pressure to "lift" a column of blood 120 cm from the ankle to the right atrium (90×1.327 from Eq 1.2). Muscular activity such as moving, walking or running reduces it from 90 mmHg down to 30 mmHg in the upright position in a normal circulation due to competent venous valves that fractionate the pressure column during muscular contraction (systole) and relaxation (diastole). With venous disease, venous insufficiency predominantly occurs below the knee as excessive hydrostatic pressure cannot be reduced in the upright position because of valvular incompetence or outflow obstruction. The normal function of the valves is called **Dynamic Fractioning of the hydrostatic pressure**.

The pressure exerted by the fluid against the wall of the conduits is called **Lateral Pressure** or **Parietal Pressure**.

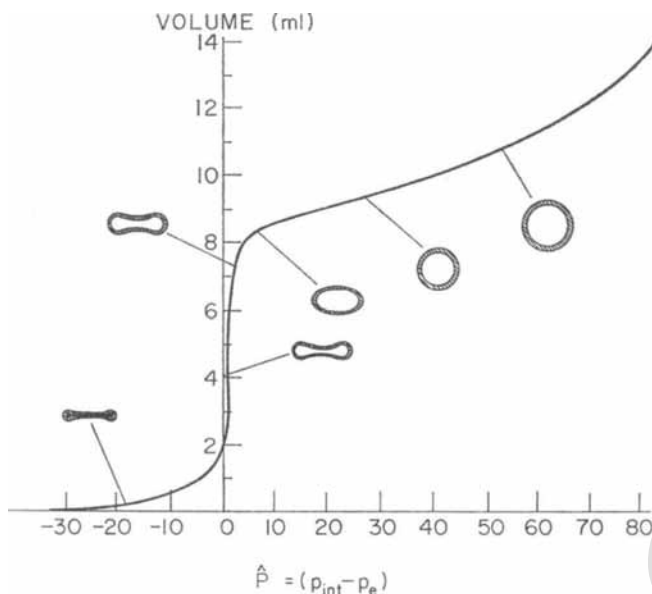

Figure 1.1.—The static pressure volume relationship (Katz, 1969).

Recalling the Bernoulli Equation, pressure p can be defined also as the **variation of energy per unit volume**

$$p = \Delta E / \Delta V \quad (\text{Eq 1.4})$$

so that $p\Delta V$ is work related to expansion under the effect of p and stored in the dilated walls. If ΔV is negative, then work is a volume contraction under the effect of previously stored energy in the wall at pressure p .

Measurement of Venous Pressure

Venous pressure can be measured invasively by inserting a catheter in a vein and connecting it by an infusion set to a fluid manometer (measurement in $\text{cm H}_2\text{O}$) or to an electro-manometer (measurement in mmHg), ($1 \text{ mmHg} = 1.36 \text{ cm H}_2\text{O}$). A zero pressure at atmospheric pressure must be defined. The measured variable is the **difference of pressure Δp** between the point examined in the vein and the zero level.

Hydraulic Pressure

This is the pressure provided by contractions of the left ventricle via the arteries through the capillaries supplying “vis-a-tergo” (i.e. pushing force acting from be-

hind) which drives the venous return. In any vein, the hydraulic pressure is the difference between the actual venous pressure and the hydrostatic pressure. Flow times resistance equals vis-a-tergo.

Because veins have many communications and a low resistance to flow, the actual venous pressure is identical in all veins in the same horizontal plane of a limb when at rest.¹ For example, the decrease in hydraulic pressure along the great saphenous vein for a subject in the horizontal position is 0.5 mmHg per 10 cm distance.^{2, 3} The decrease can be less in the standing position at rest, whereas the pressure increases in the great saphenous vein by $1\text{-}2 \text{ mmHg}$ over the resting level⁴ while standing still after exercise, which stimulates arteriolar vasodilatation.^{2, 3}

Pressure-Volume Relationship

The behaviour of a vein depends on the structure of the three layers in the wall. In diseased veins, the venous structure changes, while an abnormal blood content such as thrombus can add an internal layer both causing more complex mechanical responses.

Volume and pressure in veins can change under different conditions. The venous volume depends on the transmural pressure, active tone of the muscular media layer and passive compliance of the adventitial layer. Especially large veins have a high passive compliance and variable venous tone, and can store blood with a low variation of transmural pressure. Together, these capacitance vessels can store $60\text{-}70\%$ of the blood volume. This is called the “reservoir effect” of the venous system. By increasing the tone of the venous wall this blood can be mobilized when needed.

In a collapsed vein with an elliptical cross-section, the first part of the pressure-volume curve represents little actual stretch of the vein wall. In the initial $0\text{-}8 \text{ mmHg}$ part of the curve, very small increments in transmural pressure produce large changes in venous volume. As the pressure increases, the venous cross-section becomes circular and further increase in volume is achieved by stretching the wall itself. Thus, in the latter part of the curve, large changes in pressure are associated with small changes in volume. A typical pressure volume curve is shown in Figure 1.1.

In some studies, volume is reported as an absolute value starting from the unloaded volume V_0 . However,

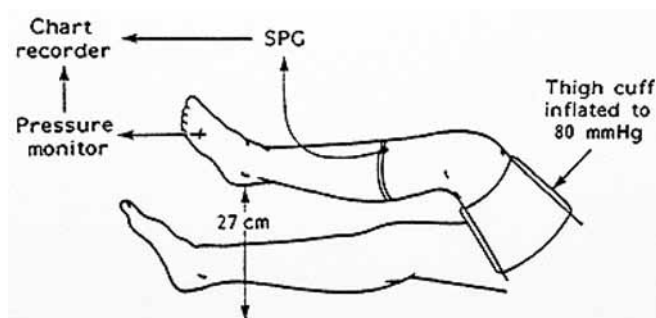

Figure 1.2.—Simultaneous measurements of pressure and volume with proximal occlusion. (SPG=strain gage plethysmograph).⁶

in order to allow a better comparison, relative volume variation $\Delta V/V_0$ can be plotted against pressure so that the plot intersects the Y-axis at the 0 value ($\Delta V=0$ when the transmural pressure is 0). The slope of a tangent at any point on the curve is the **compliance C**. As the curve changes the slope at different pressure values, the compliance also changes.⁵

Given the curve for percentage volume variation against pressure, the dimension of C is the inverse of pressure, i.e. $[P]^{-1}$ or $[L]^2 [F]^{-1}$ (mmHg^{-1}). In contrast, using the ordinary curve for volume against pressure, the compliance has a more complex dimension ($[L]^5 [F]^{-1}$).

Measurement of Venous Compliance

Measurements can be performed on veins in-vivo or on excised venous segments in an in-vitro laboratory environment. Measurements in-vitro should theoretically be greater than measurements in-vivo as in-vitro veins lack the supportive effect of surrounding tissues and muscular tone in the wall.

$\Delta V/V_0 p_t$ curves require knowledge of the **transmural pressure** p_t . This is an important point, as the **external pressure** p_e in tissue/surrounding structures is generally unknown or not easily estimated. Using the **intravenous pressure** p_i instead of p_t can be a useful approximation when $p_i \gg p_e$, so that $p_t \sim p_i$. On the contrary, when the external pressure $p_e \sim p_i$, the approximation leads to unpredictable results.

The $\Delta V/V_0 p_t$ curve **starts at the (0,0) point**, that is % volume variation is null for a null p_t . In practice, volume is equivalent to the starting volume V_0 at rest when $p_t = 0$. However, nothing can be derived about the value of V_0 . It could be that V_0 is increased, as gener-

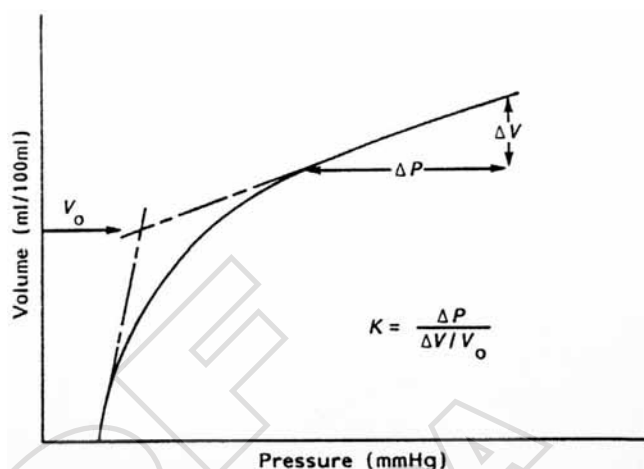

Figure 1.3.—Calculation of the elastic modulus K from the pressure-volume relationship. (P=pressure, V=volume, V_0 =initial volume).⁷

ally happens in limbs with varicose veins, so that there is generally **an increased V_0 and a stiffer less distensible compliance curve**. In practice, **varicose veins are dilated at rest and further dilation is smaller** than in a normal vein.⁵

Calculation of Elastic Modulus from the Pressure-Volume Relationship

An *in vivo* pressure-volume relationship curve is initially plotted by obtaining pressure and volume changes simultaneously following inflation of a thigh cuff (Figure 1.2). The leg is elevated so that the veins are empty prior to cuff inflation, pressure is recorded by direct measurements from a vein in the foot and volume changes are recorded by a plethysmographic technique such as strain-gauge plethysmography. A typical pressure volume curve is shown in Figure 1.3. The elastic modulus K is given by the equation

$$K = \Delta P / (\Delta V/V_0) \quad (\text{Eq 1.5}).$$

K can be converted from mmHg to SI units of Nm^{-2} using a standard conversion factor of 133.3. Since the objective is to measure the elasticity of the veins during stretching, the change in pressure (ΔP) and corresponding change in volume (ΔV) are obtained in the linear high pressure part of the pressure-volume curve (Figure 1.3). As indicated above, at low pressures during the initial filling of the vein there is a change in vol-

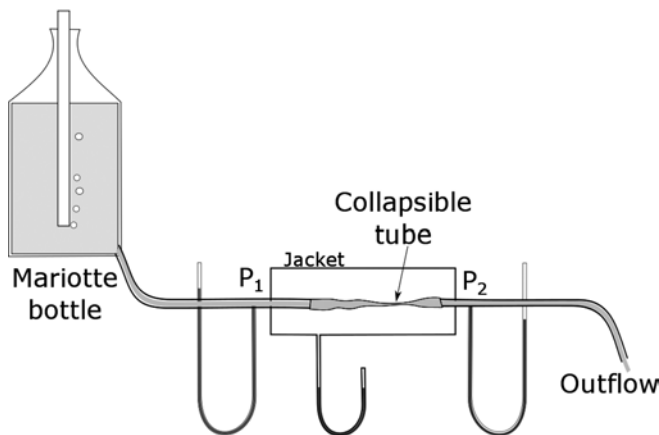

Figure 1.4.—Model for studying flow-through a horizontal collapsible tube.⁷

ume without any stretching of the wall, while changes in volume at high pressures are associated with stretching. The theoretical volume V_0 where stretching starts is obtained at the point where the extrapolated tangents of the curve for the initial filling phase (without stretching and the final phase with stretching) intersect (Figure 1.3). Using this method, the mean elastic modulus K has been found to be 13.6 (range 2.04-90.6) in 23 normal limbs, 1.13 (range 0.45-2.83) in 36 limbs with varicose veins and 1.26 (range 0.64-2.49) in 20 limbs with reflux in the deep veins.⁶ Ideally, the elastic modulus should be calculated by using the vein wall thickness, particularly as patients with chronic venous disease have a thicker vein wall. As the vein wall is anisotropic material, the elastic modulus should be estimated by correcting the equation with the Poisson's ratio.

Flow through Collapsible Tubes

The ability of veins to collapse at low transmural pressure and to vary their cross-sectional area from an ellipse to a circle with increasing pressure has been described above (see Figure. 1.1). According to the Poiseuille equation for laminar flow in a circular tube, resistance R is

$$\Delta P / Q = R = (8\eta L) / (\pi r^4) \quad (\text{Eq 1.6})$$

indicating that for a constant length L of a vessel, resistance is inversely proportional to the fourth power of the radius. Resistance also increases as the vessel col-

lapses to an elliptical shape even although the perimeter remains the same.

$$\Delta P / Q = R = (12\eta L) / (\pi r h^3) \quad h \ll r \quad (\text{Eq 1.7})$$

where r is the original vessel radius and h is the height of the residual lumen slit. A collapsed vein with the minimum diameter equal to half of the normal radius has about 10 times the resistance of the inflated circular lumen. The ability of a vein wall to stretch to increase its circumference once it becomes circular to increase its circumference reduces the resistance even further. The result of varying shape and diameter is that veins can accommodate wide ranges of flow with minimal changes in the pressure gradient. The onset of turbulence for high flow rates occurs at Reynolds numbers above 2000 for both tubular and slit like conduits computed with the smallest dimension. Using a kinematic viscosity of $0.03 \text{ cm}^2/\text{s}$ for blood, flow is limited to

$$Q_{\text{max}} = 50 \text{ cm}^3/\text{s} * D \quad (\text{Eq 1.8})$$

before the onset of turbulence causes extreme flow resistance. Thus, for a normal average vein flow rate of $25 \text{ cm}^3/\text{s}$, a conduit diameter of 0.5 cm is required. For arteries, with triple the volume flow rate only in systole, a conduit of 1.5 cm is required. A collapsed vein with a 0.2 cm slit conduit allows flow of $10 \text{ cm}^3/\text{s}$ before the onset of turbulence marked by thrill or bruit. Collapse occurs in two conditions: 1) when the limb is elevated above the CVP point, 2) when surrounding tissue is pressurized a) in a compartment by muscle contraction or b) by compression applied through the skin.

Extravascular intrathoracic pressure which is lower than atmospheric pressure or intra-abdominal pressure which is higher than atmospheric pressure have a profound effect on venous flow and alter the pressure-flow relationship. These alterations have been studied by constructing various models such as the Holt model shown in Figure 1.4.⁷ This consists of a reservoir from which fluid passes through a rigid tube, then to a collapsible tube and back to a rigid tube. The collapsible tube is within a chamber in which pressures can be varied while pressures at P_1 and P_2 can be regulated by varying the height of the reservoir or the outlet tube.

In this model P_1 is constant and higher than P_2 and

initially the pressure in the chamber (P_e) is atmospheric. Provided pressure P_2 is higher than P_e , the collapsible tube within the chamber will be distended and flow will be proportional to the pressure gradient P_1-P_2 . When P_2 decreases below P_e , the collapsible tube begins to collapse at the downstream end of the chamber and eventually flow ceases. The remainder of the tube remains open and circular. Now, if the inlet pressure is increased the collapsible tube becomes further distended and flow is resumed. Under these circumstances flow is linearly related to P_1-P_e , whatever the value of P_2 (in a waterfall P_e substitutes P_2). This model explains why flow in the femoral veins decreases as intra-abdominal pressure increases, for example during inspiration and with the Valsalva manoeuvre.

Downward flow in an inclined or vertical collapsible tube causes the tube to collapse throughout its length.⁷ In this situation, there is no transmural pressure gradient between two points along the tube and fluid behaves as if it were in free fall. When the fluid reaches a point where there is a circular cross-section because the veins have filled, then a pressure gradient will develop. This is the case when reflux occurs in varicose veins on standing immediately after the veins have been emptied by leg elevation.

Venous Valves and their Function

Venous valves in the lower limbs are located inside almost all superficial and deep veins and inside most perforating veins. They become more numerous the further the vein is from the central circulation and they are often absent in the iliac veins or inferior vena cava. They are usually bicuspid and the orientation of valve leaflets results in cardio-petal flow.⁸

In most perforating veins, leaflets are oriented towards the deep venous system while in some the valves are missing.⁹ Valves in each perforating vein are usually located below the fascia and their number varies from one to three.

Normal valve function consists of water-tight closure against a retrograde pressure gradient opposite to the direction of the leaflets. Valves remain passively open when the pressure gradient is antegrade in the same direction as the leaflets. Thus, valves are responsible for unidirectional flow to ensure unidirectional emptying of venous compartments, a physiologic draining hierarchy

of superficial to deep flow¹⁰ irrespective of posture or the intra-abdominal or intrathoracic pressures.¹¹

Valve closure also produces a dynamic fractioning of the gravitational hydrostatic pressure¹² which allows correct function of the peripheral muscle pumps, diastolic physiological draining flow and reduction of the pressure strain from the venous wall (see below).

Finally, valve closure converts peripheral muscular pump energy to gravitational energy when diastolic valve closure allows the blood volume propelled during systole to store its geometrical quota to favor venous return. Therefore, valve function cannot be dissociated from the muscle pump and the term valve-muscular pump is a meaningful descriptive term.

Valve opening

Valves are opened by antegrade flow induced by a pressure gradient oriented in the same direction as the leaflets, both at rest and in the systolic phase of muscle contraction. **Valve opening** is never total because it is hampered by the triangular thickening produced by the annulus so that flow at the valve is reduced and velocity is increased in accordance with Bernoulli's law. Accordingly, the lateral pressure spreading the leaflets decreases as blood velocity increases.¹³ In addition, the high velocity during systolic flow can form jets responsible for turbulences exceeding Reynolds number as flow enters valve sinuses bringing the leaflets even closer. Therefore, the opening width of leaflets and their vibrating free edges result from the difference between these forces.¹⁴ These turbulences wash out the tendency for stasis at the valve sinus that could lead to adherent leucocytes, platelets and coagulation factors.¹³

Valve Closure

Being not totally open,^{13, 14} a valve is quickly closed by flow reversal and a reverse trans-valve pressure gradient, rather like a draft slams a semi-open door. This closure gradient is active both at rest and during muscular contraction, closing distal valves during the systolic phase and proximal valves in the diastolic phase.

When standing still, the hydrostatic pressure developed by potential gravitational energy is always present and *vis a tergo* is then the main hydraulic pressure that drives blood towards the heart. In this position, all

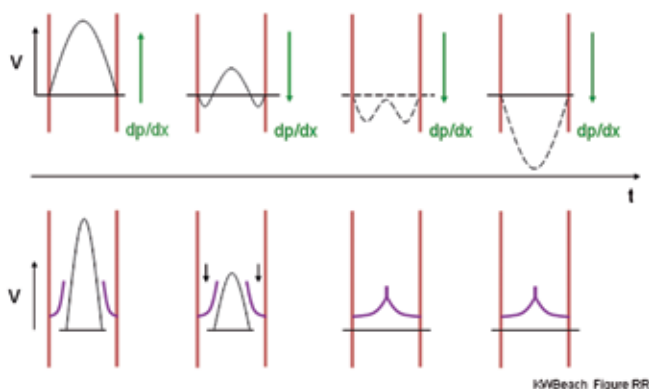

Figure 1.5.—Deceleration Valve Closure. UPPER: Steps of flow reversal in a tube from forward parabolic flow to reverse parabolic flow when the pressure gradient is reversed. LOWER: Early marginal reverse flow causes valve leaflets to coapt.

valves are open and dilated due to the hydrostatic pressure so that blood velocity is low, often less than 1 cm/sec. Blood flow often stops at peak inspiration as the hydraulic pressure gradient is reversed due to increased intra-abdominal pressure.¹⁵

During movement, the valvo-muscular pump adds its effects on flow and pressure gradient and thus on valve behavior. Systolic retrograde flow and pressure closes the distal antegrade oriented valves, and blood is aspirated during diastole by the muscle pump in proportion to the muscle diastole relaxation volume/energy, so reversing the pressure gradient to close proximal competent valves and open distal valves.

Complete valve closure occurs when the pressure gradient is applied for longer than the normal closure time for valve leaflets. This normal closure time results in a brief physiological reflux as pressure against the sinus brings the leaflets together, assisted by the reduced lateral pressure against their lumen side to reduce luminal velocity according to Bernoulli equation.¹⁴ Therefore, the valve closure time depends both on valve characteristics and the nature of the pressure gradient.

The first valve to close is the distal most closest to the pump during systole¹⁶ and proximal during diastole, referred to as dynamic fractioning of the gravitational hydrostatic pressure.¹² For example, calf pump diastole does not decrease proximal pressure at the common femoral valve but distal at the popliteal valve^{17, 18} while popliteal valve incompetence would decrease the pressure below a competent femoral valve. Another example is the centrifugal pressure gradient of the thoraco-abdominal pump

that first closes the proximal ilio-femoral valve. Therefore, topography of the valves and their distance from the pump favors diastolic closure of some valves.

The greater the inter-valve capacitance, the more valves will close, reducing muscular pump preload from the residual inter-valve volume, so as to amplify the efficacy of dynamic fractioning of the gravitational hydrostatic pressure, which can be demonstrated by a decrease in plethysmographic volume¹⁹ and pressure.²

Effect of flow profile on valve closure

There is some controversy about the relative contribution for valve closure between the Bernoulli pressure reduction²⁰ and changes in pressure gradient¹⁴. Often, veins are long and straight and flow duration is sufficient to achieve a temporary steady state parabolic laminar flow. When such parabolic flow is subject to a reversal of pressure gradient, resulting deceleration is uniform across the cross section so that slow marginal velocities are reversed before higher central velocities (Figure. 1.5). When reversed marginal velocities impinge on valve leaflets, they push the leaflets centrally into the stream to bring their edges into apposition, sealing the valve. However, if the cross-sectional diameter of the valve ring exceeds the sum of the leaflet widths, their edges cannot appose and a high velocity jet forms in the remaining orifice (Figure 1.6). The resulting reduced pressure from Bernoulli's equation can then reduce the cross-sectional diameter, now bringing the valve leaflets into apposition. Thus, the leaflets and the ring operate together to enhance valve function.

Neurogenic factors affecting valve closure

Variation in transmural pressure triggers intrinsic and extrinsic sympathetic responses affecting wall tone including the valve annulus, and this affects valve closure. Increased noradrenaline concentration perfusing the venous wall through the vasa venora causes modulation of extrinsic sympathetic tone which resets the mechanism of valve closure.^{13, 21} This may explain anecdotal observations that reflux indicating incompetent valves detected by duplex ultrasound examination are sometimes abolished if the patient is re-examined in a cold room. Similarly, this negative feedback mechanism could be responsible for primary valve incompetence in warm surroundings. .

Effect of Posture and Exercise

When a person moves from the horizontal to the standing position, the hydrostatic pressure increases equally in both arteries and veins of the foot by 80-90 mmHg, depending on the distance of the foot from the right atrium. Because the arteriovenous pressure gradient remains the same, arterial flow in a normal limb is not affected. However, flow in the veins is temporarily reduced until they become fully distended with increased venous volume. When pressure in the veins is increased by 40 mmHg or more, a veno-arteriolar reflex is elicited producing arteriolar vasoconstriction²²⁻²⁴ which together with the decreased flow results in a protective mechanism to minimize edema formation.

If the subject is not supporting himself, small muscle contractions activate muscle pumps propelling blood cephalad and emptying veins to some extent. Exercise (walking, running or tiptoeing) is very effective in emptying veins with marked reduction in hydrostatic pressure. Intramuscular pressures in the gastrocnemius and soleus muscles increase from 9-15 mmHg when they are relaxed to 215-250 mmHg during contraction.¹⁶ In normal individuals, tiptoeing causes the pressure in the foot to reduce from 80-90 mmHg to 25 mmHg. As a result, the pressure gradient from arterioles to venules is increased allowing the high blood flow required by the muscles and increased blood supply to the right atrium required to maintain an increased cardiac output.

Effect of exercise on venous pressure

Early experiments demonstrated that during walking the mean venous pressure is decreased in a normal limb by approximately 60 mmHg after 3-12 steps reaching a steady state which is approximately 22 mmHg at 1.7 miles per hour (40 steps per minute).²⁵ There is very little further decrease in pressure at higher speeds. However, below this speed the decrease in pressure (steady state) is proportional to the walking speed.^{26, 27} At the end of exercise, the pressure returns to the resting level within 30 seconds. Figure 2.7 shows a typical recording of venous pressure in a dorsal vein in the foot during standard tip-toe movements (1/sec) in a patient with varicose veins, saphenofemoral incompetence and competent valves in the deep veins. In this case, the exercise was

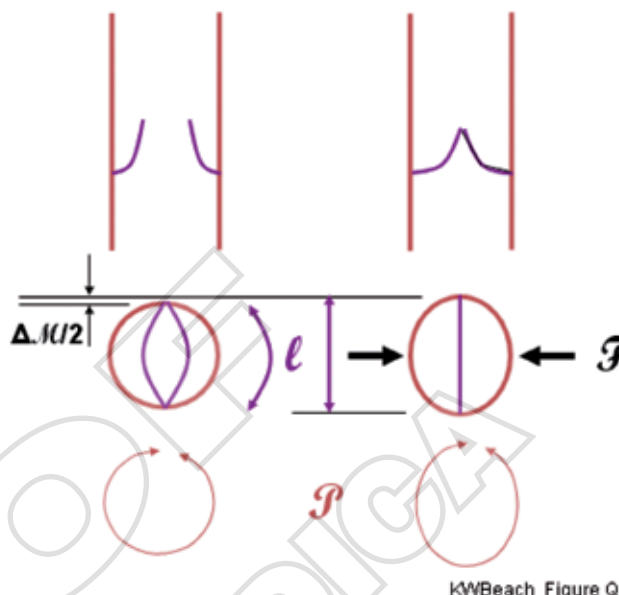

Figure 1.6.—Muscular Valve Closure. Venous valves are orientated so that the major axis of the orifice is oriented parallel to the skin. As the valve ring is compressed, the major axis expands increasing the major diameter “M” to the length of the edges “l” drawing the leaflets to apposition, closing the valve by muscular action.

repeated after inflating a 10 cm wide pneumatic cuff just below the knee to occlude the superficial veins.²⁸ By abolishing venous reflux, the pressure recording became completely normal.

If the log_e of the mean venous pressure after each step is plotted against time it produces a straight line indicating that the decrease in pressure is an exponential curve produced by a constant pressure reduction fraction.²⁹ At the beginning of the exercise, the volume of blood expelled is much more than the inflow per step (blood entering the veins via the microvascular bed). However, the expelled volume decreases with each step reaching a steady state in hydrostatic pressure when the volume expelled per step equals the volume inflow (see below).

In the example shown in Figure 1.7 when reflux in the great saphenous vein was eliminated by the cuff below the knee, the steady state was at a pressure of 25 mmHg. In the first part of the experiment when reflux in the great saphenous vein was not abolished, the steady state was at pressure of 55 mmHg. At this point, the inflow per step was high consisting of blood inflow through the microvascular bed as well as reflux down the great saphenous vein.

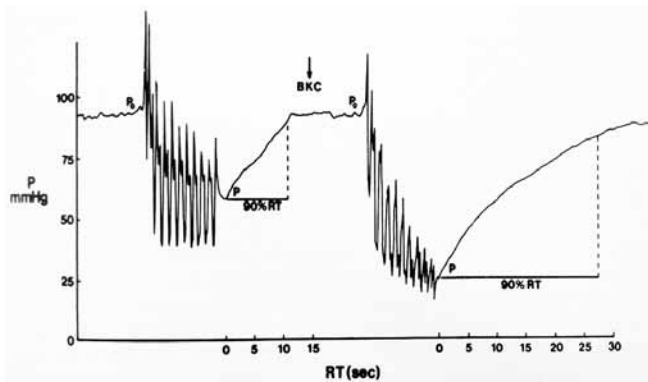

Figure 1.7.—Recording of ambulatory venous pressure at rest and during ten tiptoe movements in a patient with varicose veins and saphenofemoral incompetence. The first recording was without and the second with a below knee cuff which occluded the great and small saphenous veins normalizing the ambulatory venous pressure (P) and the refilling time (90% RT).

Effect of Exercise on Venous Volume

The effect of exercise on volume changes have been studied in the past by foot volumetry³⁰ and strain gauge plethysmography.³¹ More recently, air plethysmography has provided volume changes in the whole leg so that venous volume, ejected volume and residual venous volume can be measured in ml, reflux in ml/sec, with ejection fraction and residual venous fraction as derived measurements.³²

Figure 1.8 shows the volume changes in the leg as a result of several maneuvers. Initially the subject is in the horizontal position with the leg elevated (a) to empty the veins and obtain a baseline. On standing (b) the volume increases to a new plateau. The increase in volume represents the venous volume (VV) which is 100-150 ml in normal limbs. The venous filling index (VFI) is defined as the ratio of 90% of the VV divided by the time taken to achieve 90% of filling ($VFI = 90\%VV/VFT90$) and is expressed in ml/sec. In normal limbs VFI is 1- 2 ml/sec being the inflow from the microvascular bed.³³ By asking the subject to do one tiptoe movement (c) one can measure the ejected volume (EV) which is 65-130 ml depending on the size of the calf, and ejection fraction ($EF = (EV/VV) \times 100$). The range of EF in normal limbs is 65-90%. By asking the subject to perform 10 tiptoe movements one can measure the residual volume (RV) and calculate the residual volume fraction ($RVF = (RV/VV) \times 100$) (Figure 1.8). The RVF in normal limbs is 5-30% and is proportional to the ambulatory venous pressure after 10 tiptoe movements.³⁴

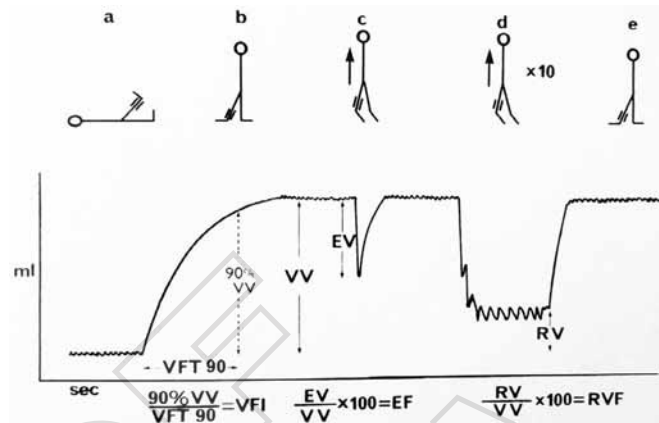

Figure 1.8.—Diagrammatic representation of typical recording of venous volume changes during standard sequence of postural changes and exercise. (a) Patient in supine position with leg elevated 45 degrees; (b) patient standing with weight on non-examined leg; (c) single tiptoe movement; (d) ten tiptoe movements; (e) return to resting standing position as b. VV=venous volume; VFT=venous filling time; VFI=venous filling index; EV=eject volume; EF=ejection fraction; RV=residual venous volume; RVF=Residual venous fraction.³²

Venous Capacitance and Resistance

Figure 1.9 shows inflow and outflow curves for calf volume and pressure obtained simultaneously.^{35, 36} Volume changes are obtained using air-plethysmography and pressure by direct puncture of a vein on the dorsum of the foot. Inflow curves are obtained by inflating a proximal thigh cuff to 80 mmHg. After a plateau is reached, the thigh cuff is suddenly released and the outflow curve is recorded. Flow Q can be calculated at any point on the volume outflow curve from the tangent at that point. The resistance R is calculated by dividing the corresponding pressure P from the pressure outflow curve by the flow Q ($R = P/Q$). The units are mmHg/ml/min. By calculating R at several points along the outflow curve and plotting them against pressure, it is possible to demonstrate how resistance changes with different pressures, which determine the cross-sectional area of the vein. Figure 1.10 shows two such plots, one from a patient with outflow obstruction (A) and the other from a normal limb (B). It can be seen that the resistance-pressure relationship is not linear. Resistance is low at high pressure when the veins and collateral channels are distended. As the pressure decreases, the vein wall becomes less stretched and eventually collapses reducing the cross-sectional area so that the resistance increases.³⁵

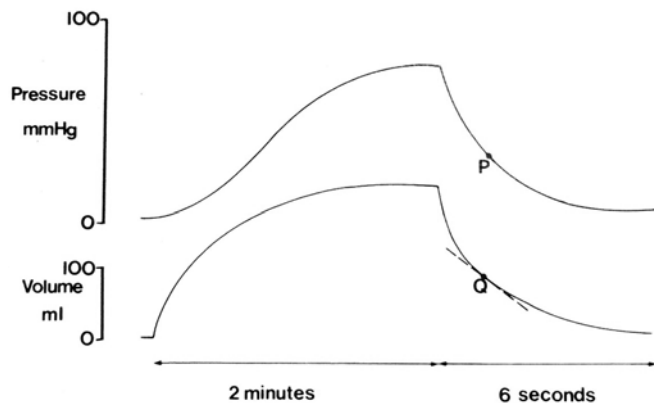

Figure 1.9.—Pressure and volume venous occlusion inflow and outflow curves. Pressure is recorded with a needle in a foot vein and volume with the air plethysmograph.

Factors Promoting Venous Flow

The forces that promote cephalad venous flow are generated by the *vis a tergo*, muscular pumps (foot, calf and thigh pumps) and thoraco-abdominal pump.

Vis a Tergo

Vis a tergo is a Latin term which literally means *force acting from the rear*. It corresponds to the residual pressure coming from the capillary bed as a result of left ventricular contractions. In the absence of the muscle pumps, this pressure can approach the value of arterial pressure. In supine subjects at rest, thigh-cuff pressures of at least 80 mmHg are required to occlude venous return.³⁷

The Foot Pump

During walking, the plantar plexus is able to overcome the pressure of the column of blood within the deep venous system of the calf.^{16, 38} The foot pump is activated during walking by compression of the lateral plantar veins whose middle portion is dilated acting like a reservoir,³⁹ due to body weight and contraction of the plantar muscles. Every step squeezes a small volume of 20-30 ml,⁴⁰ but the pumping mechanism is very effective.

During walking, the foot is in contact with the ground for 60% of the time and remains off the ground 40%.⁴¹ The foot architecture is such that the weight-bearing takes place almost entirely on the ball of the toes, the heel and the lateral part of the plantar surface of the foot. The medial part remains pressure free. Thus, the plantar veins, which are located here, are protected from direct compression except in subjects with flat feet.⁴¹

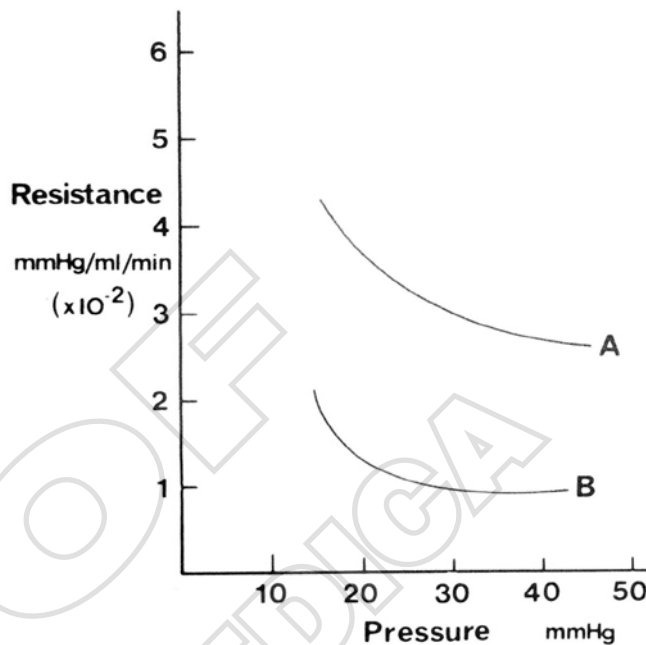

Figure 1.10.—Resistance plotted against pressure for a limb with out-flow obstruction (A) and a normal limb (B).

During normal walking, the three vein-pumping systems (foot, calf and thigh) compress in sequence to promote blood venous return. Even moderate muscular movements of the legs in the seated position may activate the pumping mechanism and thus significantly reduce distal mean vein pressure.⁴²

Although synchronized with the calf pumps, the outflow from the foot plexus is independent of proximal calf muscle contraction. This is possible because the proximal calf pump and foot pump work “in parallel” voiding their volumes separately into the main duct (popliteal vein) and not “in series”.

Video-phlebography³⁸ has demonstrated that the preferential outflow for the foot pump is the posterior tibial vein which is in its direct continuity; the peroneal, anterior tibial and saphenous veins are alternative outflow paths. Mechanical compression of the plantar venous plexus produced a mean peak-velocity of 123 ± 71 cm/sec in the posterior tibial veins, 29 ± 26 cm/sec in the peroneal veins, and 24 ± 14 cm/sec in the anterior tibial veins.⁴³

The Proximal Muscle Pumps

The most active pump in the limb results from soleal and gastrocnemius muscle contractions, for

they are rich in venous sinuses that are strongly squeezed during the impulse phase of the step when pressure exceeds 200 mm Hg and calf blood volume decreases by 80%.⁴⁴

Simultaneous pressure measurements in the posterior tibial and great saphenous veins in healthy people were performed by Arnoldi.⁴⁵ When the calf muscles contracted, the pressure rose in all veins of the lower limb and the increase was three times greater in muscular than in superficial veins. Although the systolic pressure increased in both sets of veins, the peak value in the posterior tibial vein was higher than in the great saphenous vein by 44 mm Hg during the first tramp; the difference diminished during following tramps. In patients with varicose veins, the difference reached a value of just 12 mm Hg during the first tramp.⁴⁵ During muscle relaxation the pressure difference reversed. Pressure in the posterior tibial vein decreased more than in the great saphenous vein and saphenous reflux significantly increased this difference.⁴⁶

During muscle contraction (systole), a strong pressure gradient between deep calf veins and the popliteal vein causes rapid efflux of blood from the calf to the thigh. Venous pressure exceeds intramuscular pressures in calf compartments in most step phases but competent venous valves prevent retrograde flow. On subsequent muscle relaxation (diastole), venous pressure falls below the pressure at rest. The fall is greater in deep veins, less in superficial veins and negligible in the popliteal vein. In this phase, perforating veins allow blood flow from superficial to deep veins whereas competent valves prevent backflow from the popliteal vein to deep calf veins.³⁹

Action of the muscle pumps during walking

The distal calf pump is activated at the beginning of a step. This process is initiated by dorsiflexion of the foot as the leg is lifted. The anterior compartment muscles contract and empty their veins. Dorsiflexion passively stretches the Achilles tendon and thus empties blood from the lower portions of the peroneal and posterior tibial veins. As the foot strikes the ground, weight bearing activates a second phase which is the foot pump described above. Plantar flexion initiates a third phase as the foot comes up on its toes. Muscles of the posterior compartments, particularly the gastrocnemius and so-

leus, contract to empty the proximal venous reservoir. Plantar flexion also tenses and shortens the Achilles tendon which maintains pressure on the distal portion of the calf muscle pump.³⁸

In more detail, during passive or active dorsiflexion of the ankle, the bulk of the calf muscles descend within the fascia sheath to expel blood from the distal veins like a piston. This gives space to blood coming from the foot pump due to weight bearing that will feed in preference to the posterior tibial veins. These two systems are "in series". The foot pump finds low resistance when expelling blood to the deep veins (a favourable gradient), whereas the proximal pump is very strong so that it can empty a high although variable volume of blood to the popliteal vein, even in the absence of a favourable gradient. It works "in parallel" with the more distal complex.

The distal leg pump may become insufficient, i.e., unable to void the blood volume coming from the perforating veins during diastole because of a reflux or functional overflow (excess of volume) or an organic or functional obstruction (excess of pressure). In this instance, the foot pump will redirect blood through alternative sites to the saphenous veins (marginal veins at foot level) through the foot perforating veins which are normally valveless.

Many of the records made by Pegum and Fegan⁴⁷ by cannulating deep and superficial veins through an incision at the first interosseous space show that when the pressure in the deep veins rose to exceed the superficial pressure, the superficial pressure then began to also rise but to a lesser extent. This suggests that pressure in the deep veins of the sole was being transmitted to superficial veins (dorsal venous arch) by perforating veins along a pressure gradient.

Summary of Flow and Pressure Changes in Veins of Normal Lower Limbs

Flow in superficial veins of the lower limb recorded with an electromagnetic flowmeter on the great saphenous vein during motionless standing is practically zero. However, slight movements of the body and even speech or laughter initiate short flow waves in a proximal direction.^{48, 49} With the subject in the supine position, venous flow in the common femoral vein is phasic with respiration. Increased intra-abdominal pres-

sure during inspiration, Valsalva manoeuvre or external compression of the abdomen can cause slowing or cessation of flow. In the absence of any limb movement, the driving force for blood flow is the hydraulic pressure derived mainly from the *vis a tergo* modified by respiration.

When the subject is at rest, pressure is stable and corresponds to the hydrostatic venous pressure. In the supine position, the mean venous pressure at the ankle is 10-12 mmHg; in the sitting position 50-60 mmHg, and during motionless standing 80-90 mmHg. During motionless standing, the pressure is the same in superficial and deep veins provided that measurements are made at the same level.

During exercise, flow and pressure vary according to the phase of the walking cycle. During the systolic phase, flow within perforating veins ceases and blood is expelled proximally. Höjensgard and Stürup² performed simultaneous pressure recordings in posterior tibial and great saphenous veins in healthy people and provided conclusive proof that deep and superficial veins of the lower leg behave as conjoined vessels as the pressure curves in the posterior tibial and great saphenous veins were nearly identical. This provided evidence that communicating channels between them enable quick equilibration of pressure once exercise stops.

In general, the direction of flow during the walking cycle is towards the heart both in superficial and deep veins. There is general agreement that during the relaxation phase, the direction of flow is from superficial to deep veins through perforating veins. However, the direction of flow in normal perforating veins remains a debated issue. Sarin et al.⁵⁰ detected outward flow in communicating veins in 21% of healthy persons on calf compression using duplex ultrasound scanning. They claimed that "there is flow in both directions within medial calf perforator, and within a single perforator local conditions can result in flow in either direction.... the definition of incompetent perforator needs to be carefully re-evaluated ...demonstration of outward flow within medial calf perforators does not confer abnormality but rather is a variation of normal". This statement has been disputed by a subsequent study which demonstrated that deep to superficial flow in perforating veins in normal individuals tested in the sitting posi-

tion using duplex ultrasound is a rare phenomenon.⁵¹ More work is needed in this area.

References

1. Ludbrook J. Aspects of venous function in the lower limbs. Springfield, IL: Charles C Thomas, 1966.
2. Hojensgard IC, Sturup H. Static and dynamic pressures in superficial and deep veins of the lower extremity in man. *Acta Physiol Scand* 1952;27(1):49-67.
3. Ludbrook J. Functional aspects of the veins of the leg. *Am Heart J* 1962;64:706-13.
4. Ludbrook J. Valvular Defect in Primary Varicose Veins: Cause or Effect? *Lancet* 1963;2(7321):1289-92.
5. Passariello F. Compliance: physical and biological features. *Acta Phlebologica* 2013;14(1):9-13.
6. Clarke H, Smith SR, Vasdekis SN, Hobbs JT, Nicolaidis AN. Role of venous elasticity in the development of varicose veins. *Br J Surg* 1989;76(6):577-80.
7. Holt JP. Flow through collapsible tubes and through in situ veins. *IEEE Trans Biomed Eng* 1969;16(4):274-83.
8. Ludbrook J, Beale G. Femoral venous valves in relation to varicose veins. *Lancet* 1962;1(7220):79-81.
9. Cockett FB. The pathology and treatment of venous ulcers of the leg. *Br J Surg* 1955;43(179):260-78.
10. Franceschi C, Zamboni P. Principles of Venous Hemodynamics. New York: Nova Science Publishers, 2009.
11. Bollinger A, Wirth W, Brunner U. Valve agenesis and dysplasia of leg veins. Morphological and functional studies. *Schweiz Med Wochenschr* 1971;101(37):1348-53.
12. Franceschi C. Dynamic fractionizing of hydrostatic pressure, closed and open shunts, vicarious varicose evolution: how these concepts made the treatment of varices evolve? *Phlebologie* 2003;56(1):61-6.
13. Calota F, Mogoanta SS, Vasilescu MM, Vasile I, Pasalega M, Stoicesa MC, et al. The valvular segment of the lower limbs venous system: anatomical, physiological and physiopathological aspects. *Rom J Morphol Embryol* 2010;51(1):157-61.
14. Lurie F, Kistner RL, Eklof B, Kessler D. Mechanism of venous valve closure and role of the valve in circulation: a new concept. *J Vasc Surg* 2003;38(5):955-61.
15. Franceschi C. Investigation vasculaire par ultrasonographie Doppler. Collection médecine ultrasonore Paris: Masson Editeur, 1977.
16. Ludbrook J. The musculo-venous pumps of the human lower limb. *Am Heart J* 1966;71(5):635-41.
17. Recek C, Pojer H. Ambulatory pressure gradient in the veins of the lower extremity. *Vasa* 2000;29(3):187-90.
18. Bjordal R. Simultaneous pressure and flow recordings in varicose veins of the lower extremity. A haemodynamic study of venous dysfunction. *Acta Chir Scand* 1970;136(4):309-17.
19. Stick C, Hiedl U, Witzleb E. Venous pressure in the saphenous vein near the ankle during changes in posture and exercise at different ambient temperatures. *Eur J Appl Physiol Occup Physiol* 1993;66(5):434-8.
20. van Bemmelen PS, Beach K, Bedford G, Strandness DE, Jr. The mechanism of venous valve closure. Its relationship to the velocity of reverse flow. *Arch Surg* 1990;125(5):617-9.
21. Crotty TP. The venous valve agger and plasma noradrenaline-mediated venodilator feedback. *Phlebology* 2007;22(3):116-30.
22. Beaconsfield P, Ginsburg J. Effect of changes in limb posture on peripheral blood flow. *Circ Res* 1955;3(5):478-82.
23. Mellander S, Oberg B, Odelram H. Vascular Adjustments to Increased Transmural Pressure in Cat and Man with Special Reference to Shifts in Capillary Fluid Transfer. *Acta Physiol Scand* 1964;61:34-48.
24. Henriksen O. Local reflex in microcirculation in human subcutaneous tissue. *Acta Physiol Scand* 1976;97(4):447-56.
25. Pollack AA, Wood EH. Venous pressure in the saphenous vein at the ankle in man during exercise and changes in posture. *J Appl Physiol* 1949;1(9):649-62.

26. Hjelmsstedt A. The pressure in the veins of the dorsum of the foot in quiet standing and during exercise in limbs without signs of venous disorder. *Acta Chir Scand* 1968;134(3):235-44.
27. Hjelmsstedt A. Pressure decrease in the dorsal pedal veins on walking in persons with and without thrombosis. A study of a fracture series. *Acta Chir Scand* 1968;134(7):531-9.
28. Nicolaides AN, Zukowski AJ. The value of dynamic venous pressure measurements. *World J Surg* 1986;10(6):919-24.
29. Hosoi Y, Zukowski A, Kakkos SK, Nicolaides AN. Ambulatory venous pressure measurements: new parameters derived from a mathematical hemodynamic model. *J Vasc Surg* 2002;36(1):137-42.
30. Thulesius O, Norgren L, Gjöres JE. Foot-volumetry, a new method for objective assessment of edema and venous function. *Vasa* 1973;2(4):325-9.
31. Barnes RW, Ross EA, Strandness DE, Jr. Differentiation of primary from secondary varicose veins by Doppler ultrasound and strain gauge plethysmography. *Surg Gynecol Obstet* 1975;141(2):207-11.
32. Christopoulos DG, Nicolaides AN, Szendro G, Irvine AT, Bull ML, Eastcott HH. Air-plethysmography and the effect of elastic compression on venous hemodynamics of the leg. *J Vasc Surg* 1987;5(1):148-59.
33. Christopoulos D, Nicolaides AN, Szendro G. Venous reflux: quantification and correlation with the clinical severity of chronic venous disease. *Br J Surg* 1988;75(4):352-6.
34. Nicolaides A, Christopoulos D, Vasdekis S. Progress in the investigation of chronic venous insufficiency. *Ann Vasc Surg* 1989;3(3):278-92.
35. Nicolaides AN. Investigation of chronic venous insufficiency: A consensus statement (France, March 5-9, 1997). *Circulation* 2000;102(20):E126-63.
36. Labropoulos N, Volteas N, Leon M, Sowade O, Rulo A, Giannoukas AD, *et al*. The role of venous outflow obstruction in patients with chronic venous dysfunction. *Arch Surg* 1997;132(1):46-51.
37. Lattimer CR, Kalodiki E, Azzam M, Geroulakos G. Pneumatic thigh compression reduces calf volume and augments the venous return. *Phlebology* 2014;4.
38. Gardner AM, Fox RH. The venous pump of the human foot--preliminary report. *Bristol Med Chir J* 1983;98(367):109-12.
39. Uhl JF, Gillot C. Anatomy of the foot venous pump: physiology and influence on chronic venous disease. *Phlebology* 2009;27(5):219-30.
40. Scurr JH, Smith PC. The muscular pump of the foot: physiological and clinical importance. *Phlebologie* 1993;46(2):209-15.
41. Murray MP, Drought AB, Kory RC. Walking Patterns of Normal Men. *J Bone Joint Surg Am* 1964;46:335-60.
42. Strandén E. Dynamic leg volume changes when sitting in a locked and free floating tilt office chair. *Ergonomics* 2000;43(3):421-33.
43. White JV, Katz ML, Cisek P, Kreithen J. Venous outflow of the leg: anatomy and physiologic mechanism of the plantar venous plexus. *J Vasc Surg* 1996;24(5):819-24.
44. Kuster G, Lofgren EP, Hollinshead WH. Anatomy of the veins of the foot. *Surg Gynecol Obstet* 1968;127(4):817-23.
45. Arnoldi CC. Venous pressure in the leg of healthy human subjects at rest and during muscular exercise in the nearly erect position. *Acta Chir Scand* 1965;130(6):570-83.
46. Recek C, Koudełka V. Circulatory effect of saphenous reflux in primary varicose veins *Phlebologie* 1979;32(4):407-14.
47. Pegum JM, Fegan W. Physiology of venous return from the foot. *Cardiovasc Res* 1967;1(3):249-54.
48. Björkdal RI. Pressure patterns in the saphenous system in patients with venous leg ulcers. The proximal saphenous occlusion test as a guide to diagnosis, therapy and prognosis. *Acta Chir Scand* 1971;137(6):495-501.
49. Björkdal RI. Circulation patterns in incompetent perforating veins in the calf and in the saphenous system in primary varicose veins. *Acta Chir Scand* 1972;138(3):251-61.
50. Sarin S, Scurr JH, Smith PD. Medial calf perforators in venous disease: the significance of outward flow. *J Vasc Surg* 1992;16(1):40-6.
51. Labropoulos N, Mansour MA, Kang SS, Gloviczki P, Baker WH. New insights into perforator vein incompetence. *Eur J Vasc Endovasc Surg* 1999;18(3):228-34.

Chapter 2. Hemodynamic Changes in Acute Deep Vein Thrombosis

Introduction

The hemodynamic changes that occur in patients with acute deep vein thrombosis (DVT) depend on the level of thrombosis, its extent and whether thrombus progression is slow or rapid. It is the severity of the hemodynamic disturbance that will determine the development and magnitude of presenting symptoms and signs. The main hemodynamic changes are the result of obstruction rather than valvular incompetence, which happens later during thrombus organization and valve destruction. Plethysmographic methods in the 1960s and 1970s demonstrated that in 70% of the patients with acute DVT confirmed by venography, findings were purely obstructive with associated reflux only in a minority.¹⁻⁵

Localized DVT in one or two veins in the calf as shown by venography is often asymptomatic producing mild ankle edema and calf tenderness in only 50% of patients.⁶ In contrast, extensive calf DVT involving the popliteal vein is often symptomatic. However, as clinicians know, gross edema will not occur as long as the thrombus is confined to the femoral vein distal to the junction with the deep femoral or the great saphenous veins which act as collateral channels. In contrast, when thrombosis involves these junctions or occurs proximal to them, massive edema is likely to occur.⁷ Also, rapid progression of thrombus proximally may not allow development of a collateral circulation and can result in venous gangrene.

The following hemodynamic changes occur: increased outflow resistance with decreased venous volume and decreased maximum venous outflow, increased venous pressure to a degree determined by the absence or presence of collateral flow patterns, changes in blood velocity, changes in arterial inflow which is increased in most patients but decreased in those with cerulea dolens or venous gangrene, and hemodynamic changes in the microcirculation resulting in interstitial fluid accumulation.

The aim of this section is to present the mechanism and magnitude of these hemodynamic changes and to indicate their pathophysiological and clinical significance.

Increased outflow resistance

Plethysmography using water,³ strain gauge^{2, 4, 8, 9} or air-filled techniques^{1, 10} have demonstrated a reduced venous volume (VV) in the presence of DVT. VV was defined as the increase in leg volume in response to a standardized venous congestion pressure produced by inflating a thigh cuff with the patient supine and leg elevated above the level of the heart. Earlier studies¹¹ demonstrated that the pressure in veins distal to the occluding cuff rises to the same level as the thigh cuff within 0.5 to 2 minutes. In one study using strain gauge, the VV in limbs with DVT was 3.1 ± 0.8 ml/100 ml of tissue compared with 4.2 ± 0.8 ml/100 ml in normal limbs at a congestion pressure of 70 mmHg;³ it was 1.1 ± 0.6 compared with 2.1 ml/100 ml in normal limbs at a congestion pressure of 80 mmHg.² When air plethysmography was used in patients with acute iliofemoral DVT, the absolute VV in ml was found to be 10 ml (95% CI 5 to 15) in the presence of calf and popliteal involvement and 25 ml (95% CI 20 to 30) if the calf and popliteal veins were not involved; this compares to 110 ml (95% CI 80 to 140) in healthy volunteers.¹² The explanations provided for the reduced VV are reduced capacity of the veins when they are filled with thrombus, partial filling already present in the veins prior to inflating the thigh cuff in patients with proximal obstruction and reduced distensibility of the veins as a result of extravascular tissue pressure due to edema. Which of these is the predominant factor depends on the site and extent of the DVT.

Maximum venous outflow (MVO) is also reduced in patients with acute DVT.¹³ MVO is a measure of the initial maximum venous emptying when the pressure in a proximal pneumatic cuff is released. MVO (dv/dt or flow Q) is obtained from the tangent on the initial part of the volume outflow curve when the thigh cuff is released. It is directly proportional to the pressure gradient between the pressure in leg veins and the pressure in the IVC which is close to zero, and inversely proportional to the resistance offered by the popliteal, thigh, iliac and collateral veins ($Q = P/Q$). MVO was 32 ± 17 ml/100ml/min in the presence of DVT compared with 87 ± 14 ml/100 ml/min in normal limbs at a congestion pressure of 80 mmHg.² At a congestion pressure of 50 mmHg it was 23 ± 8 ml/100ml/min compared with 78 ± 22 ml/100 ml/min in normal limbs in one study⁴ and 12 ± 8 ml/100ml/min compared with 41 ± 11 ml/100 ml/min in normal limbs in another study.²

When air plethysmography was used in patients with acute iliofemoral DVT, the absolute outflow fraction in ml was found to be 10 ml (95% CI 5 to 15) in the presence of calf and popliteal involvement and 25 ml (95% CI 20 to 30) if the calf and popliteal veins were not involved.¹²

The above findings were the basis for plethysmographic methods developed and used extensively for non-invasive diagnosis of DVT before duplex scanning became available in the 1970s and early 1980s.^{9, 14-16} By plotting MVO on the vertical axis against VV, a scattergram was produced with a good separation between symptomatic patients with DVT proven by venography and asymptomatic patients with normal deep veins. A meta-analysis which included 78 studies showed that sensitivity and specificity were 75% and 90% for impedance plethysmography, 83% and 81% for strain-gauge plethysmography and 85% and 91% for air-plethysmography.¹⁷

Increase in Venous Pressure

In patients with acute DVT, venous pressure has been measured in the supine and standing positions as well as during exercise. In 25 limbs with DVT, it was 16.6 ± 6.8 mmHg in the supine position compared with 6.7 ± 1.3 in normal limbs. In the standing position, venous pressures were the same in both groups: 93.8 ± 3.4 and 90.0 ± 7.4 mmHg respectively. However, during a tiptoeing exercise there was a decrease to 91.1 ± 18.5 mmHg in the DVT group and to 35.4 ± 8.9 mmHg in normal limbs.¹⁸ When air-plethysmography was used, the ejected volume as a result of one tip-toe movement was 15 ml (95% CI 5 to 25) in those with DVT compared with 90 ml (95% CI 75 to 125) in normal limbs.¹²

In another study, venous pressure in the foot in the horizontal position was in the range of 8.5 to 18.4 mmHg when thrombosis was confined to the calf and/or popliteal vein, 20-51 mmHg when thrombosis involved the superficial femoral vein and 32-83 mmHg in patients with iliofemoral DVT.⁷ In this series, edema was rarely present if venous pressure was less than 20 mmHg but always present when venous pressure was higher than 50 mmHg.

In patients with iliofemoral DVT, the ambulatory venous pressure (AVP) in the foot increases with exercise from 80 mmHg to well over 100 mmHg.¹⁹ It decreases

to 28-40 mmHg after complete thrombolysis, 50-66 mmHg after partial lysis and 68-78 in the absence of venographic improvement.¹⁹

Changes in Velocity

Venous flow and velocity are phasic with respiration in normal limbs in the horizontal position. This phenomenon is the result of increased intra-abdominal pressure during inspiration associated with contraction of the diaphragm. The increased intra-abdominal pressure is transmitted to the IVC and iliac veins decreasing the pressure gradient between the leg or thigh and the IVC. During expiration, the reverse occurs and an increased pressure gradient results in increased flow and velocity. In acute iliofemoral DVT, the outflow resistance increases much more than the respiratory pressure fluctuations so that this becomes the limiting factor and flow in the main axial veins distal to the obstruction ceases to be phasic and slows down. In contrast, flow and velocity in the collateral circulation becomes increased with high velocities. This is why absence of phasic velocity with respiration and increased velocity in collateral veins is a useful finding which alerts the ultrasonographer to look for a more proximal obstruction.

Changes in Arterial Inflow and Skin Temperature

Arterial inflow is increased in the majority of patients with acute DVT.³ This may be a result of perivenous inflammation but the exact mechanism is not known. The increased arterial blood flow and diversion of venous flow into superficial collateral veins invariably result in increased skin temperature in excess of 0.7 degrees centigrade compared with the normal leg.²⁰ Absence of such increase in temperature has been used in the past to exclude DVT in patients with symptoms and signs suggestive of DVT so as to spare them from unnecessary further investigations. Thermography and liquid crystal thermography were used in the 1970s and 1980s in routine clinical practice.²⁰⁻³¹ The value of thermography was based on the fact that when the test was normal, the likelihood of DVT being present was less than 5%. However, if the test was positive it provided an indication for further investigation to confirm the diagnosis of DVT because many other conditions could produce warm skin.

Changes in the Microcirculation

In patients with massive DVT and associated massive edema, up to 50% of the blood volume may be lost into the affected limb.³² Hypotension and high venous resistance transmitted to the microcirculation increase capillary filtration. The increased extracellular fluid compresses the lymphatic vessels^{32, 33} preventing removal of proteins from interstitial tissues. This in turn increases the osmotic pressure in the interstitial space further decreasing the ability to absorb fluid into the circulation. Interstitial pressure as high as 42 mmHg has been found in experimental animals.³⁴ Such high interstitial pressure with a low arterial pressure is likely to produce venous gangrene.

References

1. Sakaguchi S, Tomita T, Endo I, Ishitobi K. Functional segmental plethysmography: a new venous function test. (Preliminary report). *J Cardiovasc Surg (Torino)* 1968;9(1):87-98.
2. Sakaguchi S, Ishitobi K, Kameda T. Functional segmental plethysmography with mercury strain gauge. *Angiology* 1972;23(3):127-35.
3. Dahn I, Eiriksson E. Plethysmographic diagnosis of deep venous thrombosis of the leg. *Acta Chir Scand Suppl* 1968;398:33-42.
4. Gothlin J, Hallbook T. Plethysmography and phlebography in the diagnosis of acute deep venous thrombosis. *Radiology* 1971;11(4):137-47.
5. Barnes RW, Collicott PE, Summer DS, Strandness DE, Jr. Noninvasive quantitation of venous hemodynamics in the postphlebotic syndrome. *Arch Surg* 1973;107(5):807-14.
6. Kakkar V. The diagnosis of deep vein thrombosis using the 125 I fibrinogen test. *Arch Surg* 1972;104(2):152-9.
7. Deweese JA, Rogoff SM. Phlebographic patterns of acute deep venous thrombosis of the leg. *Surgery* 1963;53:99-108.
8. Barnes RW, Collicott PE, Mozerky DJ, Summer DS, Strandness DE, Jr. Noninvasive quantitation of maximum venous outflow in acute thrombophlebitis. *Surgery* 1972;72(6):971-9.
9. Barnes RW, Hokanson DE, Wu KK, Hoak JC. Detection of deep vein thrombosis with an automatic electrically calibrated strain gauge plethysmograph. *Surgery* 1977;82(2):219-23.
10. Bygdeman S, Aschberg S, Hindmarsh T. Venous plethysmography in the diagnosis of chronic venous insufficiency. *Acta Chir Scand* 1971;137(5):423-8.
11. Siggard-Andersen J, Petersen FB, Kjeldsen K. Volume changes of the calf during ten minutes' venous stasis. *Acta Med Scand* 1968;184(4):289-92.
12. Christopoulos D, Tachtsi M, Pitoulias G, Belcaro G, Papadimitriou D. Hemodynamic follow-up of iliofemoral venous thrombosis. *Int Angiol* 2009;28(5):394-9.
13. Kalodiki E, Nicolaidis AN. Air-plethysmography for the detection of acute DVT; New criteria. *Vasc Surg* 1997;31(2):123-9.
14. Hallbook T, Ling L. Plethysmography in the diagnosis of acute deep vein thrombosis. *Vasa* 1974;3(3):263-8.
15. Boccalon H, Reggi M, Lozes A, Canal C, Jausseran JM, Courbier R, *et al.* The value of spectral frequency analysis by Doppler examination (author's transl) *J Mal Vasc* 1981;6(1):55-9.
16. Bounameaux H, Krahenbuhl B, Vukanovic S. Diagnosis of deep vein thrombosis by combination of Doppler ultrasound flow examination and strain gauge plethysmography. An alternative to venography only in particular conditions despite improved accuracy of the Doppler method. *Thromb Haemost* 1982;47(2):141-4.

17. Locker T, Goodacre S, Sampson F, Webster A, Sutton AJ. Meta-analysis of plethysmography and rheography in the diagnosis of deep vein thrombosis. *Emerg Med J* 2006;23(8):630-5.
18. Husni EA, Ximenes JO, Goyette EM. Elastic support of the lower limbs in hospital patients. A critical study. *Jama* 1970;214(8):1456-62.
19. Kriessmann A, Theiss W, Lutlisky L, Wirtzfeld A, Seifert W, Grunberg G. Fibrinolytic therapy in deep venous thrombosis of the upper and lower extremity *Fortschr Med* 1977;95(13):858-66.
20. Cooke ED, Picher MF. Deep vein thrombosis: preclinical diagnosis by thermography. *Br J Surg* 1974;61(12):971-8.
21. Leiviska T, Perttala Y. Thermography in diagnosing deep venous thrombosis of the lower limb. *Radiol Clin (Basel)* 1975;44(5):417-23.
22. Bergqvist D, Efsing HO, Hallbook T. Thermography. A noninvasive method for diagnosis of deep venous thrombosis. *Arch Surg* 1977;112(5):600-4.
23. Bystrom LG, Larsson T, Lundell L, Abom PE. The value of thermography and the determination of fibrin-fibrinogen degradation products in the diagnosis of deep venous thrombosis. *Acta Med Scand* 1977;202(4):319-22.
24. Nilsson E, Sunden P, Zetterquist S. Leg temperature profiles with a simplified thermographic technique in the diagnosis of acute venous thromboses. *Scand J Clin Lab Invest* 1979;39(2):171-7.
25. Watz R, Ek I, Bygdeman S. Noninvasive diagnosis of acute deep vein thrombosis. A comparison between thermography, plethysmography and phlebography. *Acta Med Scand* 1979;206(6):463-6.
26. Aronen HJ, Suoranta HT, Taavitsainen MJ. Thermography in deep venous thrombosis of the leg. *AJR Am J Roentgenol* 1981;137(6):1179-82.
27. Lockner D, Paul C, Hedlund B, Schulman S, Nyman D. Thermography in the diagnosis of DVT. *Thromb Haemost* 1981;46(3):652-4.
28. Pochaczewsky R, Pillari G, Feldman F. Liquid crystal contact thermography of deep venous thrombosis. *AJR Am J Roentgenol* 1982;138(4):717-23.
29. Sandler DA, Martin JF. Liquid crystal thermography as a screening test for deep-vein thrombosis. *Lancet* 1985;1(8430):665-7.
30. Kalodiki E, Marston R, Volteas N, Leon M, Labropoulos N, Fisher CM, *et al*. The combination of liquid crystal thermography and duplex scanning in the diagnosis of deep vein thrombosis. *Eur J Vasc Surg* 1992;6(3):311-6.
31. Ritchie WG, Lapayowker MS, Soulen RL. Thermographic diagnosis of deep venous thrombosis: anatomically based diagnostic criteria. *Radiology* 1979;132(2):321-9.
32. Brockman SK, Vasko JS. The pathologic physiology of phlegmasia cerulea dolens. *Surgery* 1966;59(6):997-1007.
33. Haller JA, Jr., Mays T. Experimental Studies on Iliofemoral Venous Thrombosis. *Am Surg* 1963;29:567-71.
34. Snyder MA, Adams JT, Schwartz SI. Hemodynamics of phlegmasia cerulea dolens. *Surg Gynecol Obstet* 1967;125:342-6.

Chapter 3

Hemodynamic Changes in Chronic Venous Disease

Introduction

Aims of this chapter

Chronic venous disease (CVD) is a term that includes all long term morphological and functional abnormalities of the venous system, manifest either by symptoms or signs indicating a need for investigation and care.

As a result of CVD, hemodynamic disturbances occur which result in inability of pumps and conduits in the venous system to maintain a normal pressure and normal flow towards the heart (see Chapter 1). Hemodynamic disturbances are caused by venous reflux, obstruction, a combination of reflux and obstruction or arterio-venous fistula. Compensatory mechanisms for obstruction are the extent of collateral circulation and ability of the lymphatic system to maintain drainage. The clinical outcome for development of symptoms and signs is a result of the relative contribution from these forces and compensatory mechanisms. Inability to quantitate all these forces and mechanisms in individual patients leads to incomplete understanding of the pathophysiology, and results in controversy and major challenges in the management of CVD.

Chronic venous insufficiency (CVI) is a term reserved for advanced CVD, and is applied to functional abnormalities of the venous system producing edema, skin changes or ulceration (C₃-C₆).

The main aim of this chapter is to summarise known hemodynamic changes that occur in different types of CVD and at the same time indicate areas where there is lack of data. Another aim is to present various hypotheses and theories that are still unproven and which need to be elucidated by further research.

A problem with the literature regarding hemodynamics is that many references are quite old, from the 1980's or even older. The patient selection at that time was made based mainly on phlebographic diagnosis. Duplex was not generally available. We know that the results from these methods may differ, especially regarding judgement regarding incompetent perforating veins. Therefore it is difficult to judge whether the examined cohorts with CVI previously would have shown the same severity and distribution of disease if color duplex ultrasound had been used.

Current thinking on the usefulness of hemodynamic measurements

The authors of many of the studies published in the 1970s and 1980s have spent a lot of time trying to find out if hemodynamic measurements can diagnose the presence of venous abnormalities or discriminate between different clinical severity classes. This approach belongs to the pre-duplex ultrasound era when hemo-

dynamic measurements were used as noninvasive diagnostic tests. Currently, duplex ultrasound provides accurate information about the presence and anatomic extent of reflux or obstruction. Hence, there is no need for hemodynamic measurements to be used as diagnostic tests but instead as measurements that tell us how much reflux and/or how much functional obstruction there is, after the ultrasound examination has been made (For correlation of hemodynamic measurements with clinical severity see Chapter 10).

Pathophysiology of varicose veins and deep venous disease

Varicose veins are a common manifestation of CVD and are believed to result from abnormal distensibility of connective tissue in the vein wall. Veins from patients with varicosities have different elastic properties than those from individuals without varicose veins^{1, 2} There is hypertrophy of the vein wall with increased collagen content,³ fragmentation of elastin fibres⁴ with degradation and accumulation of extracellular matrix.⁵

Primary varicose veins result from venous dilatation and/or valve damage without previous DVT. Secondary varicose veins are the consequence of DVT appearing as collateral vessels or the consequence of valve damage. Recanalization may give rise to relative obstruction and reflux in deep, superficial and perforating veins.⁶

Approximately 30% of patients with deep venous reflux shown by imaging appear to have primary valvular incompetence rather than detectable post-thrombotic damage^{7, 8} Rarely, deep venous reflux is due to valve agenesis or aplasia.⁹ Varicose veins may also be associated with pelvic vein reflux in the absence of incompetence at the saphenofemoral junction (SFJ), thigh or calf perforating veins. Retrograde reflux in ovarian, pelvic, vulvar, pudendal or gluteal veins may be also associated with clinical symptoms and signs of pelvic congestion.¹⁰⁻¹³

Following DVT, spontaneous lysis over days or weeks and recanalization over months or years can be observed in 50% to 80% of patients.¹⁴⁻¹⁶ Rapid thrombus resolution after DVT is associated with a higher incidence of valve competency.^{14, 17} Such rapid resolution depends on thrombus extent, location, local inflammation, potency of local fibrinolytic agents and pro-inflammatory mediators.^{18, 19} Inadequate recanalization following DVT can lead to outflow obstruction. Less

frequently, obstruction results from extramural venous compression (most commonly left common iliac vein compression by the right common iliac artery),^{20, 21} intra-luminal changes²²⁻²⁴ or rarely from congenital agenesis or hypoplasia.²⁵

Most post-thrombotic symptoms result from venous hypertension due to valvular incompetence, outflow obstruction or a combination of both. Venous hypertension increases transmural pressure in post-capillary vessels leading to skin capillary damage with increased microvascular permeability,²⁶ followed by lipodermatosclerosis and, ultimately, ulceration.²⁷ Edema will develop when the increased lymphatic transport fails to adequately compensate for increased fluid filtration into the tissue, and thus venous hypertension is invariably associated with a damaged lymphatic drainage in the skin as well as in the sub fascial space in cases of post-thrombotic syndrome.^{28, 29} The reported prevalence of post-thrombotic syndrome following DVT has been variable (35% to 69% at three years and 49% to 100% at five to 10 years) and depends on the extent and location of thrombosis as well as treatment, but also on definition.³⁰⁻⁴⁰

Patients with both chronic obstruction and reflux have the highest incidence of skin changes or ulceration.³⁰ The risk of ipsilateral post-thrombotic syndrome is higher in patients with recurrent thrombosis and is often associated with congenital or acquired thrombophilia.⁴¹⁻⁴⁴ More recent studies imply that skin changes and/or ulceration are less frequent (4% to 8% in 5 years) in patients with thrombosis proximal to the knee if they have been treated with adequate anticoagulation, early mobilization and long-term compression therapy.^{45, 46}

Mechanical dysfunction of the calf muscle pump may enhance development of leg ulceration suggesting the importance of the range of ankle motion⁴⁷ and patient activity⁴⁸ in relation to progression of disease. Obesity is another risk factor for severe venous disease, probably because of its association with decreased fibrinolytic activity in blood and tissues.⁴⁹

Incompetent perforating veins

Incompetent perforating veins (IPVs) can be defined as those that penetrate the deep fascia and permit deep to superficial flow. The flow in IPVs in the calf is usually bidirectional, outward during muscular contraction and

inward during relaxation. In normal legs and in the majority of patients with primary uncomplicated varicose veins, the net flow is inward from superficial to deep (re-entry perforating veins). This was demonstrated in 1891 by Trendelenburg⁵⁰ and more recently by Bjordal who used electromagnetic flow meters during exercise (see below).⁵¹ The net flow is also inward even in patients with femoral vein reflux, provided the popliteal valves are competent. However, flow is predominantly outward in the presence of popliteal valve incompetence (axial reflux) and especially when there is associated deep vein obstruction.^{51, 52} The IPVs are associated with superficial and/or deep venous reflux but are rarely found in the absence of reflux.⁵³⁻⁵⁵ The prevalence of IPVs, their diameter, volume flow and velocity increase with clinical severity of CVD whether or not there is co-existing deep venous incompetence.^{51, 56-61}

Up to 10% of patients, often women, presenting with clinical C of CEAP 1 to 3 disease have non-saphenous superficial reflux in association with unusually located IPVs.⁶²

Molecular mechanisms affecting the venous wall.

As mentioned above, varicose veins have different elastic properties to normal veins.^{1, 2} The ratio between collagen I and collagen III is altered as are dermal fibroblasts from the same patients suggesting a systemic disorder with a genetic basis.⁶³

Leukocyte activation, adhesion and migration through the endothelium as a result of altered shear stress⁶⁴⁻⁶⁶ contribute to the inflammation and subsequent remodeling of the venous wall and valves.⁶⁷⁻⁷⁰ Reduction in shear stress also stimulates production of transforming growth factor- β 1 (TGF- β 1) by activated endothelial cells and smooth muscle cells (SMCs) inducing SMC migration into the intima and subsequent proliferation as well as phenotype change. Fibroblasts proliferate and synthesize matrix metalloproteinases (MMPs) overcoming the effect of tissue inhibitors of metalloproteinases (TIMPs). The MMP/TIMP imbalance results in degradation of elastin and collagen.^{65, 71, 72} This may contribute to hypertrophic and atrophic venous segments and valve destruction as observed in varicose veins. Remodeling of the venous wall and abnormal venous distension prevents valve leaflets from closing properly resulting in reflux.

Genetic factors may also play a role in progression of primary varicose veins to advanced CVD. A relationship between the C282Y polymorphism in hemochromatosis (HFE gene) and venous ulceration has been described.⁷³

Hemodynamic factors associated with wall remodelling

This section examines the changes in size, shape and composition of a venous conduit in response to hemodynamic forces. Veins are often used as arterial conduits as with in-situ and reversed saphenous bypass grafts, arteriovenous (AV) fistulae for hemodialysis and AV malformations. These veins, though not classified as chronic venous disease, demonstrate the diverse morphological changes that occur in a vein when it is exposed to the sustained high pressure pulsatile environment of oxygenated arterial blood, a remodelling process called arterialization. Shear stress and wall tension are major factors which induce intimal hyperplasia within and at the anastomoses of arterialized vein grafts.^{74, 75} These grafts eventually occlude given sufficient time. The venous outflow tracts of AV malformations behave differently since they dilate rather than occlude, and counter-intuitively this is a process that can be exacerbated in some patients by inflow embolization or ligation. Furthermore, hormonal factors like puberty and pregnancy can be more significant in increasing the size of these lesions than hemodynamic factors.

The relationship between hemodynamic forces and vein morphology is poorly understood. Veins in patients with CVD are exposed to a much wider range of hemodynamic forces than veins used as arterial conduits, resulting in dilatation but rarely occlusion. Venous pressures can range from -5 mmHg to over 200 mmHg during a sudden calf contraction, with velocity ranges considerably wider than the arterial circulation. Furthermore, changes of arterialization resulting in occlusion are rarely seen. This is despite the fact that the hydrostatic pressure in an ankle vein may reach arterial pressure and that saphenous pulsatile flow is usually observed in patients with advanced CVD.⁷⁶

Pressure is considered to be the main precipitating factor for varicose veins. Varicose veins would not occur without hydrostatic pressure from a gravitational force. The effect of dilatation is easily understood from the unrelenting radial forces against the wall of the

vein. This can occur in deep, perforating and superficial veins and plays a major part in the increase in venous volume in patients with CVD. Less clear is why this occurs at the thigh part of the GSV in many patients whilst preserving the ankle part which is the recipient of higher hydrostatic pressure (descending theory). Even less clear is why do superficial veins dilate and become tortuous forming varicose veins whereas the GSV just dilates but rarely becomes tortuous within its intermediate compartment.

Comparisons between normal veins and varicose veins help to delineate normal anatomy from pathological remodelling. Varicose veins demonstrate increased wall thickness as well as increased diameter and length.⁷⁷ As indicated in the introduction, histology using electron microscopy shows that the walls are heterogeneous with atrophic and hyperplastic areas, disorganized elastin patterns and smooth muscle cell microherniations.⁷⁸

Smooth muscle cell cultures reveal that these cells have undergone phenotypic modulation from a contractile to a proliferative and secretory state.⁷⁹ Cell culture and organ stretch models can reproduce these changes with differential gene expression.⁸⁰ Up to 34 differentially expressed genes have been identified in GSVs having reflux, in comparison to normal GSVs, and matrix Gla protein is likely to be the main protein involved in the remodelling process.⁸¹ There is also a clear difference between normal leg veins compared with varicose leg veins which are less elastic and stiffer.⁸² Remodelling depends on the strength of the hemodynamic insult and its effects on the genetic resilience or adaptability of the target vein. Vein wall composition may be more important than hemodynamics in this regard. The relevance of discriminating between normal and varicose veins can be questioned since there is little evidence to refute an hypothesis that extensive varicose veins may delay the onset of skin changes compared to patients with gross saphenous reflux and minor varicose veins.⁸³

Reduction of flow leading to stasis is a major etiological factor for vein thrombosis and also hampers DVT resolution.⁸⁴ Both have a profound impact on vein morphology. The prevalence of DVT in immobile patients supports the reduced flow component of Virchow's triad.⁸⁵ Mural thrombosis induces smooth muscle cell proliferation and this can lead to fibrosis, wall thickening, occlusion, venous adhesions and synechiae, ap-

parent during surgical disobliteration⁸⁶ which become clinically manifest as the post-thrombotic syndrome. Consequently, a cycle of harm is set up causing wall inflammation, thickening, valve destruction and fibrosis, a further reduction in flow and a greater propensity to develop recurrent DVT.

Recirculation is another common hemodynamic phenomenon in CVD. Blood is ejected upwards by calf muscle contraction and then flows outwards and downwards into incompetent saphenous trunks via thigh perforating veins, including the SFJ and sapheno-popliteal junction (SPJ). The re-circulation loop is completed when blood re-enters the deep veins via lower-level perforating veins during calf diastole. Regional recirculation loops may concentrate pro-thrombotic biomarkers,⁸⁷ promote hypoxia and encourage areas of stasis, all resulting in mural thrombosis. This is manifest as superficial vein thrombosis (SVT) or even DVT with consequent vein wall remodelling.

Reduced flow encourages thrombosis which in turn activates endogenous proteases like plasmin and matrix metallo-proteins (MMPs). These have a major role in the resolution of venous thrombosis and therefore post-thrombotic vein wall remodelling. Fibrinolytic strategies which augment the sterile inflammatory process of thrombus resolution,^{88, 89} such as urokinase plasminogen activator together with lack of plasmin activator inhibitor-1, may also have a detrimental effect on the vein wall leading to stiffness and fibrosis.^{90, 91} Similarly, plasmin inhibition may decrease vein wall stiffness but at the expense of larger thrombi.⁹² In an experimental model of IVC ligation in normal rats, it has been shown that early thrombus size is smaller compared with neutropenic rats which have increased vein wall weight, stiffness, thickness and collagen.⁹³

Hypothesis: formation of varicose veins by IPV reflux jets

There is much speculation about the forces that contribute to vascular remodeling. As indicated above, factors include luminal wall shear rates, viability of the vasa-vasorum and excess intraluminal pressure. The use of the GSV as an arterial conduit in situ is a direct test disproving the effect of elevated luminal pressure while the use of reverse saphenous vein grafts which strips the vasa-vasorum supply is a test of wall ischemia resulting

from vasa-vasorum dysfunction. There is a hypothesis that could explain several aspects of vascular remodeling. If the vascular intima contains an expansion inhibitor that can be removed by excessive convection (high shear rate = high momentum transfer ~ high mass transfer) such as velocity jets impinging on the vascular wall, then much of the clinically observed vascular remodeling would result. With removal of the inhibitor, the local area of vascular wall would expand.

When flow rate through a conduit is increased beyond the turbulent limit (Reynolds number > 2500), laminar flow transitions into turbulent flow (Figure. 3.1, upper center) resulting in a high pressure gradient, bruit/murmur/thrill, spectral broadening on ultrasound and eventually diametric expansion which continues until laminar flow is restored.

$$Re = 4 Q \rho / \pi D \mu$$

This diametric expansion is consistent with the speculation of a removable wall expansion inhibitor.

At the carotid bifurcation, the dilation known as the carotid bulb is positioned on the wall opposite to the axis of the external carotid branch (Figure. 3.1, upper left). If the angle between the CCA/ICA axis and the external carotid is large, then the bulb is distal to the ICA/ECA flow divider, if the ECA angle is small, then the bulb is proximal to the divider. This implies that the early diastolic flow reversal in the external carotid (enhanced by facial vascular constriction) provides a reverse jet that washes expansion inhibitor from the opposite wall until the wall expands sufficiently to diminish the elevated shear rate there. Distal to an arterial stenosis (Figure. 3.1, upper right), post-stenotic turbulence is associated with post-stenotic dilation for a similar reason.

If this hypothesis is correct, then aneurysmal arteries and veins (varicosities) might result from the same mechanism. In abdominal aortic aneurysm, atherosclerosis at the origins of the lumbar arteries during diastolic reversal (which is time displaced from iliac reversal) could form jets that cross the (20 mm to 50 mm) width of the aortic lumen to impinge on the opposite wall causing dilation (Figure 3.1, lower left). Similarly, IPVs draining superficial leg veins would form jets during compartmental compression, increasing the diameter and length of these veins resulting in varicosities. Of course, the stabilizing effects of arterial flow in the

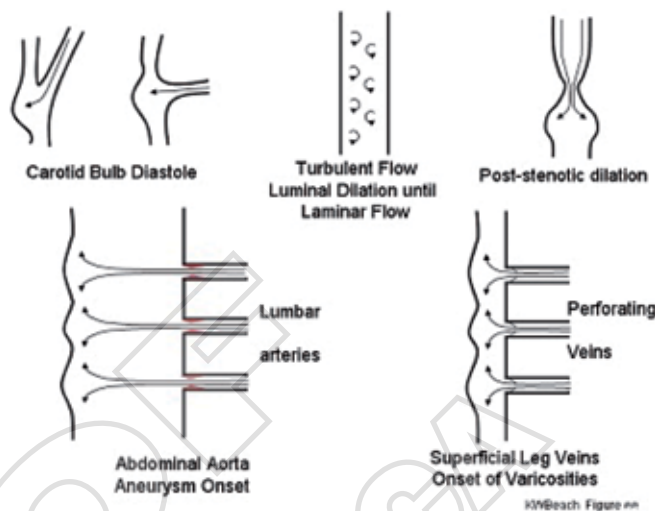

Figure 3.1.—Hypothetical Mechanism of Vascular Remodeling

aorta minimize aortic elongation, but the elongation of the superficial leg veins is not similarly diminished.

The validity of this speculation requires attempts at experimental refutation by a combination of computational tests and ambulatory experimental methods.

The magnitude of hemodynamic changes in different forms of CVD.

Pressure changes in limbs with varicose veins or deep venous reflux

As indicated in Chapter 2, when a person stands still supported on a walking frame in order to avoid any muscular activity, the pressure in veins of the foot or at the ankle is the result of the height of the column of blood extending to the level of the heart. In the presence of varicose veins or even deep venous reflux, the resting pressure is the same as in normal legs. However, muscular contractions of the calf during tiptoeing or walking produce changes that are different from normal limbs.

The earliest measurements of venous pressure in the dorsum of the foot during exercise were made by Pollock and colleagues in 1949.^{94, 95} Measurements were made during standing and walking on a treadmill at 1.7 miles per hour after inserting a needle in a vein at the ankle. In normal limbs during exercise, the pressure decreased from an average of 87 mmHg (range 79-92) to 22 mmHg (range 11-31). In limbs with varicose veins, it decreased from an average of 81 mmHg to 44 mmHg

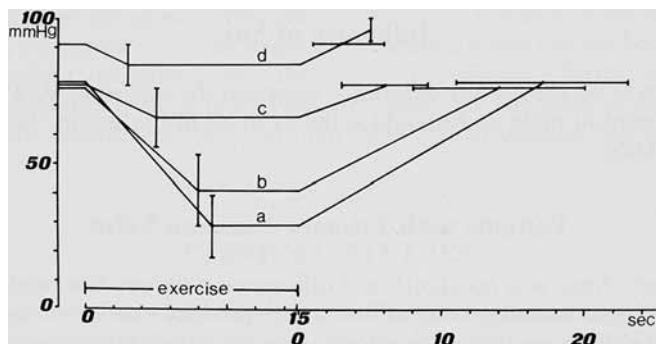

Figure 3.2.— Changes of mean venous pressure during exercise by means of standing on tiptoe 10 times in healthy volunteers (a), patients with primary varicose veins without (b) and with (c) IPVs, and in patients with the post-thrombotic syndrome (d). Mean values and standard deviation of lowest pressure and recovery time are shown.

(range 34-51). At the end of exercise the pressure returned to the resting level (recovery or refilling time-RT) on average at 31 seconds in normal limbs and 2.8 seconds (range 1.2-5.5) in patients with great saphenous reflux. The prolonged RT at the end of exercise seen in normal limbs is an indication that there is no reflux and that the veins refill via the microcirculation. The more severe the reflux, the shorter is the RT. Simultaneous measurement of RT using venous pressure and photo-plethysmography (PPG) has demonstrated a high degree of linear correlation in two studies ($r=0.93$ and $r=0.88$).^{96, 97} These observations led to the development of the noninvasive method of measuring RT.

Several subsequent studies with a needle inserted in a vein on the dorsum of the foot have confirmed the above initial results.⁹⁸⁻¹⁰² and the exercise test was standardized to 10 knee bends⁹⁹ or 10 tiptoe movements¹⁰² at the rate of one per second (Figure 3.2). The AVP was defined as the lowest pressure reached during exercise. Some investigators repeated the exercise after inflating a 2.5 cm wide pneumatic cuff at the ankle (Figure 3.3). By applying the cuff at higher anatomical levels (upper thigh, lower thigh and just below the knee) and repeating the exercise, sites of deep to superficial reflux could be determined.¹⁰² Soon it became obvious that in the presence of axial deep vein reflux, a cuff at the ankle or combination of cuffs could not normalize the AVP. The highest AVP was found in the presence of both deep axial reflux and obstruction (Table 3.1). In some patients with severe outflow obstruction who presented with venous claudication, there was actually an increase in AVP to 120-130 mmHg.

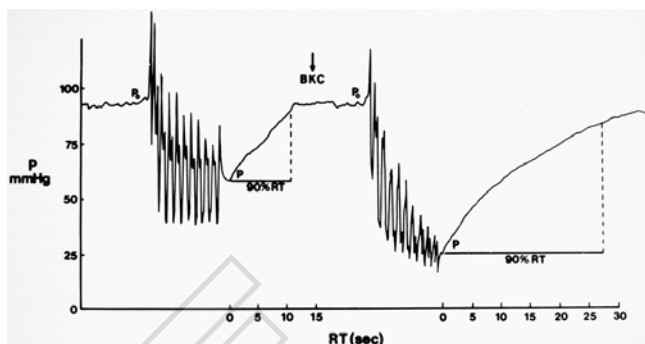

Figure 3.3.—Recording of ambulatory venous pressure (AVP) at rest and during 10 tiptoe movements. The first recording was without and the second with a below knee cuff which occluded the great and small saphenous veins. Normalization of the AVP (P) and the refilling time (90% RT) indicate normal deep veins, reflux confined to the superficial veins and absence of calf IPVs.¹⁰⁷

An attempt to standardize the method of AVP measurement by a group of experts resulted in the “Expert consensus document on direct ambulatory venous pressure measurement” published in 2013.¹⁰³ It was recommended that AVP measurement should be performed on a treadmill at 2 km/h and an elevation of 8°. Tiptoe or knee bending may be used if a treadmill is not available. The AVP was defined as the mean AVP (see pressure at the end of exercise and at the beginning of the refilling curve in Figure. 3.3) or [systolic venous pressure + (2 x diastolic venous pressure)]/3. Refill time (RT) should not be routinely used as an outcome measure. Mean AVP in the range of 10-30 mmHg is considered normal, 31-45 mmHg as intermediate venous hypertension and > 45 severe venous hypertension.

Reduction in the venous pressure at the ankle during walking by interrupting reflux in the superficial varicose veins by finger compression or by applying a tourniquet dates back to the studies of Warren *et al.*¹⁰⁴ in 1949, confirmed subsequently by Ludbrook in 1963¹⁰⁵ and Kuiper in 1966.¹⁰⁶ They claimed that application of tourniquets at different levels on the leg allowed them to determine the levels of deep to superficial reflux and hemodynamic significance of IPVs (see below).

Arnoldi recorded pressures in the posterior tibial veins and GSVs simultaneously at rest and during calf muscle contraction in a series of patients with varicose veins and IPVs on the medial aspect of the leg above the ankle.^{108, 109} During standing at rest, the average pressure was 78 in the GSV and 76 mmHg in the posterior tibial vein. During calf muscle contraction, pressures

TABLE 3.1.—Values of ambulatory venous pressure (AVP) (95% range) in mmHg, in different limbs.

Type of pathology	No ankle cuff	Ankle cuff inflated
Normal	15-30	15-30
Varicose veins and competent perforating veins	25-40	15-30
Varicose veins and incompetent perforating veins	40-70	25-60
Deep axial reflux and proximal occlusion	55-85	50-80

increased to 101 mmHg and 118 mmHg respectively indicating a change of the superficial to deep gradient of 2 mmHg to a reversed gradient of 15 mmHg from deep to superficial. During muscle relaxation the pressure decreased to 30 mmHg in the posterior tibial veins and to 43 mmHg in the great saphenous indicating another reversal of the pressure gradient from superficial to deep.

As shown in Table 3.1, if there is reflux in the deep veins then AVP is higher than in patients with varicose veins and a normal deep venous system. The highest AVPs are found in patients with both axial deep venous reflux and obstruction (Figure 3.2).

An understanding of the mechanism that produces these pressure changes has been derived from a mathematical hemodynamic model.¹¹⁰ It was observed that in the absence of obstruction, the pressure reduction fraction per step (one tiptoe per second) was constant for the first 4-6 steps until a steady state was established. The pressure reduction fraction which is a function of the efficacy of the calf muscle pump was the same in normal limbs, limbs with varicose veins and limbs with axial deep venous reflux. However, the refilling rate was different in each group. In normal limbs, the slow refilling rate (slow increase in pressure) during relaxation time between the steps meant that there was minimal increase in pressure before the next step, this increase in pressure between steps was higher in limbs with varicose veins and highest in limbs with axial deep reflux. In each group, the steady state was reached when the volume expelled per step was equal to the amount of reflux per second. Thus, the steady state was reached at a pressure of 22 mmHg in normal limbs, 42 mmHg in limbs with varicose veins and 72 mmHg in limbs with deep axial reflux.

Extent of reflux on descending phlebography and AVP

The hemodynamic significance of various degrees of reflux as demonstrated by descending phlebography

was compared with AVP measurements in 32 patients (45 affected limbs) with active or healed venous ulceration.¹¹¹ Reflux was graded using Herman’s classification:¹¹² **Grade 0:** no reflux below the confluence of the femoral and deep femoral veins, i.e. the uppermost valve of the femoral vein. **Grade 1:** reflux beyond the uppermost valve of the femoral vein but not below the middle of the thigh. **Grade 2:** reflux into the femoral vein to the level of the knee with popliteal valves competent. **Grade 3:** reflux to a level just below the knee with incompetent popliteal valves but competent valves in the axial calf veins. **Grade 4:** reflux through the axial veins (femoral, popliteal and calf veins) to the level of the ankle.

The AVP and refilling time 90 (RT90) were recorded in all patients. In addition, the presence of deep to superficial reflux into the GSV at the SFJ, thigh IPVs, small saphenous vein at the SPJ and calf IPVs was recorded using ascending functional phlebography.

The examined limbs were separated into two groups according to the grade of reflux. Group I consisted of limbs in which popliteal valve incompetence was not demonstrated on descending phlebography i.e. grades 0-2 (18 limbs). Group II consisted of limbs with popliteal reflux as demonstrated by descending venography i.e. grades 3 and 4 (27 limbs).

In Group I the mean AVP ± sd was 47.2 ± 9.3 mmHg (range 31-67 mmHg). After the application of an ankle tourniquet to exclude the effects of superficial venous incompetence on the pressure recordings, the mean AVP ± sd became 28.1 ± 9.9 mmHg (range 11-44) (paired t test: P < 0.001).

In Group II (limbs with incompetent popliteal valves) the mean AVP ± sd was 71.6 ± 12.7 mmHg (range 49-95 mmHg) before the tourniquet. This was significantly higher than in Group I (t test: P < 0.001). The application of the ankle tourniquet in this group produced a small but significant decrease in the AVP (mean AVP ± sd: 66.0 ± 14.5 mmHg) (paired t test: P < 0.001) (Figure. 3.4).

These findings indicate that incompetent femoral valves in the presence of competent popliteal valves add very little to the hemodynamic abnormality produced by superficial venous reflux. In the majority of these patients, there is co-existing reflux from deep to superficial veins with associated superficial valve incompetence which is responsible for the venous hypertension,

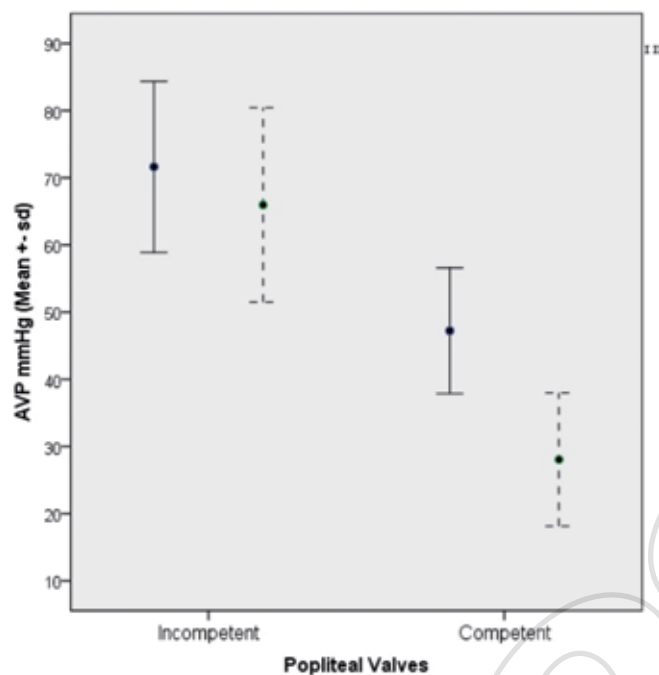

Figure 3.4.—Ambulatory venous pressure in the presence of incompetent and competent popliteal valves (Continuous lines are without and dotted lines with an ankle tourniquet).

skin changes and ulceration. The hemodynamic changes which in the past had been associated with deep venous insufficiency (AVP > 45 mmHg and RT90 < 14 seconds despite the application of an ankle tourniquet) occur only when there is popliteal incompetence.

Effect of ligation of an incompetent saphenofemoral junction on AVP

In patients with a normal deep system, Bjordal^{51, 113} demonstrated that proximal compression of the saphenous vein reduced AVP even in the presence of calf IPVs. Ligation of the SFJ and excision of varices was shown to increase the fall in pressure during exercise from 25±17 mmHg before operation to 40±15 mmHg after operation (P=0.001).¹¹⁴

Hemodynamic assessment of incompetent calf perforating veins

As stated above, flow in calf IPVs is in both directions, outward during calf muscle contraction and inward during relaxation. In patients with primary un-

complicated varicose veins, the net flow is inward from superficial to deep. In the presence of severe damage to the deep veins, the flow is predominantly outward.¹¹³

In the 1970s and 1980s, several workers tried to determine the importance of IPVs in association with varicose veins, skin changes and venous ulceration. Although the adverse effect of IPVs in limbs with reflux and/or obstruction of the deep venous system became well established¹¹⁵⁻¹¹⁹ the finding of calf IPVs in the presence of patent deep veins with competent valves was of unknown hemodynamic significance.^{117, 120, 121} One major difficulty in assessing the hemodynamic function of IPVs is the fact that reflux in superficial veins is always a confounding variable, both for pre-interventional testing and for postoperative evaluation.

The AVP measurements and foot volumetry without and with digital occlusion of IPVs or by studying patients before and after surgical ligation have indicated that in primary uncomplicated varicose veins, IPVs do not have any adverse effect on calf muscle pump function. They are now considered to be re-entry points. However, in the presence of skin changes (edema, fibrosis, hyperpigmentation, ulceration) occlusion or ligation of IPVs was found to improve hemodynamics.^{122, 123} With the advent of duplex ultrasound scanning, color flow imaging suggested that the extent of the valvular damage in tibial veins determined the amount of blood that leaks outwards through IPVs and hence their hemodynamic significance.¹²⁴

The hemodynamic significance of calf IPVs was assessed by measuring the AVP and venous pressure refilling time (90% RT) (Figure 3.2) without and with a tourniquet at the ankle or just below the knee.⁵⁸ This study involved 70 limbs which fulfilled the following criteria: IPVs in the calf were demonstrated on venography, the deep veins were patent, popliteal vein valves were competent but segmental reflux was either absent or present in variable lengths in the tibial veins. On the basis of the AVP and 90% RT, it was possible to classify IPVs into three groups of different hemodynamic significance: Groups I, II and III. All three groups had a 90% RT less than 15 seconds and AVP greater than 45 mmHg before application of any tourniquets. **In Group I** (20 limbs), application of a below knee tourniquet, resulted in both AVP and 90% RT becoming normal (P < 45 mmHg and 90% RT > 15 seconds) (Figure. 3.5). These limbs behaved like the limbs with primary vari-

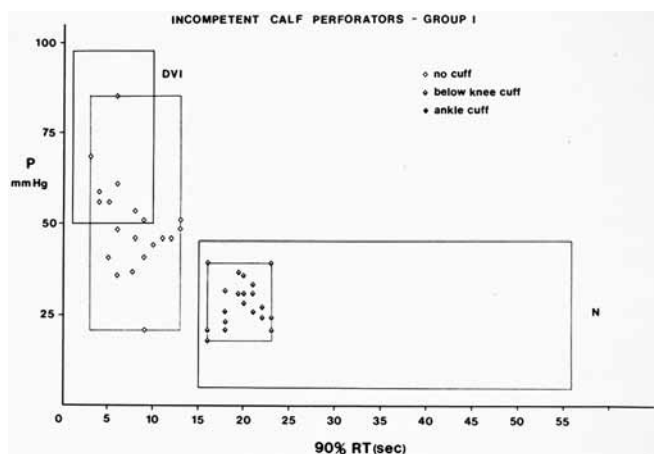

Figure 3.5.—Plot of AVP (P) against 90%RT. Rectangle DVI marks the range of AVP and 90%RT of limbs with deep venous valvular incompetence. Rectangle N marks the range of AVP and 90%RT of limbs with normal venous system (from previous studies). Diamonds represent individual results of limbs with calf IPVs of no hemodynamic significance (Group I). There was no need to apply an ankle cuff since normalisation of the results was achieved with a below knee cuff.

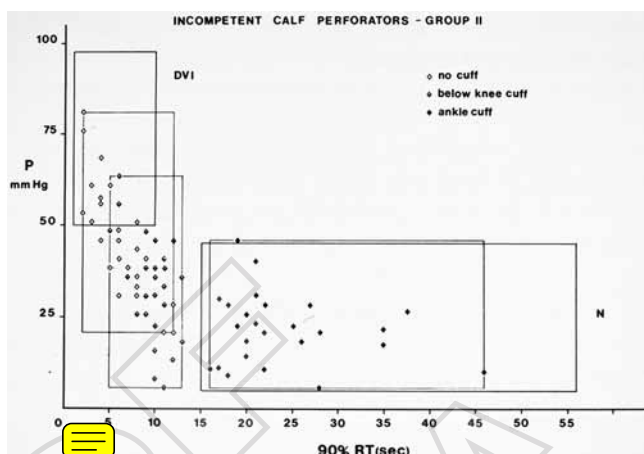

Figure 3.6.—Plot of AVP (P) against 90%RT. Rectangle DVI marks the range of AVP and 90%RT of limbs with deep venous valvular incompetence. Rectangle N marks the range of AVP and 90%RT of limbs with normal venous system (from previous studies). Diamonds represent individual results of limbs with calf IPVs of moderate hemodynamic significance (Group II).

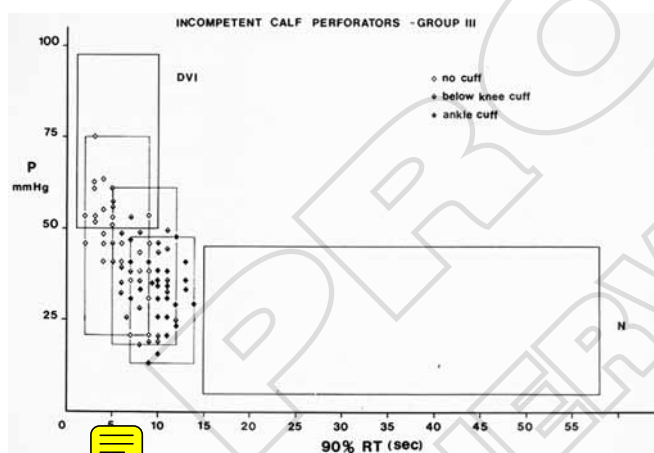

Figure 3.7.—Plot of AVP (P) against 90%RT. Rectangle DVI marks the range of AVP and 90%RT of limbs with deep venous valvular incompetence. Rectangle N marks the range of AVP and 90%RT of limbs with normal venous system (from previous studies). Diamonds represent individual results of limbs with calf IPVs of severe hemodynamic significance (Group III).

cose veins without IPVs. Thus, the IPVs in the limbs of group I demonstrated on venography could be considered to be of no hemodynamic significance.

In Group II (25 limbs), AVP and 90% RT did not become normal following application of a below knee tourniquet but became normal (i.e. > 15 sec and < 45 mmHg respectively) with an ankle tourniquet (Figure.

TABLE 3.2.—Incidence of skin changes and ulceration.

Group	Number of limbs	Skin changes*	Ulceration
I	20	0	0
II	25	17 (68%)	0
III	25	25 (100%)	17 (68%)

(* skin changes = "eczema", pigmentation and lipodermatosclerosis)

3.6). IPVs in these limbs were considered to be of moderate hemodynamic significance.

In Group III (25 limbs), AVP and 90% RT did not become normal after application of a below knee tourniquet and although an ankle tourniquet reduced AVP to 45 mmHg or less, the 90% RT remained abnormal (> 15 seconds) (Figure. 3.7). In view of the short 90% RT despite an ankle tourniquet, these IPVs were considered to be of severe hemodynamic significance.

The incidence of skin changes and/or ulceration in each of the three groups is shown in Table 3.2. There was a high prevalence of pigmentation with lipodermatosclerosis in groups II and III and of ulceration in group III. In fact, apart from the absence of edema, limbs in Group III were clinically indistinguishable from post-thrombotic limbs.

The above study demonstrated that some IPVs contribute significantly to abnormal venous hemodynamics by producing a short refilling time (90% RT). The IPVs

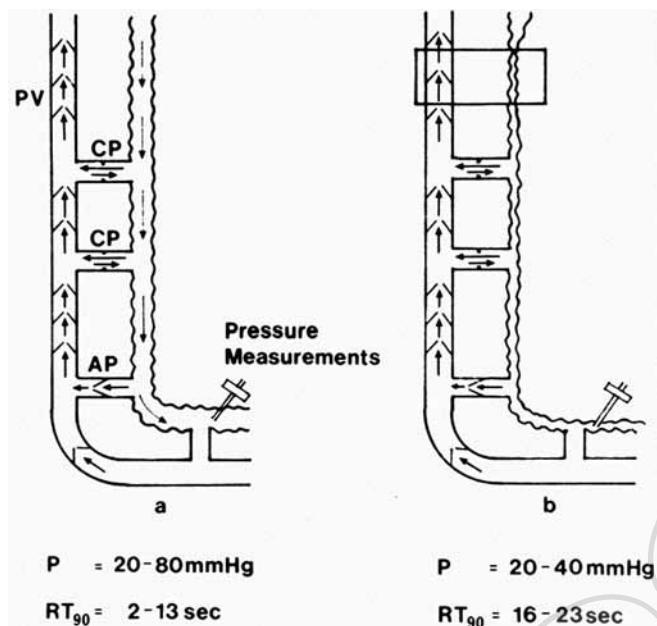

Figure 3.8.—The anatomic abnormality of limbs with Group I IPVs and the effect of the below knee tourniquet.⁵⁸

of groups II and III produce short refilling time during calf muscle relaxation that would produce a high mean AVP throughout the day. This is because when walking at a slow pace (say 1-2 km/hour), the venous pressure will reach a high level before the next step i.e. the next calf muscle contraction.

On the basis of the above findings and observations with duplex ultrasound color flow imaging of tibial veins, the following working hypothesis has been proposed in an attempt to produce a mechanistic explanation for the hemodynamic observations.⁵⁸

The abnormality in the limbs of **Group I** is as follows. The **IPVs are associated with competent valves in the tibial veins**. Flow in superficial veins is downward with outward flow in IPVs during calf muscle contraction and inward flow during relaxation (Figure 3.8). Because valves in the deep veins are competent, outward flow in IPVs is minimal and thus the net flow is inwards. The AVP (P) is in the range of 20-80 mmHg (Figure 3.5) and RT₉₀ is 2-13 seconds depending upon the amount of reflux in the superficial veins of the great and small saphenous systems. Application of a below knee tourniquet (Figure 3.8b) will abolish reflux in the superficial system whose veins will collapse normalising AVP and RT₉₀.

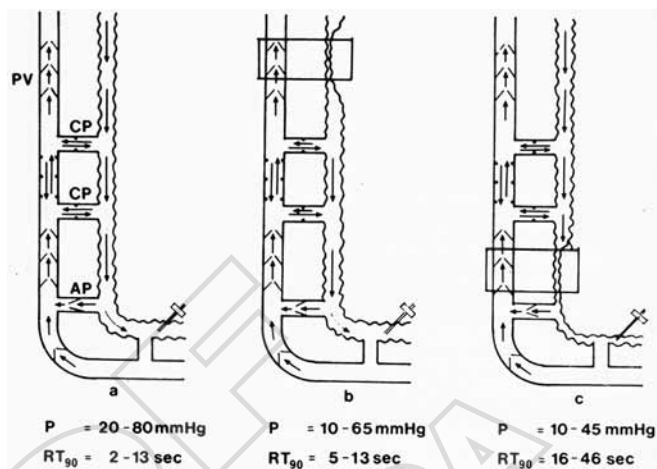

Figure 3.9.—The anatomic abnormality of limbs with **Group II** ICP and the effect of the below knee and ankle tourniquets.⁵⁸

The abnormality in limbs of **Group II** is as follows. The **IPVs are associated with a considerable number of incompetent valves in deep veins above and below their junction with the IPVs** (Figure 3.9), but with competent deep valves in the lower part of the leg at and just proximal to the ankle. In these limbs, a considerable amount of blood leaks from deep to superficial veins through the IPVs. Application of a below knee tourniquet (Figure 3.9b) will abolish reflux in superficial veins but not that leaking out through IPVs. The AVP (P) and RT₉₀ (Figure 3.9b) are reduced but not normalised. However, application of an ankle tourniquet (Figure 3.9c) prevents any deep to superficial reflux through IPVs or reflux down superficial veins to reach the foot. The veins of the foot collapse, with normalisation of the AVP and RT₉₀.

The abnormality in limbs of **Group III** is more severe. **All valves in the deep veins distal to the popliteal vein are incompetent including those at the ankle**. There is a large amount of blood refluxing from deep to superficial veins through a large number of IPVs including those at the ankle (Figure 3.10). Application of a below knee tourniquet abolishes downward flow in superficial veins but not the outward leaking through the IPVs (Figure 3.10b). The AVP (P) and RT₉₀ are only moderately reduced (AVP more than RT₉₀) depending on the volume ejected by the calf muscle pump through the competent popliteal valves (Figure 3.10). Application of an ankle tourniquet abolishes reflux at the foot via superficial veins but not through the deep veins

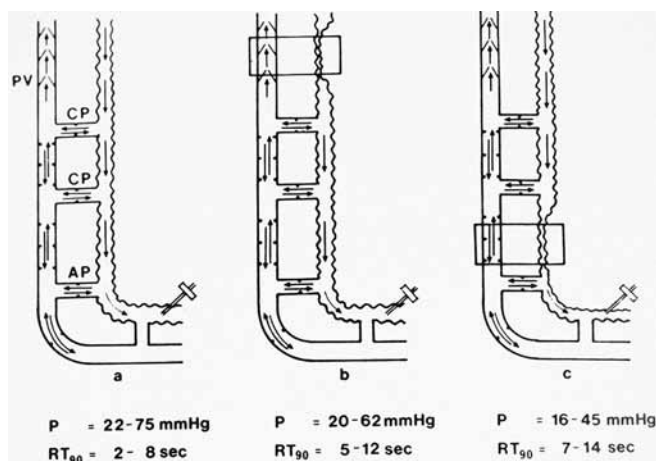

Figure 3.10.—The anatomic abnormality of limbs with **Group III ICP** and the effect of the below knee and ankle tourniquets.⁵⁸

which are filled though the lowest ankle IPV's (Figure 3.10c). The AVP normalises (<45 mmHg) during exercise because outflow from the foot markedly exceeds inflow (reflux). However, in view of the reflux along the pathway shown in Figure 3.10c the refilling time RT90 remains short at the end of the exercise.

Another study involving 132 limbs (16-C₁; 30 C₂; 20-C₃; 25-C₄; 21 C₅ and 20-C₆) studied with both duplex ultrasound and air plethysmography demonstrated that reflux (VFI) increased with increasing number of perforating veins (Figure 3.11),¹²⁵ whereas EF and RVF did not change with increasing number of perforating veins.

In addition to VFI, venous volume (VV) was also found to correlate with the diameter of the largest IPV's in a study of 36 patients with CVD.¹²⁶ Twenty-six patients with VVs in the normal range (80-170 ml) had a median perforating vein diameter of 3.5 mm (IQR 3.2-4.3). Ten patients with VV greater than 170 ml had a median perforating vein diameter of 5.5 mm (IQR 4.6-7.7) (p = 0.001; Mann-Whitney). There was a linear relationship between the VV and diameter of the largest IPV (r = 0.69, p = 0.01).

Current thinking on incompetent perforating veins in patients with primary varicose veins

Most phlebologists now consider that thigh and calf perforating veins have a different hemodynamic behaviour. Thigh perforating veins are connected with the higher pole of the ambulatory pressure gradient; they

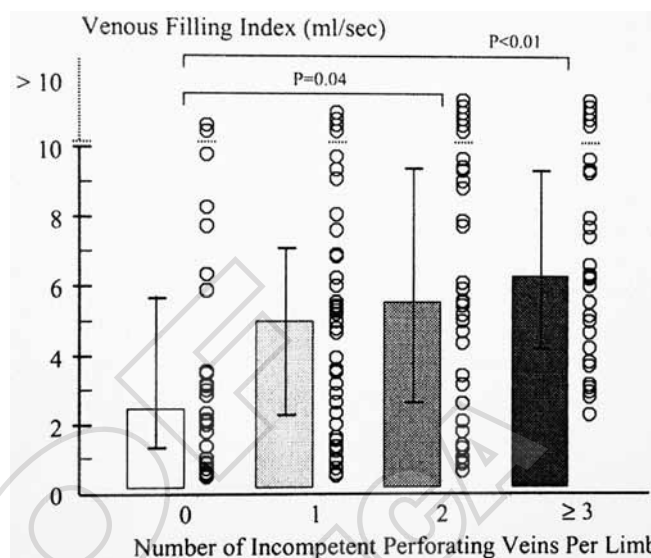

Figure 3.11.—Venous filling index (VFI), presented as median and interquartile range (left) and scattergram (right), in 30 limbs without IPV's, in 40 limbs with one IPV, in 33 limbs with 2 IPV's and 29 limbs with 3 or more IPV's (Mann-Whitney test with Bonferroni correction). The VFI increased with the number of IPV's (p < 0.01 for trend, Kruskal-Wallis).

become the source of reflux if incompetent, and represent a pathological condition. In contrast to that, calf perforating veins are connected with the lower pole of the ambulatory pressure gradient and in the presence of normal deep veins IPV's are unlikely to be the source of the pathological refluxing flow, even if enlarged. They cater for quick pressure equalization between deep and superficial veins at the end of exercise. In primary varicose veins saphenous reflux determines the size of calf perforating veins. The greater the intensity of saphenous reflux, the larger the size of calf perforating veins, and the more pronounced the clinical severity is.

Blood flow in varicose veins

The effect of pressure gradients and changes in pressure gradients induced by exercise on blood flow and flow direction was first elucidated by simultaneous measurement of pressures and flows with electromagnetic flow meters applied on incompetent GSV and perforating veins by Bjordal in 10 patients.^{51, 113} Bjordal could not detect any flow in the GSV when patients were standing still. We now know that the very slow velocity proximally present in this position is below the threshold of the electromagnetic flow meter. Calf

muscle contraction produced an increased pressure in the GSV at the ankle and an upward flow. Lifting the foot off the ground and muscle relaxation was associated with the lowest venous pressure at the ankle and a downward flow which was in the range of 175-500 ml/min (mean 280 ml/min). By placing the electromagnetic flow meter coil detector round the IPVs, Bjordal found that flow was outward when the calf muscles contract and inward during calf muscle relaxation. This bidirectional flow was in accord with the pressure gradients between the posterior tibial veins and GSV found by Arnoldi (see above).¹⁰⁹

The concept of retrograde flow in the GSV and the presence of a “private recirculation” was first demonstrated by Trendelenburg in 1891⁵⁰ by placing a tourniquet at mid-thigh and asking the patient to tiptoe repeatedly when it was observed that veins emptied with refilling from above when the tourniquet was released. We now know that the circuit consists usually of a reflux source feeding a saphenous trunk, conduction of reflux, down towards the foot, and re-entry points back into deep veins via perforating veins. The presence of this phenomenon has been proved using 2-simultaneous duplex probes, above and below the knee.¹²⁷ In this study, reflux was demonstrated to start and stop simultaneously, even when the probes were swapped around. In another study, volume displacements in patients were quantified within saphenous trunks using duplex ultrasound in response to calf compression.¹²⁸ Although reflux volumes correlated with antegrade volumes, they were consistently greater, thereby supporting the recirculation theory.

The findings of bidirectional flow in the GSV and perforating veins by Bjordal^{129, 130} were confirmed in the same year by Folse¹³¹ who used the CW Doppler which had just become available and by duplex ultrasound scanning in later years. The conclusion was that in the presence of competent deep veins, despite inward and outward flow in perforating veins during walking the net effect is inwards. However, when deep venous valves were incompetent and valves in the GSV were competent, Bjordal found that calf contraction caused upward flow in the saphenous vein and that in limbs with both deep and superficial venous reflux, walking produced bidirectional flow in IPVs with the net effect being outwards.

It is now realised that in the majority of patients, the

origin of the downward flow in the superficial system of veins is through the SFJ, thigh IPVs, the SPJ or a combination of two or even all three, and that calf IPVs are re-entry points. This is the basic rationale for the CHIVA technique (see Chapter 8). However, two RCTs have shown that following ablation of superficial incompetence, only 35-40% of IPVs become normal and that new IPVs appear over time.^{132, 133} Further, some 6-8% of ulcer patients show only isolated IPVs as a possible cause for their ulcers.¹³⁴

Duplex ultrasound hemodynamic parameters

Apart from direction of flow, four hemodynamic parameters can be quantitated using duplex ultrasound, namely refilling time, velocity at peak reflux, vein diameter and volume flow.

Reflux

Reflux is a major patho-physiological abnormality in CVD and is probably the most investigated parameter from duplex ultrasound. The cut-off point for the diagnosis of pathological reflux for superficial and deep veins is acknowledged to be 0.5 and 1.0 seconds, respectively.^{135, 136} This is the time required by the initial reflux of blood to bring normal valve leaflets into apposition.

A study of 244 limbs with reflux in 182 patients who had ultrasound scanning, venous pressure measurements, air-plethysmography (APG) and clinical classification according to clinical CEAP classification demonstrated an increase in peak reflux velocity (PRV), time of average rate of Reflux velocity (TAV) and absolute displaced volume (ADV) in C₄₋₆ compared with C₁₋₃, but reflux time (RT) was not significantly different between these groups.¹³⁷ There was no significant correlation between RT, PRV, TAR and ADV *versus* clinical severity in limbs with great saphenous reflux only. However, limbs with axial deep reflux to below the knee with or without concomitant reflux at the knee level had a significant but low correlation between PRV and TAR and clinical severity ($r=0.32$, $P=0.003$ and $r=0.22$, $P=0.049$, respectively). The authors concluded that RT cannot quantify severity of reflux and is a purely qualitative measurement.

Quantification of venous reflux was attempted by

Yamaki *et al.*¹³⁸ who stratified 1,132 limbs in 914 patients with primary valvular incompetence into C₁₋₃ and C₄₋₆. The mean \pm SD reflux time (RT), peak reflux velocity (PRV) and peak reflux flow (PRF) at the SFJ in C₁₋₃ versus C₄₋₆ were 4.05 ± 2.42 versus 3.42 ± 1.87 sec ($P=0.532$), 27.4 ± 21.1 versus 49.7 ± 35.3 cm/s ($P<0.0001$) and 26.3 ± 35.6 versus 64.7 ± 73.4 mL/s ($P<0.0001$), respectively. The corresponding results at the SPJ were 4.55 ± 2.45 versus 3.73 ± 1.92 sec ($P=0.213$), 30.5 ± 16.8 versus 39.5 ± 24 cm/s ($P=0.0002$) and 16.5 ± 15.2 versus 22.2 ± 23 mL/s ($P=0.0029$), respectively. Although their data demonstrated considerable overlap, they concluded that the PRV and PRF improved the discrimination power between early and advanced CVI but that RT was unable to achieve this result. A similar study by the same group used the same parameters in 686 limbs but included patients with secondary as well as primary CVI.¹³⁹ In secondary CVI, they showed that the mean \pm SD PRV had significant discrimination power between C₁₋₃ versus C₄₋₆ at the femoral vein (14.8 ± 10.1 versus 32.4 ± 16.1 cm/s, $P=0.017$) and popliteal vein (18.0 ± 11.2 versus 28.9 ± 19.0 cm/s, $P=0.0003$). The same was true for the PRF at the common femoral vein (34.5 ± 4.2 versus 66.0 ± 19.1 mL/s, $P=0.011$), femoral vein (21.3 ± 34.3 versus 43.8 ± 43.2 mL/s, $P=0.027$) and popliteal vein (15.0 ± 14.6 versus 20.1 ± 16.9 mL/s, $P=0.016$). Once again the overlap in both the PRV and PRF was considerable between the two groups and there was also no significant difference in RT.

Flow volume at peak reflux in ml/sec was measured using duplex ultrasound in the great and small saphenous veins and deep veins in 46 patients (47 legs) with symptomatic varicose veins.¹⁴⁰ Skin changes were present in 19 legs. Total reflux greater than 10 ml/sec was associated with a high prevalence of skin changes (66%) irrespective of whether this was in the superficial or deep veins, whereas reflux less than 10 ml/sec was not associated with skin changes.

Pulsatile flow

The presence of pulsatile saphenous flow using B-flow ultrasound has been shown by one group to be more helpful than the presence of reflux in discriminating severe disease.⁷⁶ The most likely explanation for this pulsatile flow which is often seen in patients with

TABLE 3.3.—Venous hemodynamics across the C of CEAP classes (median and interquartile range).

Variable	Control C ₀ (n=27)	C ₁ (n=26)	C ₂₋₃ (n=24)	C ₄₋₆ (n=35)
VV ml	78 (63.2-93.5)	109 (82-130)	132 (115-140)	149 (125-182)
VFI ml/sec	0.5 (0.3-0.8)	1.3 (0.7-1.8)	3.1 (2.8-4.5)	6.5 (4.0-10.1)
RVF %	15.8 (11.2-23.5)	19.7 (11.7-28.3)	23.5 (20.2-32.3)	40.0 (33.8-46.2)

All values increased significantly ($P < 0.001$, Kruskal-Wallis test).

severe CVD when examined in the standing position is that there is maximum dilatation in arterioles allowing *vis a tergo* to manifest itself through to the venous circulation. This is not the same as pulsatile flow as a result of pressure waves transmitted from the heart, a result of right heart failure and/or tricuspid incompetence.

Vein diameter

The clinical significance of the GSV diameter in the thigh and calf as a marker of global hemodynamic impairment was investigated in a study involving 112 lower limbs (85 patients) with SFJ incompetence and GSV trunk reflux.¹⁴¹ The GSV diameter increased with the C of CEAP classes ($p < 0.001$). Patients were subdivided into four groups: control group (C₀), group 1 (C₁), group 2 (C₂₋₃), group 3 (C₄₋₆). The VFI, VV and RVF increased significantly from C₀ to CEAP₄₋₆ (Table 3.3). The GSV diameter at all limb levels correlated well with VV, VFI, RVF and C of CEAP ($P < 0.009$ for all). A GSV diameter of 5.5 mm or less predicted absent reflux with a sensitivity of 78% and specificity of 87%. A GSV diameter of 7.3 mm or greater predicted critical reflux (VFI > 7 ml/sec) with an 80% sensitivity, 85% specificity and 84% overall accuracy.

Vein diameters were correlated with reflux in a study involving 32 legs.¹⁴² Sixteen had venous ulceration, six skin changes and 10 had symptoms of varicose veins without any skin changes.

All limbs were studied with duplex ultrasound and APG. The VFI had a significant but weak linear relationship ($r = 0.39$) with the diameter of refluxing veins at the knee and a stronger relationship ($r = 0.55$) with the diameter of lower leg veins. The VV correlated well with calf vein diameter ($r = 0.75$).

In a detailed study of 182 legs, measurement of GSV diameter at the proximal thigh 15 cm distal to the groin

(PT) compared to measurement at the SFJ demonstrated higher accuracy and both higher sensitivity and specificity for venous disease class (C of CEAP) as well as for prediction of reflux.¹⁴³ Of 182 legs, 60 had no GSV reflux (controls; group I), 51 had above-knee GSV reflux only (group II) and 71 had GSV reflux above and below knee (group III). The GSV diameters in group I

Measured 7.5 mm at the SFJ and 3.7 mm at the proximal thigh. In groups II and III, they measured 10.9 mm at the SFJ and 6.3 mm at the proximal thigh ($p < 0.001$ each). Measurement at the PT revealed higher sensitivity and specificity to predict reflux and clinical class: Sensitivity to predict reflux was 0.80 and specificity was 0.88 at the PT. Sensitivity for clinical class was 0.78 and specificity was 0.67 the SFJ. Significant correlations were found with clinical disease classes for the whole sample (Pearson's $r=0.46-0.54$; $p < 0.001$) and for legs with reflux alone (Pearson's $r=0.39-0.42$, $p < 0.001$). Thus, PT diameter may develop as the preferred surrogate parameter for specific clinical situations. That study also revealed that GSV diameter and clinical disease class did not differ between those with reflux above the knee only or those with reflux both above and below knee. This finding is in disagreement with the belief that the length of reflux in the GSV has an influence on disease severity.^{144, 145}

Neglen and Raju studied the morphologic distribution of venous incompetence by erect duplex ultrasound and descending venography and the results of AVP measurement, venous refilling time, the Valsalva test, and air-plethysmography (VFI) compared to the clinical severity class in 118 consecutive limbs (class 0: $n = 34$; class 1: $n = 42$; class 2 equivalent of C_4 of CEAP: $n = 11$; class 3 equivalent to C_{5-6} of CEAP: $n = 31$).¹⁴⁶ Twenty-nine percent of limbs with severe venous disease (class 2/3) had pure deep insufficiency, only 6% had pure superficial disease, and the remainder had a combination. A history of previous thrombosis and the presence of posterior tibial vein incompetence were markedly common with ulcer disease (84% and 42%, respectively). A duplex ultrasound multisegment score correlated strongly with clinical severity classification ($r = 0.97$). The venous refilling time and VFI had the highest sensitivity for identifying severe venous disease (class 2/3), and the ambulatory venous pressure had excellent specificity. The authors concluded that for noninvasive determination of reflux, the combination of

VFI and duplex ultrasound scanning not only localized reflux but also separated severe clinical venous disease from mild disease with high sensitivity and specificity.

Leg volume changes

Changes in blood volume and blood flow in limbs as a result of exercise were measured traditionally using plethysmography. Initially, this was with water or impedance and more recently by strain-gauge or foot volumetry.¹⁴⁷⁻¹⁵⁴ However, development of air-plethysmography (APG) which could provide volume changes of the whole leg from ankle to knee in absolute units has contributed to a better understanding of venous hemodynamics.^{155, 156}

The pressure-volume relationship

The pressure-volume relationship, method of calculation of venous distensibility, compliance and elastic modulus in normal veins have been presented in Chapter 1.

Comparison of elasticity in normal and varicose veins demonstrated a higher elasticity (i.e. a higher stiffness in filled veins) with varicose veins.¹⁵⁷ For this study, the authors used foot volumetry and direct pressure measurements recording refilling of the veins after exercise. Eiriksson and Dahn,¹⁵⁸ measured volumes at thigh cuff pressures of 30, 50 and 70 mmHg in 40 normal limbs and 46 limbs with varicose veins. Larger volumes were measured at the higher cuff pressures in the limbs with varicose veins indicating that distensibility was higher than in normal limbs because of a higher capacity.

Kidd and Lyons studied the pressure-volume relationship for changes in venous tone associated with temperature change,¹⁵⁹ to show the effect of venoactive medications,^{160, 161} exercise,¹⁶² menstrual cycle, pregnancy and oral contraceptives.^{163, 164}

It is apparent that a standard method to study the mechanical function of the venous wall has not been established. One of the problems associated with the various methods for analysis used in the above studies is that they do not discriminate the increases in volume associated with stretching of the vein wall from those due to changes in vein configuration. This problem has been overcome by using the section of the pressure-volume curve above a pressure of 20 mmHg which deter-

mines the point at which the vein wall begins to stretch.² This is because *in vitro* findings suggest that a transmural pressure of 20 mmHg ensures that the vein is circular in cross-section and allowing for tissue pressures, a corresponding pressure *in-vivo* might be achieved at internal vein pressures of 25-30 mmHg. This then allows the elastic modulus (K) to be calculated defined as stress/strain when the veins are full (Chapter 1). Calculations were made in 19 normal legs, 33 legs with superficial varicose veins, 16 legs with deep venous reflux and 18 normal legs defined as “high risk” because of the presence of varicose veins in the contralateral leg. The results showed a clear difference in elasticity between normal limbs and limbs with varicose veins, and also between normal and high risk limbs, whereas there was no difference in values of K between legs with superficial varicose veins, legs with deep venous reflux and the “high risk” normal legs (Figure 4.12).

Leg volume changes with posture and exercise

Using the manoeuvres described in Chapter 1 (Figure 1.8), APG showed changes in venous volume (VV) in ml, amount of reflux in the form of venous filling index (VFI) in ml/sec, the ejected volume (EV) in ml and ejection fraction (EF) of the calf muscle pump, as well as the residual volume (RV) in ml and residual venous fraction after 10 tiptoe movements. The high reproducibility of these measurements with coefficients of variation of less than 10% for all measurements^{155, 165} enabled the investigators to demonstrate differences in different pathologic situations and improve our understanding of venous hemodynamics.^{56, 155, 166}

By changing from the supine position with leg elevation to the standing position with support to avoid any leg muscular contractions, there was an increase in leg VV of 100-150 ml in normal limbs and 100-350 ml in limbs with CVI.

The rate of filling (VFI) of the leg venous “reservoir” varied from 2 ml/sec in normal limbs up to 25 ml in the presence of deep axial reflux (Figure 3.13). A VFI of 2 ml/sec or less indicates absence of significant venous reflux and shows that veins are filling slowly from the arterial circulation. A VFI greater than 7 ml/sec was associated with a high incidence of skin changes, chronic swelling and ulceration (see Chapter 10), irrespective of whether reflux was in the superficial or deep venous systems.⁵⁶ Ap-

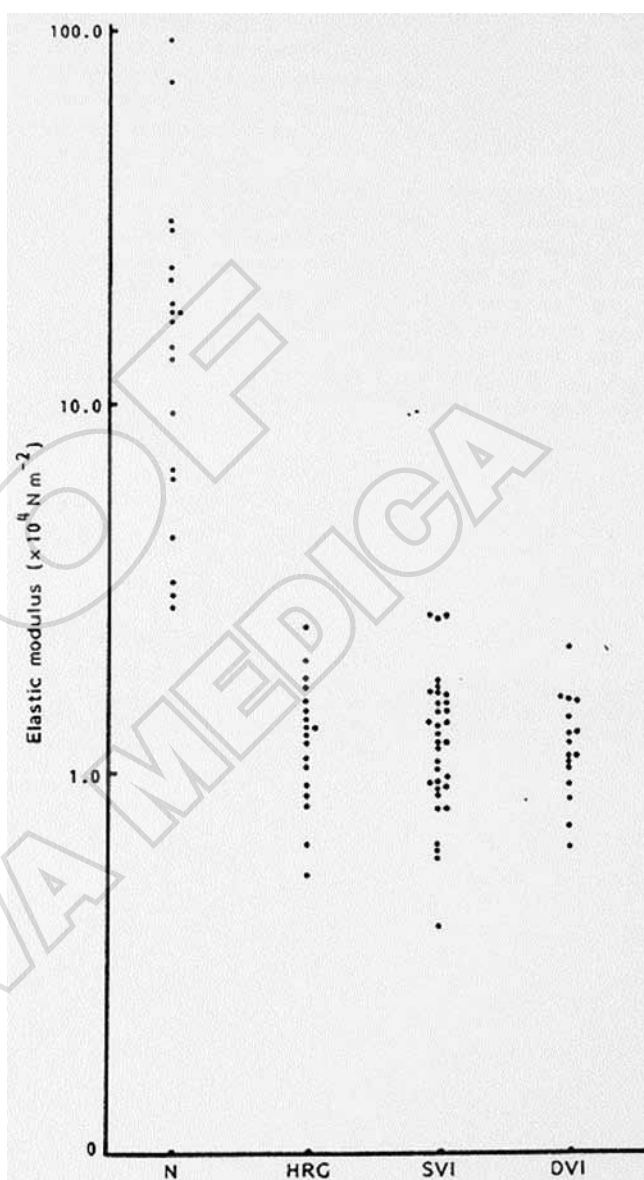

Figure 3.12.—The elastic modulus K for the normal limbs and limbs with chronic venous disease. N=normal; HRC=High risk group; SVI=superficial vein incompetence; DVI=deep vein incompetence

plication of a narrow pneumatic tourniquet (2.5 cm wide) which occluded superficial veins just below the knee reduced VFI to less than 5 ml/sec in limbs with primary varicose veins and competent popliteal valves (Figure. 3.13) but not in limbs with incompetent popliteal valves on duplex ultrasound.¹⁵⁶ However, the strong application of inelastic bandages was able to normalise elevated VFI

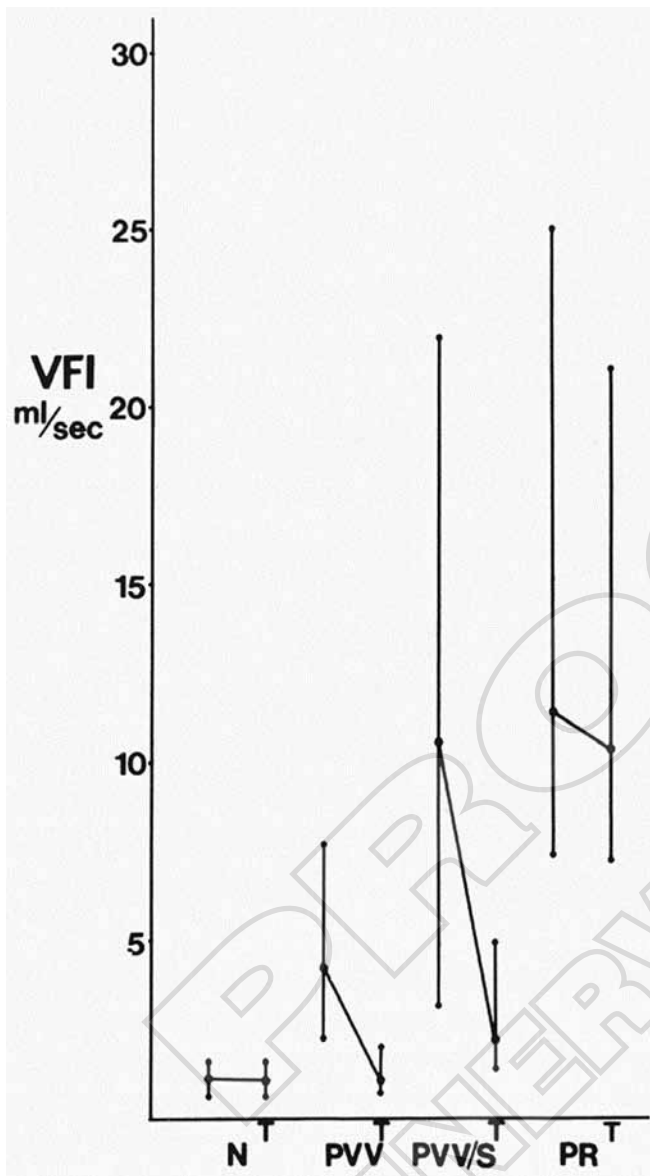

Figure 3.13.—Venous filling index (VFI) (median and 90% range) without and with a tourniquet (T) that occluded the superficial veins at the knee in normal (N) limbs, limbs with primary varicose veins without sequelae of chronic venous disease (lipodermatosclerosis and ulceration) (PVV), primary varicose veins with sequelae of CVD (PVV/S) and limbs with popliteal reflux (PR).⁵⁶

values despite popliteal incompetence.¹⁶⁷ Also, measurements before and after ligation of the SFJs or SPJs have demonstrated abolition of reflux.¹⁶⁸

The range of the ejection fraction (EF) values following one tiptoe movement in the same limbs is shown

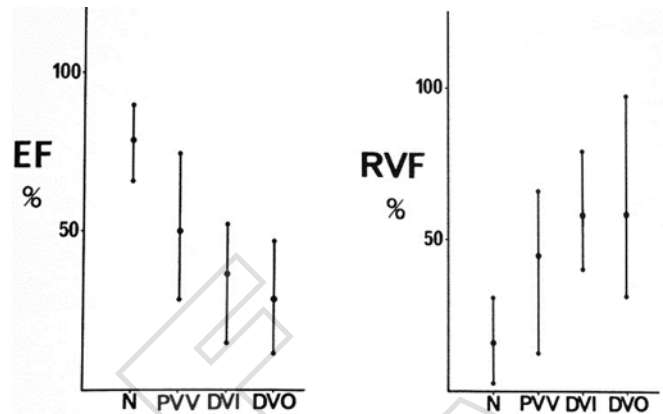

Figure 3.14.—(a: left) Ejection fraction (EF) (median and 90% range) and (b: right) residual venous fraction in normal (N) limbs, limbs with primary varicose veins (PVV), deep venous incompetence (DVI) and deep venous obstruction (DVO).

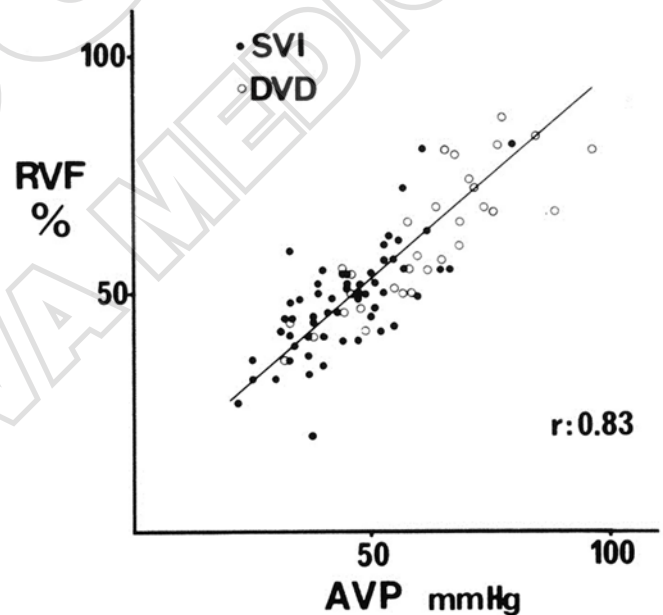

Figure 3.15.—Relationship between residual venous fraction (RVF) and ambulatory venous pressure (AVP) at the end of 10 tiptoe movements (open circles: limbs with deep venous disease; closed circles: limbs with superficial venous incompetence).¹⁵⁵

in Figure. 3.14a, and residual volume fraction after 10 tiptoe movements is shown in Figure. 3.14b. There was a good linear relationship between RVF and AVP at the end of the 10 tiptoe movements (Figure 3.15)

An other study involving 132 limbs ($C_1=16$; $C_2=30$; $C_3=20$; $C_4=25$; $C_5=21$ and $C_6=20$) studied with both du-

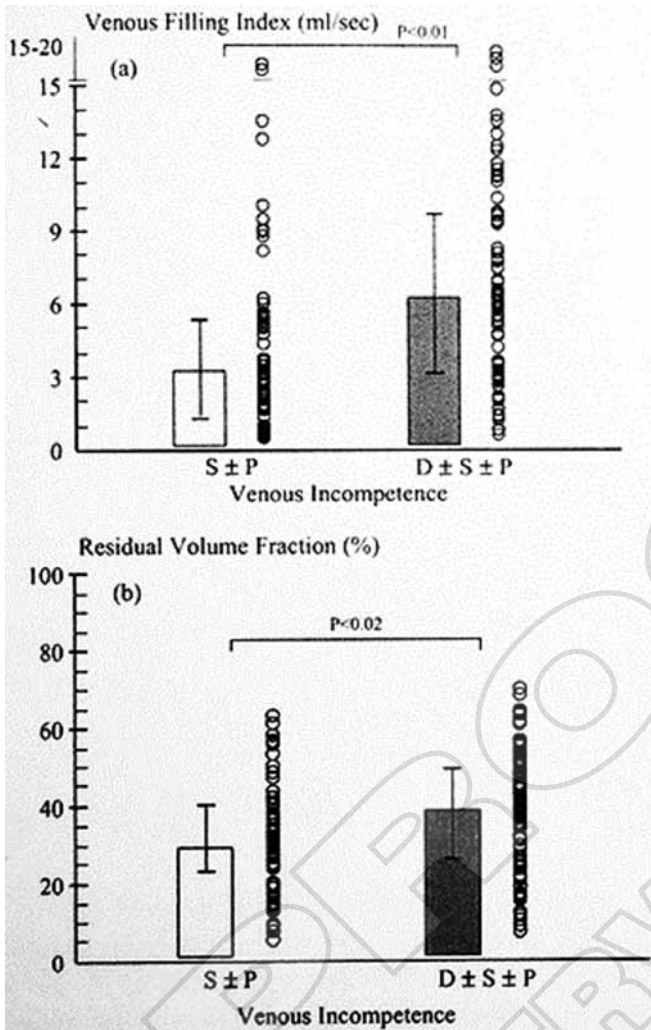

Figure 3.16.—Venous filling index (VFI) (a) and residual volume fraction (RVF) (b), presented as median and interquartile range (left) and scattergram (right), in 60 limbs with superficial (S) ± perforating vein (± P) incompetence, and 71 limbs with deep (± S, ± P) incompetence (Mann-Whitney test).

plex ultrasound and APG demonstrated that reflux (VFI) and residual volume fraction (RVF) increased when both superficial and deep veins were incompetent and also with an increasing number of systems involved. Superficial (S), perforating (P) or deep (D). (Figure 3.16).¹²⁵

Measurements of venous outflow obstruction

Severe venous outflow obstruction causing swelling and venous claudication frequently causes elevated ve-

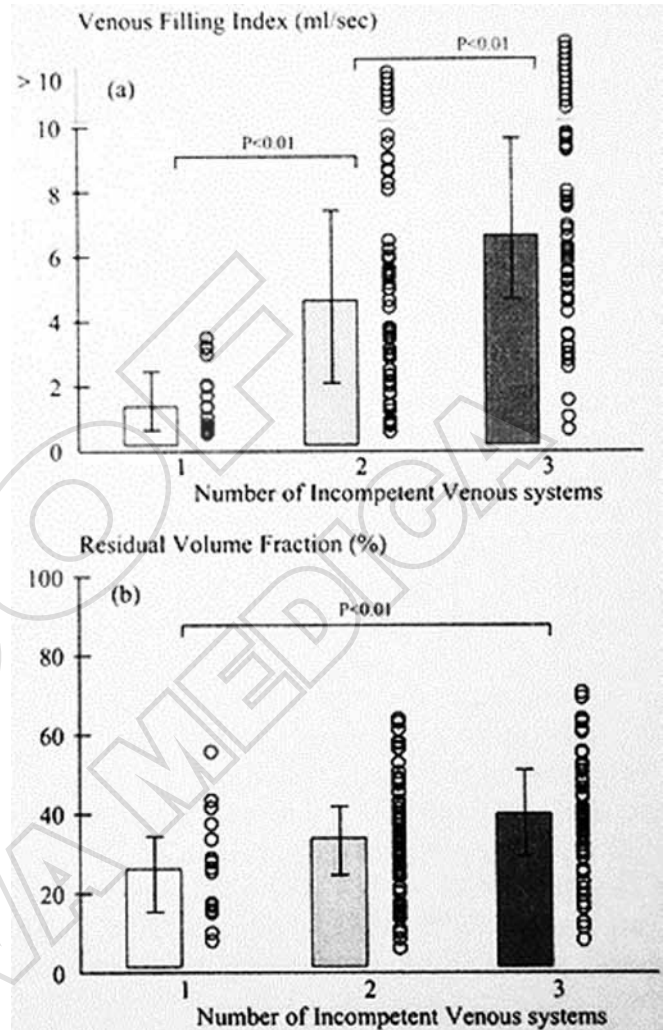

Figure 3.17.—Venous filling index (VFI) (a) and residual volume fraction (RVF) (b), presented as median and interquartile range (left) and scattergram (right), in 16 limbs with single venous system incompetence, 62 limbs with dual system incompetence, and 54 limbs with triple system incompetence. Both VFI and RVF increased overall with the number of incompetent venous systems ($p < 0.01$ for trend, Kruskal-Wallis).

nous pressure at rest and during exercise. Outflow obstruction should be suspected when swelling is the predominant feature. It may be associated with a history of deep vein thrombosis and with development of prominent collateral venous channels in the groin, above the pubis or on the anterior abdominal wall. Severe outflow obstruction is particularly suspected in patients with venous claudication post thrombosis.

Simple leg elevation with the patient supine can provide an estimate of the resting venous pressure by ob-

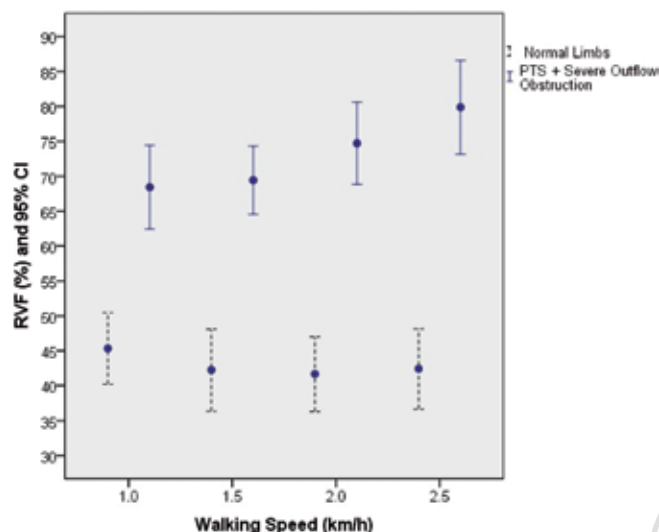

Figure 3.18.—Residual volume fraction (RVF) during walking in 12 normal limbs and 7 limbs with severe outflow obstruction.

serving the height (in cm) of the heel above the heart level at which prominent veins in the foot collapse. A study that measured direct femoral vein pressures in patients with iliofemoral occlusion demonstrated by venography showed that the average resting pressure in the supine position in those with poor pelvic collaterals was 5.5 ± 10.5 mmHg higher than the unobstructed opposite limb, whereas, the gradient between the two limbs in those with good collateral veins was 0.6 ± 1.4 mmHg.¹⁶⁹

In the presence of a stenosis a peak velocity ratio of >2.5 across the stenosis is the best criterion to use for the presence of a pressure gradient >3 mm Hg.¹⁷⁰

Several methods have been used to quantify outflow obstruction or indirectly measure its severity - RVF during exercise, maximum venous outflow or outflow fraction, arm-foot pressure differential and venous outflow resistance.

Venous volume during walking

In one study they measured the RVF using APG during walking on a treadmill in 12 normal limbs of healthy volunteers and 7 limbs with axial vein reflux combined with severe outflow obstruction due to a previous DVT followed by poor recanalization.¹⁷¹ Walking speeds were 1.0, 1.5, 2.0 and 2.5 km/h. In normal limbs, the RVF was 45% (95% CI 42% to 50%) at 1.0 km/h

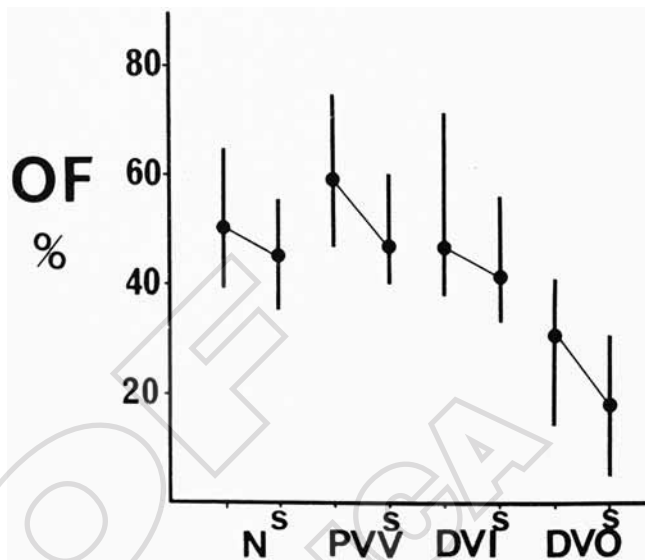

Figure 3.19.—Outflow fraction (OF) (median and 90% range) without and with (s) occlusion of the superficial veins in limbs of 50 normal volunteers (N), 157 limbs with primary varicose veins (PVV), 70 limbs with deep venous incompetence (DVI) and 68 limbs with venographic deep venous occlusion (DVO).

decreasing to 42% (95% CI 37% to 48%) ($P > 0.05$) at 2.0. In limbs with severe outflow obstruction RVF was 68% (95% CI 62% to 74%) at 1.0 km/h increasing to 79% (95% CI 73% to 86%) (P for trend = 0.009) (Figure. 3.18). According to Figure. 3.15, this RVF of 79% approximately corresponds to an AVP of 80 mmHg.

Maximum venous outflow and outflow fraction

The presence and extent of deep venous obstruction suspected from clinical and ultrasound examination can be confirmed by venography, CT- or MRI-venography or IVUS. However, the functional severity of the obstruction is difficult to assess from these imaging investigations. Quantitative measurements are obtained from the maximum venous outflow (MVO) using strain gauge plethysmography or APG. Initially, a proximal thigh cuff is inflated to 80 mmHg with the limb elevated 10 degrees and the veins are allowed to fill. The cuff is suddenly deflated and measurements are made from the outflow curve.^{172, 173}

Strain-gauge plethysmography recording MVO was an established screening method for detecting DVT in the 1970s.^{174, 175} Normal limbs had a MVO greater than 45ml/100 ml/min. In approximately 90% of patients

who had an abnormally low MVO soon after DVT (see chapter 2), values close to the lower limit of normal were found one year later presumably because of recanalization and development of collateral channels. However, in 10% of patients, the MVO remained grossly abnormal and these patients remained severely incapacitated often due to persisting venous claudication.

By 1989, the one second venous outflow fraction could be measured using APG.^{172, 173, 176} and it was found that this was more than 38% of the venous volume in normal limbs, 30-38% in limbs with mild to moderate obstruction and less than 30% in limbs with severe obstruction. Provided that superficial veins acting as collateral channels had been occluded, a good separation was obtained between limbs with and without venographic obstruction (Figure 3.19)

The ability of the APG one second outflow fraction (OF) to discriminate between limbs with arm-foot pressure differential (ΔP) lower or higher than 5 mmHg is shown in Figure 3.20.

Gravitational Venous Drainage

The venous drainage index (VDI) in ml/s is a recently introduced parameter of APG.¹⁷⁷ It is the exact opposite of the VFI. The VDI quantifies the rate of calf decompression from a position of dependency to elevation. It is intuitive that a slow rate of calf decompression, which occurs in obstruction, will have a poor response to gravitational drainage. This has been validated in healthy controls using graduated thigh-cuff pressures to simulate degrees of obstruction.¹⁷⁸ Using a tilt-table comparing healthy controls with patients of known obstruction, the cut-off point in determining presence of obstruction was a VDI <11 ml/s.¹⁷⁹ In a subsequent study VDI was reduced significantly in response to iliac venous stenting.¹⁸⁰

Arm-Foot pressure differential

The arm-foot pressure differential has been used by Raju as another means to assess the functional severity of outflow obstruction.¹⁸¹ This method consists of recording the venous pressure in veins of the foot and hand simultaneously with the patient in the supine position at rest. The measurements are repeated after inducing reactive hyperemia. In normal limbs, the arm-foot pressure differential (ΔP) was less than 5 mmHg at

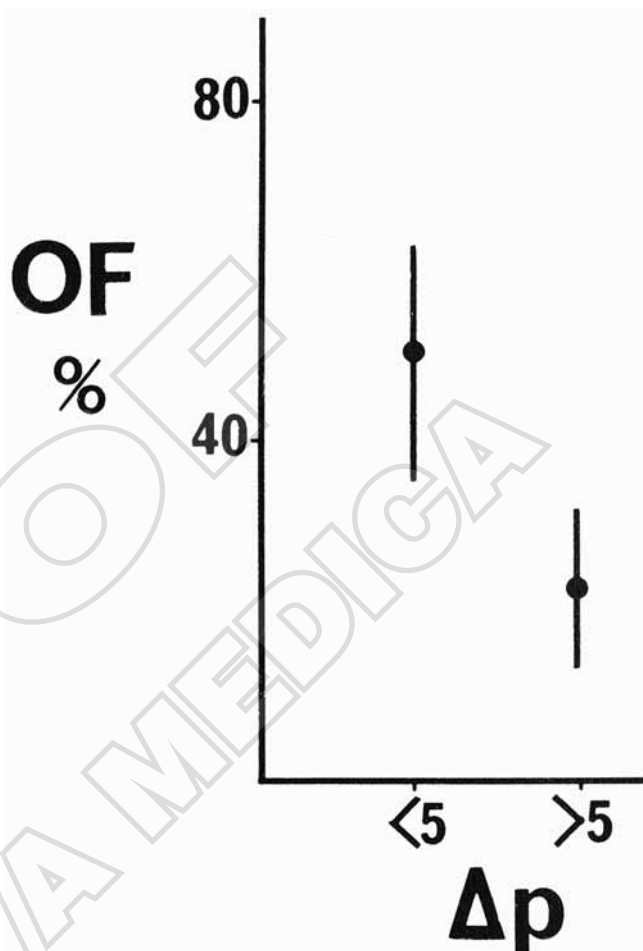

Figure 3.20.—Outflow fraction (OF) (median and 90% range) in 15 limbs with deep venous reflux but no obstruction (arm-foot ΔP < 5 mmHg) and 8 limbs with venographic deep venous obstruction (arm-foot ΔP > 5 mmHg).

TABLE 3.4.—Arm-foot pressure differential (ΔP mmHg) in limbs with outflow obstruction.

Grade	ΔP at rest	ΔP increment during hyperemia
I Fully compensated	< 5	< 6
II Partially compensated	< 5	> 6
III Partially decompensated	> 5	> 6 (often 10-15)
IV Fully decompensated	> 5 (often 15-20)	No further increase

rest and rose to 6 mmHg during reactive hyperemia. In patients with venographic evidence of outflow obstruction, the measurements allowed limbs to be classified into four grades (Table 3.4).

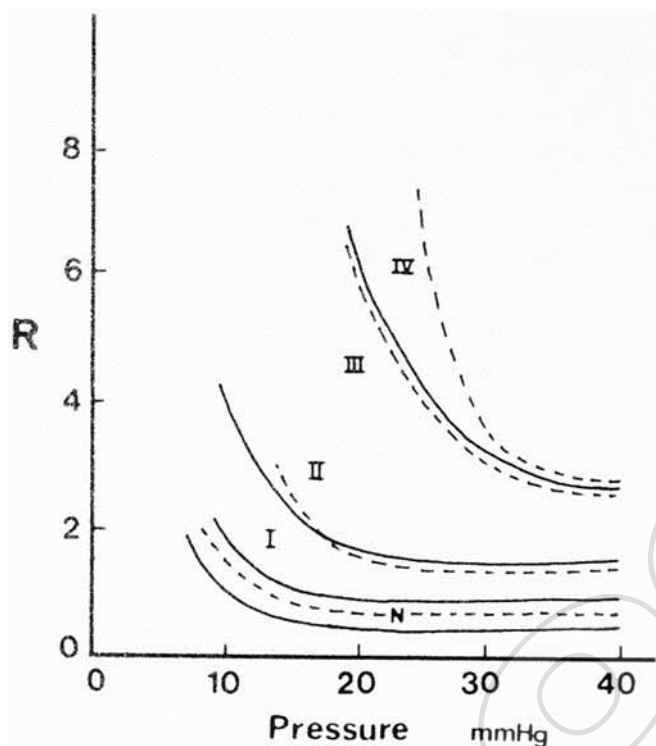

Figure 3.21.—Relationship between outflow resistance curves and Raju classification of Grades I-IV outflow obstruction (N: normal limbs).¹⁸²

Venous outflow resistance

As indicated in Chapter 2, venous outflow resistance can be calculated from the outflow curves of volume and pressure obtained simultaneously (Figure 1.9).^{182, 183} By measuring outflow resistance in a large number of patients without (N) and with various grades of obstruction (Raju test: Grades I-IV), a relationship between the two methods has been found (Figure 3.21). However, it should be pointed out that the measurement of resistance when a proximal thigh cuff causes pressure in the veins to be greater than 20 mmHg is far from physiological, since resting pressures rarely exceed 15 mmHg. A method for measuring outflow resistance at physiological pressures is required.

Hemodynamic changes in the microcirculation

Microcirculation is the term used to describe vessels with mean internal diameter smaller than 100 μm with-

in organs that are responsible for distribution of blood within tissues and whose spatial arrangement depends upon the tissue specific structure and functions. They include arterioles, venules, capillaries (size ranges 4-10 μm), arterio-venous anastomoses in the skin of the extremities, and also lymphatic capillaries and lymphatic collecting ducts. In the skin, the capillaries are mainly located in the superficial, papillary layer of the dermis, where the nutritional needs are important, whereas the venules and arterioles are arranged in two to four superimposed parallel networks in the dermis for thermoregulatory purposes.

Venous leg ulcers and the other skin changes of chronic venous insufficiency are related to a specific venous microangiopathy, also named venous hypertensive microangiopathy according to the main pathophysiological disturbance in the venous microcirculation. This microangiopathy can be observed noninvasively through standard and OPS (orthogonal polarisation spectral imaging) capillaroscopy, and its consequences measured by laser Doppler flowmetry, transcutaneous PO_2 (TcPO_2) and plethysmography.

Blood flow maldistribution

From a hemodynamic point of view, the most striking feature of venous microangiopathy is the contrast between an abnormally increased skin blood flow, and a decreased oxygen delivery to the tissue.

The first evidence about this paradox derives from the observation, in the 1950's, of an early venous return observed in arteriograms combined with an increased oxygen content in the efferent blood in the limbs of patients with post-thrombotic syndrome or varicose veins.¹⁸⁴⁻¹⁸⁷ The proposed explanation at that time was an opening of arterio-venous anastomoses, but subsequent isotope-labeled microsphere studies ruled out the existence of such anatomic shunts.¹⁸⁸

The most striking evidence of the inefficient oxygen delivery to the skin tissue in spite of a high blood flow was elegantly provided by the PET-scan study of Hopkins *et al.* in 1972,¹⁸⁹ which showed that at the same site in patients with leg ulcers, blood flow was very much increased and O_2 extraction very much decreased compared with the contralateral leg.

This was interpreted as an O_2 diffusion block by Burand and Browse, who in parallel had found pericap-

illary fibrin deposits in patients with leg ulcers¹⁹⁰ and a correlation of an increased number of capillaries in histological skin samples of patients with ambulatory venous hypertension.¹¹⁵ However, the capacity of fibrinogen to block oxygen diffusion was questioned and it was soon realized that the increased number of capillary sections in the skin ulcer area was due to the circumvolutions of capillaries that were actually decreased in number, as shown by capillaroscopy.¹⁹¹

Eventually, the decrease in O₂ was explained by the reduction in subepidermal capillary density and increased O₂ diffusion distance.¹⁹¹ It was also realized that the increase in flow, confirmed by many laser-Doppler studies,¹⁹²⁻¹⁹⁶ took place in the deeper layers of the dermis, probably related to an abnormal vasomotor regulation or stimulated by the tissue hypoxia/acidosis and inflammation.^{194, 197}

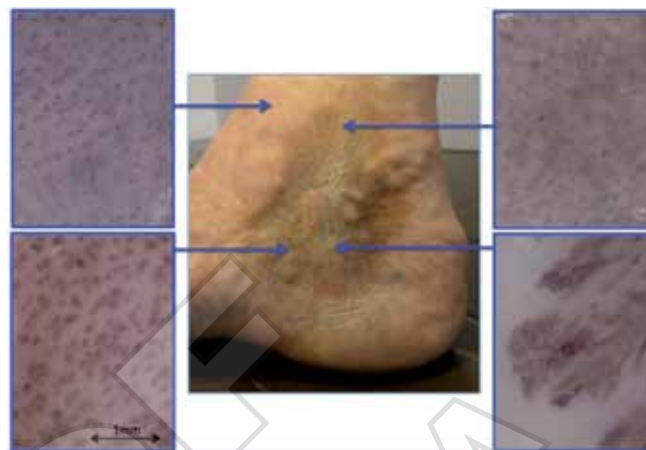

Figure 3.22.—Capillaroscopic pictures in several areas of the right leg in a 68 years male patient with post-thrombotic syndrome (from P Carpentier).

Alteration of interstitial capillaries and edema formation

Changes in hemodynamics of veins that result in venous hypertension are transmitted into the microcirculation to increase hydrostatic pressure in capillaries. This results in transcapillary filtration that exceeds lymphatic drainage so as to contribute to interstitial edema formation. Venous hypertension slows blood flow in capillaries prompting leukocyte adhesion to capillary endothelium and initiating an inflammatory reaction.¹⁹⁸ One theory holds that inflammation opens gaps between endothelial cells through a mechanism involving vascular endothelial growth factor (VEGF), nitric oxide synthetase (NOS), and contraction of actin and myosin filaments present in endothelial cells.¹⁹⁹ If the gaps become very large then greatly raised capillary permeability to fluid and macromolecules, even allowing extravasation of red blood cells, results in their flow into the interstitial space with edema formation. Swollen endothelial cells with enlarged intercellular spaces make the capillary lumen irregular. The consequent increase on macromolecular permeability causing plasma, fibrinogen and red blood cell leakage, impairs nutrient exchange.^{190, 192} Sustained venous stasis and hypertension lead to chronic inflammation in the capillary bed and surrounding tissues and chronic edema.^{200, 201} Subsequent reduced capillary density could cause trophic disorders and leg ulceration.¹⁸²

Alteration of skin capillaries and venous ulcer formation. Spatial heterogeneity of venous microangiopathy

Skin is the final target of chronic venous hypertension and hemodynamic changes in veins. Clinical manifestations caused by alteration in skin capillaries are pigmentation, venous eczema, lipodermatosclerosis, atrophie blanche and eventually venous ulceration. Several mechanisms for the development of venous ulcers have been postulated of which the theory of “leukocyte trapping” is the most likely.²⁰² It is hypothesized that the primary injury to skin is extravasation of macromolecules such as fibrinogen and macroglobulin as well as red blood cells causing pigmentation into the dermal interstitium. Red blood cell degradation products and extravasation of interstitial proteins are potent chemoattractants and presumably generate an initial inflammatory signal that results in leukocyte recruitment and migration into the dermis.¹⁹⁸ Pathologic events occur during leukocyte migration into the dermis and the end product is dermal fibrosis. As indicated at the beginning of this chapter, one of the pathologic events is an increase in transforming growth factor beta-1 (TGF-β1), released by macrophages and mast cells or auto-induced by dermal fibroblasts. An increase in TGF-β1 causes an imbalance in tissue remodeling which results in increased collagen synthesis and affects matrix me-



Figure. 3.23.—The orthogonal polarization spectral (OPS) imaging technique used in the Cytoscan has allowed the study of alterations of skin capillaries in patients with chronic venous disease.(Courtesy of E Bouskela).

talloproteases (MMPs) as well as their tissue inhibitors (TIMPs). It is hypothesized that an imbalance in MMPs and their regulation may cause or contribute to venous ulcer formation. A cascade of inflammatory events results in cutaneous changes which include skin hyperpigmentation caused by hemosiderin deposition and eczematous dermatitis. Fibrosis may develop in the dermis and subcutaneous tissue lipodermatosclerosis. There is an increased risk of cellulitis and leg ulceration. A linear relationship between ulceration rate and ambulatory venous pressure has been demonstrated.²⁰³

Since the early days of capillaroscopy, the simple and noninvasive observation of the papillary capillaries through the epidermal layer with a magnifying instrument has shown a decrease in capillary density, an increase in capillary size and tortuosity and a heterogeneity of these parameters. Gilje²⁰⁴ was the first to show these abnormalities, which were subsequently precisely described by Fagrell,²⁰⁵ who showed that the capillaroscopic picture was different in pigmented areas, in lipodermatosclerotic skin and in atrophic blanche or ulcer scar. Indeed, on the same limb, the capillaroscopic pattern can range from normal to almost avascular areas which are but huge glomerulus-like capillaries (Figure 6). Franzeck and Bollinger quantified the deficit in capillary density that was linearly related to the $TcPO_2$.¹⁹¹

Over the last ten years, an improved capillaroscopic technique, the orthogonal polarisation spectral (OPS)

imaging technique used in the Cytoscan has allowed alterations of skin capillaries to be studied in patients assigned C_1 to C_6 of the CEAP classification (Figure. 3.23). The Cytoscan has a small handheld probe which can be noninvasively applied to all body surfaces to evaluate microcirculatory parameters such as functional capillary density (FCD, capillaries/ mm^2), diameter of dermal papilla (DDP, μm) to quantify edema, the largest diameter of the capillary bulk (DCB, μm) to assess its degree of change, capillary limb diameter (CD, μm) to describe diameter changes, and capillary morphology (CM, % of abnormal capillaries per field). It was demonstrated that all of these values were progressively altered from C_1 to C_6 patients and that values in CVD patients were significantly different from these in healthy subjects ($P < 0.05$).²⁰⁶

Alteration of lymphatic vessels

The function of lymphatic vessels is very important. They are involved in the recirculation of lymphocytes and proteins, transport of microorganisms by lymph and drainage of interstitial fluid to blood. The average human body weighing 65 kg contains 3 L of blood plasma and 12 L of interstitial fluid. Up to 8–12 L of afferent lymph are produced each day of which 4–8 L of ultrafiltrate are reabsorbed into the bloodstream. The concentration of proteins in plasma, interstitial fluid, afferent lymph, and efferent lymph is 70 g/L, 20–30 g/L, 20–30 g/L, and 60 g/L, respectively. The fluid turnover reaches up to two-thirds of the total volume of interstitial fluid daily.²⁰⁷ The skin on the lower extremities contains a denser and more extensive network of lymphatic capillaries than the skin of the upper extremities.²⁰⁸ Due to orthostatism, lower extremities have higher filtration pressure and influx of fluids, and it is thought that the capacity for lymph transport in the lower extremities is greater in order to compensate for the higher influx of interstitial fluid caused by the effects of orthostatism and gravity.

Spontaneous contractility of lymphatic vessels contributes to lymph transport. Regular contractions of lymph vessels at a frequency of 2–4 per minute were observed *in vitro* and spontaneous contractions of prenodal lymphatic vessels that drive lymph have been observed in human legs.²⁰⁹ Internal extensions of lymphatic endothelial cells act as valves and guarantee a one-way lymph flow.²⁰⁷

In a steady state, extravasation of fluids and proteins from blood vessels is balanced by lymphatic drainage and return into the bloodstream. If microvascular filtration in blood capillaries and venules as occurs in advanced CVD exceeds the capacity for lymphatic drainage for sufficiently long periods, edema develops in afflicted areas by accumulation of tissue fluid in the interstitium. In addition, lymphatic dysfunction and structural damages to the lymphatic network are associated with varicose veins, and subsequent lymph stasis and reduced lymph transportation lead to inflammation.²¹⁰ This is associated with lipid accumulation in the media of the diseased veins. Such accumulation of inflammatory lipids in the vein wall might further damage adventitial lymphatic vessels.

Normal Skin blood flow

Only 5-10% of the total skin blood flow is through nutrient capillaries that reach the outer layers of the dermis.^{191, 205} The number of capillary nutrient loops per unit area is related to the TcPO₂ in that the smaller the number of nutrient capillary loops per mm², the lower is the TcPO₂.¹⁹¹

The output signal from laser Doppler flowmeters is directly proportional to blood flow in the microcirculation and particularly in superficial (< 1mm depth) skin vessels detecting flow in subpapillary plexuses, superficial shunts and capillaries. Laser Doppler probes record red cell flux (a function of the number of red cells and their velocity) in a small volume of approximately 1 mm³. One of its advantages is the ability to record vasomotor activity which produces rhythmic fluctuations in blood flow. Vasoconstriction alternates with vasodilatation of arterioles, often differing in adjacent areas. Arteriolar vasomotor activity acts as a local regulatory mechanism for blood flow and determines total skin blood flow. In pathological situations such as inflammation, allergic reactions and venous hypertensive microangiopathy, vasomotor activity may be reduced or abolished with generalised vasodilatation resulting in a marked increase in skin blood flow by up to 5 times.

The postural venoarteriolar response (VAR)

In normal limbs, the precapillary resistance in the skin of the foot and perimalleolar region increases on standing producing a decrease in capillary blood

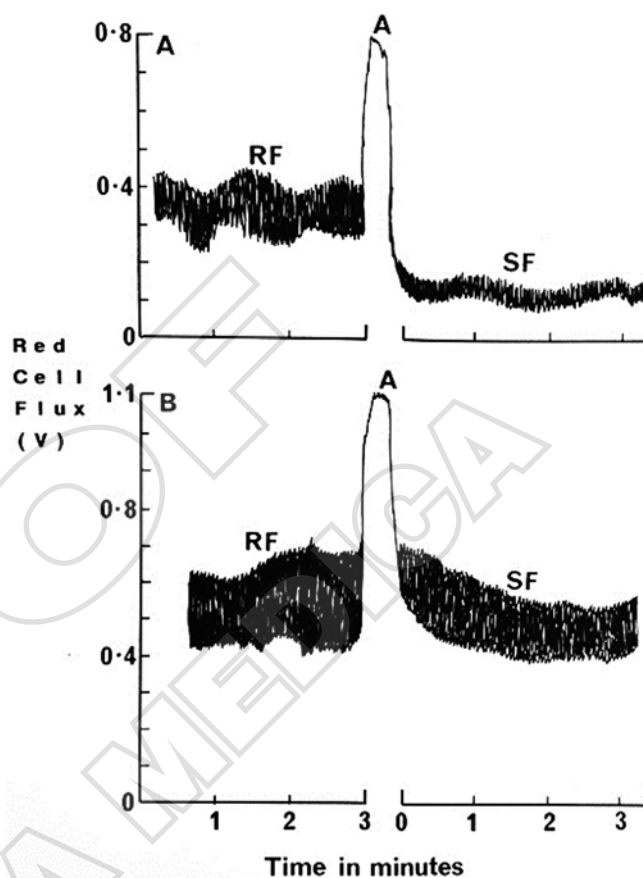

Figure 3.24.—Red cell flux in a normal limb (above) and in a limb with venous hypertension (below) (RF = resting flux; SF = standing flux). Note the presence of vasomotor waves at RF and the decreased red cell flux on standing (SF) as a result of the venoarteriolar response in the normal limb; also the absence of vasomotor waves and high red cell flux both at rest and on standing indicating the absence of venoarteriolar response (A = movement artefact).

flow.^{211, 212} This response minimises the number of capillaries exposed to a high pressure and flow in the standing position, limiting the increase in capillary pressure determined by the vertical column of blood between the heart and the foot.²¹³ It has been suggested that this vasoconstrictory response or venoarteriolar response (VAR) is mediated by a sympathetic axon reflex.^{211, 212} Absence or reduction of the VAR exposes a large number of capillaries to high pressure on standing and is associated with increased capillary leakage and ankle edema.

The VAR in a normal limb and its absence in a limb with venous hypertension can be shown by laser Doppler flowmetry (Figure 3.24). A recording shows that

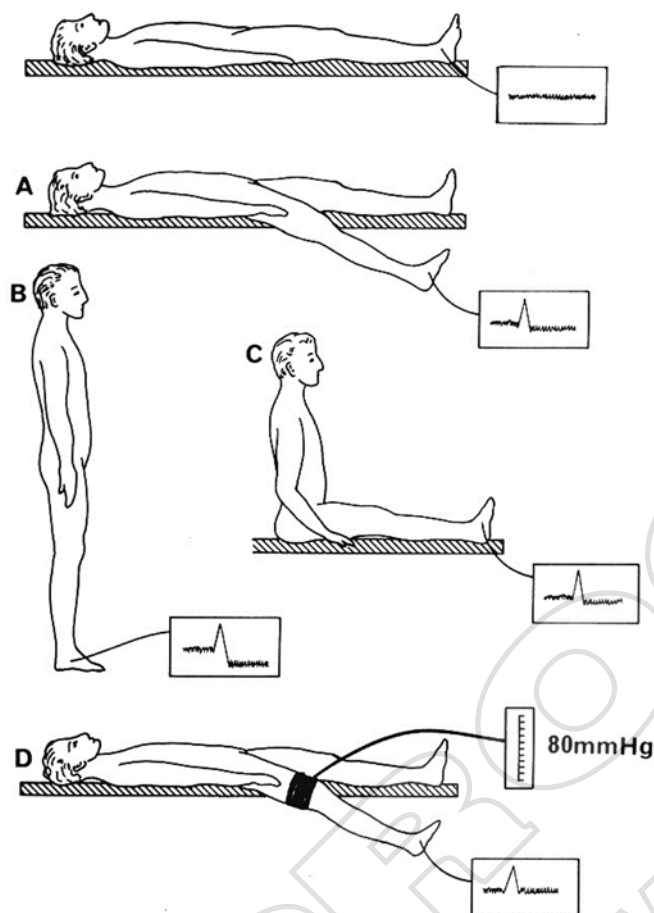

Figure 3.25.—The venoarteriolar response may be induced by foot dependency (A), standing (B), sitting up (C) or increasing the venous pressure by inflating a thigh tourniquet. In patients with chronic venous insufficiency and severe venous hypertension, the venoarteriolar response is absent or minimal.

in a limb with venous hypertension (lower tracing), there is an increase in the skin red cell flux indicating increased skin blood flow at rest (RF= resting flux) with reduction of the normal vasomotor activity in the supine position followed by absence of the VAR on standing.^{193, 195} Lowering the leg and foot below the horizontal in a normal subject elicits the VAR producing a small decrease in skin red cell flux by 10-20% (Figure 3.25), a greater decrease in skin red cell flux by 40% is observed on standing (Figure 3.25B) and a small decrease in flux is also observed by sitting up while keeping the leg horizontal (Figure 3.25C). Inflating a thigh cuff to 80 mmHg to occlude the superficial venous system will also elicit a small decrease in flux and no further de-

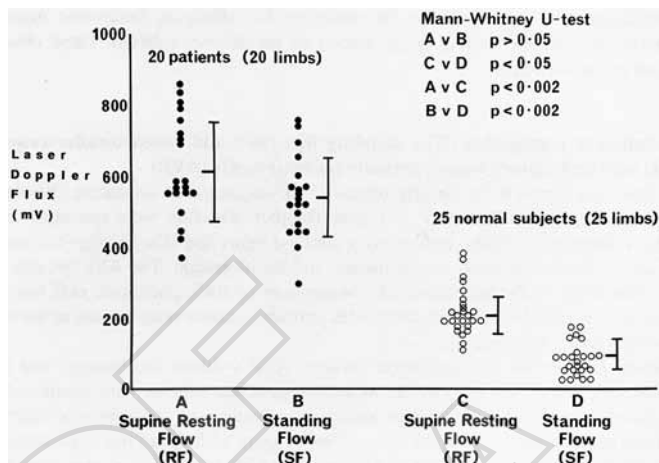

Figure 3.26.—The venoarteriolar response in 20 patients with venous hypertension and in 25 normal subjects.

crease would then be observed when the leg is lowered below the horizontal (Figure 3.25D).

Skin blood flow and the VAR in limbs with venous hypertension

The difference in the effect of the VAR between normal limbs and post-thrombotic limbs was demonstrated in a study of 20 limbs with axial reflux and 25 age and sex matched normal controls.^{195, 196} Patients were selected to have an AVP > 65 mmHg and small perimalleolar ulcers (area 1.5-3 cm²). The probe of the laser Doppler was attached to the perimalleolar region at least 1 cm proximal to the upper edge of the ulcer. Figure 3.26 shows the resting flux (RF) and standing flux (SF) in each group. The mean RF in the post-thrombotic limbs was approximately three times higher than in normal limbs. On standing, there was a small but not significant decrease in skin flux in post-thrombotic limbs whereas the decrease in flux on standing was significant in the normal limbs. The mean VAR (percentage decrease of flux on standing) was 14% in the post-thrombotic limbs and 57% in the normal controls. This physiological response elicited when venous pressure increases by 40 mmHg or more with absence or reduction of the VAR exposes a large number of capillaries to high pressure on standing and is associated with increased capillary leakage and ankle edema.

Skin flux is lower in normal limbs and there is a significant decrease in flux on standing. The latter is almost abolished in patients.

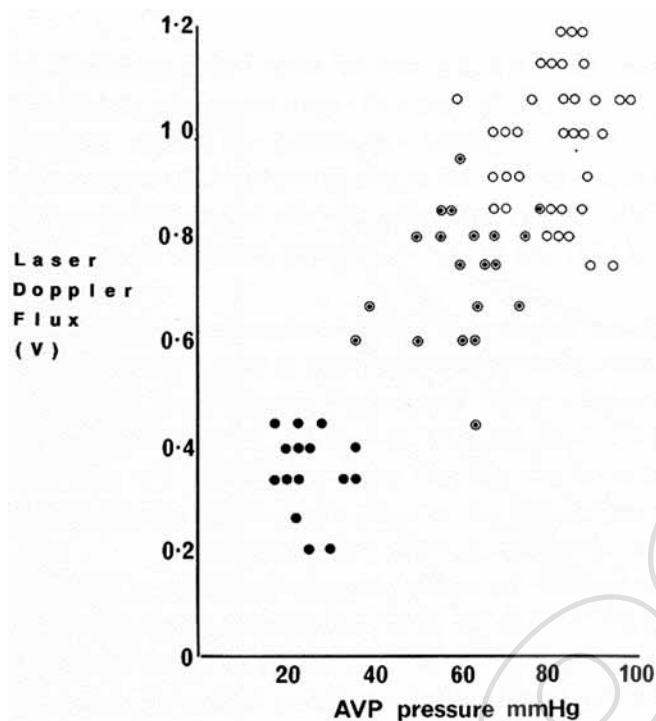

Figure 3.27.—Correlation between skin flux and ambulatory venous pressure in normal subjects (lower group), patients with moderate venous reflux due to superficial venous disease (middle group) and in patients with severe deep venous reflux (upper group).

On the basis of these findings, the authors produced the following hypothesis. In normal limbs with normal vasomotor activity when the limb is horizontal, only a portion of the capillaries, say 5 out of 10, are open at any time. On standing, the VAR results in “closing down” 2 or 3 further capillaries so that only 2 or 3 capillary loops bear the high pressure when the venous system becomes full. Thus, capillary flow is greatly reduced and capillary leakage is minimal. In contrast, limbs with severe venous hypertension have an increased skin blood flow on average by three times, and vasomotor activity is minimal indicating that most capillaries, say 9 out of 10, are open, not unlike an inflammatory reaction. On standing, the VAR is minimal so that a large number of capillaries, say 8 out of 10, remain open resulting in increased capillary leakage proportional to the area of capillary endothelium exposed to the high flow and pressure. This hypothesis was subsequently tested by further studies in which the RF, SF and VAR were correlated with

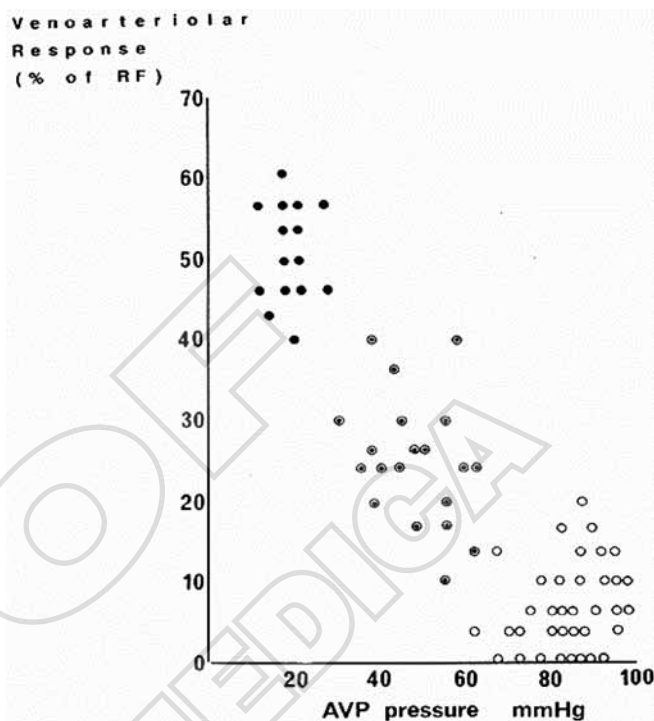

Figure 3.28.—The venoarteriolar response in the same groups as in Figure. 3.26.

AVP, TcPO₂, TCPCO₂, local skin temperature, capillary permeability, inhalation of CO₂ and finally by observing the effect of therapeutic measures known to promote the healing of leg ulcers on the microcirculation.¹⁹⁴

Correlation of resting flux (RF), standing flux (SF), and venoarteriolar response (VAR) with ambulatory venous pressure (AVP)

In a study involving 70 limbs (15 normal, 20 with primary varicose veins and skin changes (no ulceration) and 35 with deep venous disease and ulceration), there was a positive linear relationship between RF and AVP ($r = 0.84$) (Figure 3.27) and a negative linear relationship between VAR and AVP ($r = -0.79$) (Figure. 3.28).¹⁹⁴

Correlation between VAR, RF and SF with TcPO₂ and TcPCO₂

The RF, SF, VAR, TcPO₂, TcPCO₂ and AVP were measured at the primalleolar region in 20 post-throm-

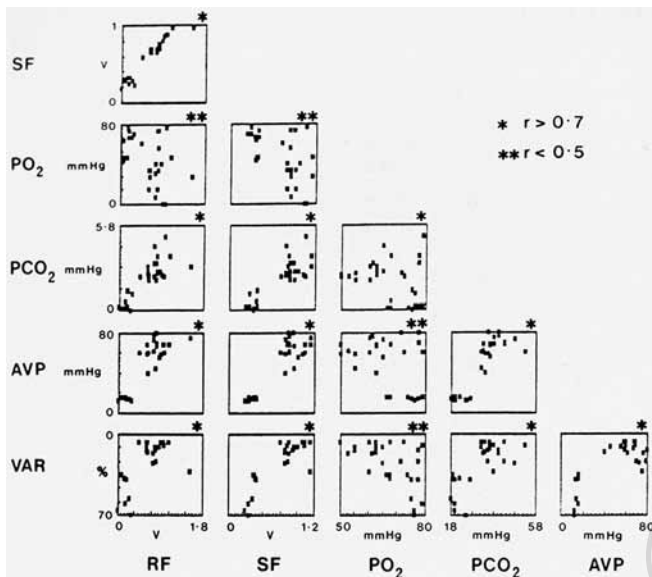

Figure 3.29.—The intercorrelation between ambulatory venous pressure (AVP) and microcirculatory parameters (SF = standing flux; RF = resting flux; VAR = venoarteriolar response) including transcutaneous PO₂ and PCO₂. The parameters with good correlation ($r > 0.7$) are indicated (*).

botic limbs with popliteal vein reflux on duplex ultrasound scanning and ten normal limbs. Intercorrelation between the parameters is shown in Figure 3.29.¹⁹³ The correlation between TcPO₂ and all other parameters was poor ($r < 0.4$) and this was not surprising because light emitted by the laser Doppler probe penetrates only the superficial part of the dermis for 1.0–1.5 mm and as such measures red cell flux in a variable depth. All other parameters are well intercorrelated ($r > 0.6$). Particularly interesting was a negative linear relationship between TcPCO₂ and VAR ($r = -0.72$). The question arose whether the increased PCO₂ was responsible for or was the result of the vasodilatation, high skin red cell flux and abolition of vasomotor activity (vasoparalysis).

In an attempt to answer the above question, the effect of CO₂ inhalation (5% for 15 minutes increasing the TcPCO₂ by 20%) was administered in ten normal volunteers. The decrease in VAR as a result of the latter is shown in Figure 4.28. This demonstrated the powerful effect of PCO₂ on the microcirculation indicating that the observed effects in venous hypertensive microangiopathy may be the effect of locally raised PCO₂.¹⁹⁴

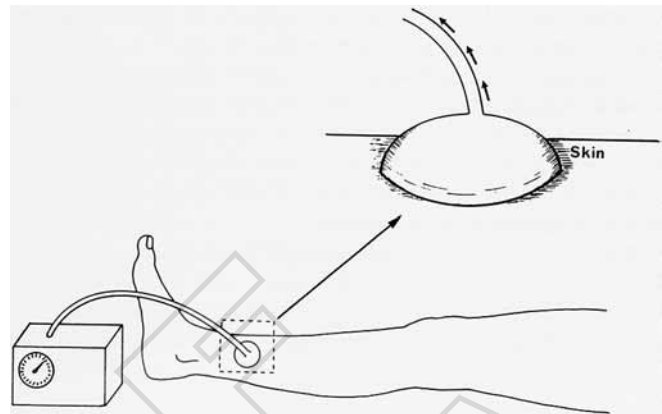

Figure 3.30.—The vacuum suction chamber device. A negative pressure (-30 mmHg) is maintained.

The venoarteriolar response and capillary filtration

In patients with diabetes and patients with venous hypertension in whom the VAR is impaired, edema may occur as a result of high capillary pressure on dependency. Thickening of the basement membranes, which is the histological hallmark of microangiopathy, is promoted by chronically raised capillary pressure.²¹⁴ In patients with venous hypertension, local capillary filtration and capillary permeability were evaluated using the vacuum suction chamber (VSC) device (Figure 3.30).²¹⁵ A small plastic chamber is applied to the skin of the perimalleolar region and a negative pressure (-30 mmHg) is produced for a period of 10 minutes. The VSC produces a wheal determined by edema which disappears in minutes or hours). Wheals are recorded by serial photos taken every 5 minutes. In normal subjects, they disappear in less than 60 minutes. The disappearance time of the wheals can be used to evaluate capillary filtration. There is a negative linear relationship between the disappearance time of the wheals and the VAR obtained in the same area (Figure 3.31).

Capillary filtration rate can also be measured using a strain-gauge applied just above the ankle. After resting for 30 minutes in the horizontal position, the subject is asked to stand holding on to a frame. After the initial increase in volume due to filling of the veins, there is a slow increase in volume due to edema. The slope between the 7th and 10th minute is considered to be a measure of capillary filtration (Figure 3.31).²¹⁶ Using this technique, it has been found that there is an increase

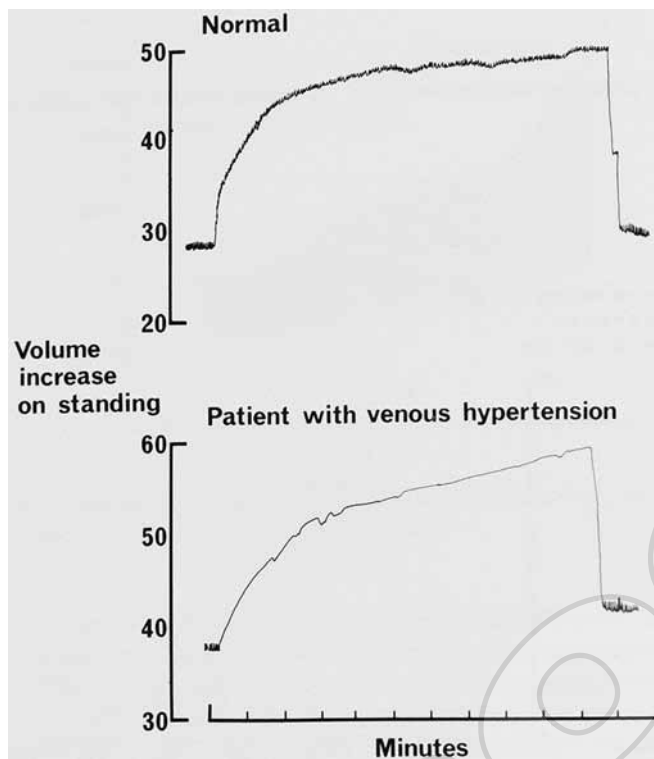

Figure 3.31.—Two curves obtained with strain-gauge plethysmography. One in a normal volunteer and one in a patient with venous hypertension. The tangent to the curve at 7-10 minutes is proportional to the capillary filtration. There is an increased capillary filtration in the patient with venous hypertension.

in the rate of ankle swelling in patients with increased skin flux due to the post-thrombotic syndrome and decrease in VAR.¹⁹⁶

References

1. Zsoter T, Cronin RF. Venous distensibility in patients with varicose veins. *Can Med Assoc J* 1966;94(25):1293-7.
2. Clarke H, Smith SR, Vasdekis SN, Hobbs JT, Nicolaides AN. Role of venous elasticity in the development of varicose veins. *Br J Surg* 1989;76(6):577-80.
3. Travers JP, Brookes CE, Evans J, Baker DM, Kent C, Makin GS, *et al.* Assessment of wall structure and composition of varicose veins with reference to collagen, elastin and smooth muscle content. *Eur J Vasc Endovasc Surg* 1996;11(2):230-7.
4. Wali MA, Eid RA. Changes of elastic and collagen fibers in varicose veins. *Int Angiol* 2002;21(4):337-43.
5. Jacob MP, Badier-Commander C, Fontaine V, Benazzoug Y, Feldman L, Michel JB. Extracellular matrix remodeling in the vascular wall. *Pathol Biol (Paris)* 2001;49(4):326-32.
6. Eberhardt RT, Raffetto JD. Chronic venous insufficiency. *Circulation* 2005;111(18):2398-409.
7. Tassiopoulos AK, Goltis E, Oh DS, Labropoulos N. Current concepts in chronic venous ulceration. *Eur J Vasc Endovasc Surg* 2000;20(3):227-32.

8. Morano JU, Raju S. Chronic venous insufficiency: assessment with descending venography. *Radiology* 1990;174(2):441-4.
9. Plate G, Brudin L, Eklof B, Jensen R, Ohlin P. Congenital vein valve aplasia. *World J Surg* 1986;10(6):929-34.
10. Gupta A, McCarthy S. Pelvic varices as a cause for pelvic pain: MRI appearance. *Magn Reson Imaging* 1994;12(4):679-81.
11. Lechter A, Alvarez A, Lopez G. Pelvic varices and gonadal veins. *Phlebology* 1987;2:181-8.
12. Cordts PR, Eclavea A, Buckley PJ, DeMaiores CA, Cockerill ML, Yeager TD. Pelvic congestion syndrome: early clinical results after transcatheter ovarian vein embolization. *J Vasc Surg* 1998;28(5):862-8.
13. Scultetus AH, Villavicencio JL, Gillespie DL, Kao TC, Rich NM. The pelvic venous syndromes: analysis of our experience with 57 patients. *J Vasc Surg* 2002;36(5):881-8.
14. Killewich LA, Bedford GR, Beach KW, Strandness DE, Jr. Spontaneous lysis of deep venous thrombi: rate and outcome. *J Vasc Surg* 1989;9(1):89-97.
15. Markel A, Manzo RA, Bergelin RO, Strandness DE, Jr. Valvular reflux after deep vein thrombosis: incidence and time of occurrence. *J Vasc Surg* 1992;15(2):377-82; discussion 383-4.
16. O'Shaughnessy AM, Fitzgerald DE. Natural history of proximal deep vein thrombosis assessed by duplex ultrasound. *Int Angiol* 1997;16(1):45-9.
17. Elsharawy M, Elzayat E. Early results of thrombolysis vs anticoagulation in iliofemoral venous thrombosis. A randomised clinical trial. *Eur J Vasc Endovasc Surg* 2002;24(3):209-14.
18. Saha P, Humphries J, Modarai B, Mattock K, Waltham M, Evans CE, *et al.* Leukocytes and the natural history of deep vein thrombosis: current concepts and future directions. *Arterioscler Thromb Vasc Biol* 2011;31(3):506-12.
19. Wakefield TW, Myers DD, Henke PK. Mechanisms of venous thrombosis and resolution. *Arterioscler Thromb Vasc Biol* 2008;28(3):387-91.
20. May R, Thurner J. The cause of the predominantly sinistral occurrence of thrombosis of the pelvic veins. *Angiology* 1957;8(5):419-27.
21. Cockett FB, Thomas ML. The iliac compression syndrome. *Br J Surg* 1965;52(10):816-21.
22. Gullmo A. The strain obstruction syndrome of the femoral vein. *Acta Radiol* 1957;47(2):119-37.
23. Browse NL, Burnand KG, Thomas ML. Diseases of the veins. Pathology, Diagnosis and Treatment. London, UK.: Hodder and Stoughton, 1988.
24. Neglen P, Thrasher TL, Raju S. Venous outflow obstruction: An underestimated contributor to chronic venous disease. *J Vasc Surg* 2003;38(5):879-85.
25. Gloviczki P, Stanson AW, Stickler GB, Johnson CM, Toomey BJ, Meland NB, *et al.* Klippel-Trenaunay syndrome: the risks and benefits of vascular interventions. *Surgery* 1991;110(3):469-79.
26. Bates DO, Curry FE. Vascular endothelial growth factor increases hydraulic conductivity of isolated perfused microvessels. *Am J Physiol* 1996;271(6 Pt 2):H2520-8.
27. Bollinger A, Leu AJ, Hoffmann U, Franzeck UK. Microvascular changes in venous disease: an update. *Angiology* 1997;48(1):27-32.
28. Mortimer PS. Evaluation of lymphatic function: abnormal lymph drainage in venous disease. *Int Angiol* 1995;14(3 Suppl 1):32-5.
29. Partsch H, Mostbeck A. Involvement of the lymphatic system in post-thrombotic syndrome. *Wien Med Wochenschr* 1994;144(10-11):210-3.
30. Johnson BF, Manzo RA, Bergelin RO, Strandness DE, Jr. Relationship between changes in the deep venous system and the development of the postthrombotic syndrome after an acute episode of lower limb deep vein thrombosis: a one- to six-year follow-up. *J Vasc Surg* 1995;21(2):307-12; discussion 313.
31. Strandness DE, Jr., Langlois Y, Cramer M, Randlett A, Thiele BL. Long-term sequelae of acute venous thrombosis. *J Am Med Assoc* 1983;250(10):1289-92.
32. Lindner DJ, Edwards JM, Phinney ES, Taylor LM, Jr., Porter JM. Long-term hemodynamic and clinical sequelae of lower extremity deep vein thrombosis. *J Vasc Surg* 1986;4(5):436-42.

33. Norris CS, Darrow JM. Hemodynamic indicators of postthrombotic sequelae. *Arch Surg* 1986;121(7):765-8.
34. Akesson H, Brudin L, Dahlstrom JA, Eklof B, Ohlin P, Plate G. Venous function assessed during a 5 year period after acute ilio-femoral venous thrombosis treated with anticoagulation. *Eur J Vasc Surg* 1990;4(1):43-8.
35. Heldal M, Seem E, Sandset PM, Abildgaard U. Deep vein thrombosis: a 7-year follow-up study. *J Intern Med* 1993;234(1):71-5.
36. Milne AA, Stonebridge PA, Bradbury AW, Ruckley CV. Venous function and clinical outcome following deep vein thrombosis. *Br J Surg* 1994;81(6):847-9.
37. Milne AA, Ruckley CV. The clinical course of patients following extensive deep venous thrombosis. *Eur J Vasc Surg* 1994;8(1):56-9.
38. van Ramshorst B, van Bemmelen PS, Hoenefeld H, Eikelboom BC. The development of valvular incompetence after deep vein thrombosis: a follow-up study with duplex scanning. *J Vasc Surg* 1994;19(6):1059-66.
39. van Haarst EP, Liasis N, van Ramshorst B, Moll FL. The development of valvular incompetence after deep vein thrombosis: a 7 year follow-up study with duplex scanning. *Eur J Vasc Endovasc Surg* 1996;12(3):295-9.
40. Labropoulos N, Leon M, Nicolaides AN, Sowade O, Volteas N, Ortega F, *et al.* Venous reflux in patients with previous deep venous thrombosis: correlation with ulceration and other symptoms. *J Vasc Surg* 1994;20(1):20-6.
41. Bradbury AW, MacKenzie RK, Burns P, Fegan C. Thrombophilia and chronic venous ulceration. *Eur J Vasc Endovasc Surg* 2002;24(2):97-104.
42. Prandoni P, Lensing AW, Cogo A, Cuppini S, Villalta S, Carta M, *et al.* The long-term clinical course of acute deep venous thrombosis. *Ann Intern Med* 1996;125(1):1-7.
43. Mackenzie RK, Ludlam CA, Ruckley CV, Allan PL, Burns P, Bradbury AW. The prevalence of thrombophilia in patients with chronic venous leg ulceration. *J Vasc Surg* 2002;35(4):718-22.
44. Sam RC, Burns PJ, Hobbs SD, Marshall T, Wilkink AB, Silverman SH, *et al.* The prevalence of hyperhomocysteinemia, methylene tetrahydrofolate reductase C677T mutation, and vitamin B12 and folate deficiency in patients with chronic venous insufficiency. *J Vasc Surg* 2003;38(5):904-8.
45. Brandjes DP, Buller HR, Heijboer H, Huisman MV, de Rijk M, Jagt H, *et al.* Randomised trial of effect of compression stockings in patients with symptomatic proximal-vein thrombosis. *Lancet* 1997;349(9054):759-62.
46. Kahn SR. The post thrombotic syndrome. *Thromb Res* 2011;127 Suppl 3:S89-92.
47. Shiman MI, Pieper B, Templin TN, Birk TJ, Patel AR, Kirsner RS. Venous ulcers: A reappraisal analyzing the effects of neuropathy, muscle involvement, and range of motion upon gait and calf muscle function. *Wound Repair Regen* 2009;17(2):147-52.
48. Davies JA, Bull RH, Farrelly IJ, Wakelin MJ. A home-based exercise programme improves ankle range of motion in long-term venous ulcer patients. *Phlebology* 2007;22(2):86-9.
49. Danielsson G, Eklof B, Grandinetti A, Kistner RL. The influence of obesity on chronic venous disease. *Vasc Endovascular Surg* 2002;36(4):271-6.
50. Trendelenburg F. Über die Unterbindung der V. saphena magna bei Unterschenkelvarizen. *Beitr Klin Chir* 1891;7:195-210.
51. Bjordal R. Simultaneous pressure and flow recordings in varicose veins of the lower extremity. A haemodynamic study of venous dysfunction. *Acta Chir Scand* 1970;136(4):309-17.
52. Al-Mulhim AS, El-Hoseiny H, Al-Mulhim FM, Bayameen O, Sami MM, Abdulaziz K, *et al.* Surgical correction of main stem reflux in the superficial venous system: does it improve the blood flow of incompetent perforating veins? *World J Surg* 2003;27(7):793-6.
53. Darke SG, Penfold C. Venous ulceration and saphenous ligation. *Eur J Vasc Surg* 1992;6(1):4-9.
54. Lees TA, Lambert D. Patterns of venous reflux in limbs with skin changes associated with chronic venous insufficiency. *Br J Surg* 1993;80(6):725-8.
55. Myers KA, Ziegenbein RW, Zeng GH, Matthews PG. Duplex ultrasonography scanning for chronic venous disease: patterns of venous reflux. *J Vasc Surg* 1995;21(4):605-12.
56. Christopoulos D, Nicolaides AN, Szendro G. Venous reflux: quantification and correlation with the clinical severity of chronic venous disease. *Br J Surg* 1988;75(4):352-6.
57. Delis KT, Ibegbuna V, Nicolaides AN, Lauro A, Hafez H. Prevalence and distribution of incompetent perforating veins in chronic venous insufficiency. *J Vasc Surg* 1998;28(5):815-25.
58. Zukowski AJ, Nicolaides AN, Szendro G, Irvine A, Lewis R, Malouf GM, *et al.* Haemodynamic significance of incompetent calf perforating veins. *Br J Surg* 1991;78(5):625-9.
59. Stuart WP, Adam DJ, Allan PL, Ruckley CV, Bradbury AW. The relationship between the number, competence, and diameter of medial calf perforating veins and the clinical status in healthy subjects and patients with lower-limb venous disease. *J Vasc Surg* 2000;32(1):138-43.
60. Stuart WP, Lee AJ, Allan PL, Ruckley CV, Bradbury AW. Most incompetent calf perforating veins are found in association with superficial venous reflux. *J Vasc Surg* 2001;34(5):774-8.
61. Delis KT, Husmann M, Kalodiki E, Wolfe JH, Nicolaides AN. In situ hemodynamics of perforating veins in chronic venous insufficiency. *J Vasc Surg* 2001;33(4):773-82.
62. Labropoulos N, Tiongson J, Pryor L, Tassiopoulos AK, Kang SS, Mansour MA, *et al.* Nonsaphenous superficial vein reflux. *J Vasc Surg* 2001;34(5):872-7.
63. Sansilvestri-Morel P, Rupin A, Jaisson S, Fabiani JN, Verbeuren TJ, Vanhoutte PM. Synthesis of collagen is dysregulated in cultured fibroblasts derived from skin of subjects with varicose veins as it is in venous smooth muscle cells. *Circulation* 2002;106(4):479-83.
64. Bergan JJ, Schmid-Schonbein GW, Takase S. Therapeutic approach to chronic venous insufficiency and its complications: place of Daflon 500 mg. *Angiology* 2001;52 Suppl 1:S43-7.
65. Michiels C, Bouaziz N, Remacle J. Role of the endothelium and blood stasis in the appearance of varicose veins. *Int Angiol* 2002;21(1):1-8.
66. Weber C. Novel mechanistic concepts for the control of leukocyte transmigration: specialization of integrins, chemokines, and junctional molecules. *J Mol Med* 2003;81(1):4-19.
67. Bergan JJ, Schmid-Schonbein GW, Smith PD, Nicolaides AN, Boisseau MR, Eklof B. Chronic venous disease. *N Engl J Med* 2006;355(5):488-98.
68. Ono T, Bergan JJ, Schmid-Schonbein GW, Takase S. Monocyte infiltration into venous valves. *J Vasc Surg* 1998;27(1):158-66.
69. Takase S, Schmid-Schonbein G, Bergan JJ. Leukocyte activation in patients with venous insufficiency. *J Vasc Surg* 1999;30(1):148-56.
70. Takase S, Bergan JJ, Schmid-Schonbein G. Expression of adhesion molecules and cytokines on saphenous veins in chronic venous insufficiency. *Ann Vasc Surg* 2000;14(5):427-35.
71. Badier-Commander C, Verbeuren T, Lebard C, Michel JB, Jacob MP. Increased TIMP/MMP ratio in varicose veins: a possible explanation for extracellular matrix accumulation. *J Pathol* 2000;192(1):105-12.
72. Leu AJ, Leu HJ, Franzeck UK, Bollinger A. Microvascular changes in chronic venous insufficiency--a review. *Cardiovasc Surg* 1995;3(3):237-45.
73. Gemmati D, Federici F, Catozzi L, Giancesini S, Tacconi G, Scapoli GL, *et al.* DNA-array of gene variants in venous leg ulcers: detection of prognostic indicators. *J Vasc Surg* 2009;50(6):1444-51.
74. Muto A, Model L, Ziegler K, Eghbalieh SD, Dardik A. Mechanisms of vein graft adaptation to the arterial circulation: insights into the neointimal algorithm and management strategies. *Circ J* 2010;74(8):1501-12.
75. Hwang M, Berceci SA, Garbey M, Kim NH, Tran-Son-Tay R. The dynamics of vein graft remodeling induced by hemodynamic forces: a mathematical model. *Biomech Model Mechanobiol* 2012;11(3-4):411-23.
76. Lattimer CR, Azzam M, Kalodiki E, Makris GC, Geroulakos G. Saphenous pulsation on duplex may be a marker of severe chronic superficial venous insufficiency. *J Vasc Surg* 2012;56(5):1338-43.
77. Badier-Commander C, Couvelard A, Henin D, Verbeuren T, Michel JB, Jacob MP. Smooth muscle cell modulation and cytokine overproduction in varicose veins. An in situ study. *J Pathol* 2001;193(3):398-407.

78. Kockx MM, Knaepen MW, Bortier HE, Cromheeke KM, Bouterin-Falson O, Finet M. Vascular remodeling in varicose veins. *Angiology* 1998;49(11):871-7.
79. Xiao Y, Huang Z, Yin H, Lin Y, Wang S. *In vitro* differences between smooth muscle cells derived from varicose veins and normal veins. *J Vasc Surg* 2009;50(5):1149-54.
80. Anwar MA, Shalhoub J, Lim CS, Gohel MS, Davies AH. The effect of pressure-induced mechanical stretch on vascular wall differential gene expression. *J Vasc Res* 2012;49(6):463-78.
81. Cario-Toumaniantz C, Boularan C, Schurgers LJ, Heymann MF, Le Cunff M, Leger J, *et al.* Identification of differentially expressed genes in human varicose veins: involvement of matrix gla protein in extracellular matrix remodeling. *J Vasc Res* 2007;44(6):444-59.
82. Geroulakos G, Nicolaides A. Venous tone evaluation by elastic modulus and therapeutic implications. *Int Angiol* 1995;14(3 Suppl 1):14-7.
83. Lattimer CR, Kalodiki E, Azzam M, Geroulakos G. Varicose veins and severity of chronic venous disorder. *Acta Phlebologica* 2012;13(2):93-9.
84. Cooley BC, Chen CY, Hess R, Schmeling G. Incomplete resolution of deep vein thrombosis under reduced flow conditions. *Thromb Res* 2012;131(1):55-8.
85. Kierkegaard A, Norgren L, Olsson CG, Castenfors J, Persson G, Persson S. Incidence of deep vein thrombosis in bedridden non-surgical patients. *Acta Med Scand* 1987;222(5):409-14.
86. Puggioni A, Kistner RL, Eklof B, Lurie F. Surgical disobliteration of postthrombotic deep veins--endophlebectomy--is feasible. *J Vasc Surg* 2004;39(5):1048-52; discussion 52.
87. Lattimer CR, Kalodiki E, Hoppensteadt D, Chaudhry Z, Fareed J, Nicolaides AN, *et al.* Endogenous markers of thrombogenesis are significantly increased in patients with varicose veins. 12th Annual Meeting European Venous Forum, 30 June - 3 July, Slovenia 2011.
88. Henke PK, Mitsuya M, Luke CE, Elffline MA, Baldwin JF, Deatrck KB, *et al.* Toll-like receptor 9 signaling is critical for early experimental deep vein thrombosis resolution. *Arterioscler Thromb Vasc Biol* 2011;31(1):43-9.
89. Ojdana D, Safiejko K, Lipska A, Sacha P, Wiczorek P, Radziwon P, *et al.* The inflammatory reaction during chronic venous disease of lower limbs. *Folia Histochem Cytobiol* 2009;47(2):185-9.
90. Baldwin JF, Sood V, Elffline MA, Luke CE, Dewyer NA, Diaz JA, *et al.* The role of urokinase plasminogen activator and plasmin activator inhibitor-1 on vein wall remodeling in experimental deep vein thrombosis. *J Vasc Surg* 2012;56(4):1089-97.
91. Deatrck KB, Elffline M, Baker N, Luke CE, Blackburn S, Stabler C, *et al.* Postthrombotic vein wall remodeling: preliminary observations. *J Vasc Surg* 2011;53(1):139-46.
92. Dewyer NA, Sood V, Lynch EM, Luke CE, Upchurch GR, Jr., Wakefield TW, *et al.* Plasmin inhibition increases MMP-9 activity and decreases vein wall stiffness during venous thrombosis resolution. *J Surg Res* 2007;142(2):357-63.
93. Henke PK, Varma MR, Deatrck KB, Dewyer NA, Lynch EM, Moore AJ, *et al.* Neutrophils modulate post-thrombotic vein wall remodeling but not thrombus neovascularization. *Thromb Haemost* 2006;95(2):272-81.
94. Pollack AA, Taylor BE, *et al.* The effect of exercise and body position on the venous pressure at the ankle in patients having venous valvular defects. *J Clin Invest* 1949;28(3):559-63.
95. Pollack AA, Wood EH. Venous pressure in the saphenous vein at the ankle in man during exercise and changes in posture. *J Appl Physiol* 1949;1(9):649-62.
96. Abramowitz HB, Queral LA, Finn WR, Nora PF, Jr., Peterson LK, Bergan JJ, *et al.* The use of photoplethysmography in the assessment of venous insufficiency: a comparison to venous pressure measurements. *Surgery* 1979;86(3):434-41.
97. Nicolaides AN, Miles C. Photoplethysmography in the assessment of venous insufficiency. *J Vasc Surg* 1987;5(3):405-12.
98. Nachbur B. Measurement of peripheral venous pressure: a method for the determination of venous functional capacity of the lower extremities. *Zentralbl Phlebol* 1971;10(4):224-78.
99. Kriessmann A. Peripheral phlebodynamometry. Basis, technics, capabilities. *Vasa Suppl* 1975;4:1-35.
100. Partsch H. *Simultanendruckmessung und phlebographie am fuss.* In May RK, A., ed. *Periphere Venendruckmessung.* Stuttgart, Germany: Georg Thieme Verlag, 1978. pp. 147-56.
101. de Marees H, Wuppermann T, Zschege C. Functional testing of the peripheral venous system by means of peripheral circulatory measurements. *Vasa* 1978;7(3):282-90.
102. Nicolaides AN, Zukowski AJ. The value of dynamic venous pressure measurements. *World J Surg* 1986;10(6):919-24.
103. Reeder SW, Wolff O, Partsch H, Nicolaides AN, Mosti G, Cornu-Thenard A, *et al.* Expert consensus document on direct ambulatory venous pressure measurement. *Int Angiol* 2013;32(5):453-8.
104. Warren R, White EA, Belcher CD. Venous pressures in the saphenous system in normal, varicose, and postphlebotic extremities; alterations following femoral vein ligation. *Surgery* 1949;26(3):435-45.
105. Ludbrook J. Valvular Defect in Primary Varicose Veins: Cause or Effect? *Lancet* 1963;2(7321):1289-92.
106. Kuiper JP. Venous pressure determination (direct method). *Dermatologica* 1966;132(2):206-17.
107. Nicolaides AN, Sumner DS. *Investigations of Patients with Deep Vein Thrombosis and Chronic Venous Insufficiency.* London: Med-Orion 1991.
108. Arnoldi CC. Venous pressure in the leg of healthy human subjects at rest and during muscular exercise in the nearly erect position. *Acta Chir Scand* 1965;130(6):570-83.
109. Arnoldi CC. Venous pressure in patients with valvular incompetence of the veins of the lower limb. *Acta Chir Scand* 1966;132:628-45.
110. Hosoi Y, Zukowski A, Kakkos SK, Nicolaides AN. Ambulatory venous pressure measurements: new parameters derived from a mathematical hemodynamic model. *J Vasc Surg* 2002;36(1):137-42.
111. Papadakis KG, Christopoulos D, Hobbs JT, Nicolaides AN. Descending phlebography in patients with venous ulceration: hemodynamic implications. *Int Angiol* 2015;(in press).
112. Herman RJ, Neiman HL, Yao JS, Egan TJ, Bergan JJ, Malave SR. Descending venography: a method of evaluating lower extremity venous valvular function. *Radiology* 1980;137(1 Pt 1):63-9.
113. Bjordal RI. Pressure patterns in the saphenous system in patients with venous leg ulcers. The proximal saphenous occlusion test as a guide to diagnosis, therapy and prognosis. *Acta Chir Scand* 1971;137(6):495-501.
114. Kriessmann A. Ambulatory venous pressure measurements. In Nicolaides AN, J.S.T., ed. *Investigation of Vascular Disorders.* New York: Churchill Livingstone, 1981.
115. Burnand KG, Whimster I, Clemenson G, Thomas ML, Browse NL. The relationship between the number of capillaries in the skin of the venous ulcer-bearing area of the lower leg and the fall in foot vein pressure during exercise. *Br J Surg* 1981;68(5):297-300.
116. Shull KC, Nicolaides AN, Fernandes e Fernandes J, Miles C, Horner J, Needham T, *et al.* Significance of popliteal reflux in relation to ambulatory venous pressure and ulceration. *Arch Surg* 1979;114(11):1304-6.
117. Negus D, Friedgood A. The effective management of venous ulceration. *Br J Surg* 1983;70(10):623-7.
118. Browse NL, Burnand KG. The cause of venous ulceration. *Lancet* 1982;2(8292):243-5.
119. Sumner DS. Venous dynamics--varicosities. *Clin Obstet Gynecol* 1981;24(3):743-60.
120. Burnand KG, O'Donnell TF, Jr., Thomas ML, Browse NL. The relative importance of incompetent communicating veins in the production of varicose veins and venous ulcers. *Surgery* 1977;82(1):9-14.
121. Wilkinson GE, Jr., Maclaren IF. Long term review of procedures for venous perforator insufficiency. *Surg Gynecol Obstet* 1986;163(2):117-20.
122. Partsch H, Gisel I. Functional indications for stripping in the treatment of varicose veins (author's transl). *Wien Klin Wochenschr* 1977;89(18):627-32.
123. Partsch H. Venous pressure measurement in phlebology. *Hautarzt* 1981;32(2):53-8.
124. Labropoulos N, Giannoukas AD, Nicolaides AN, Veller M, Leon M, Volteas N. The role of venous reflux and calf muscle pump function in nonthrombotic chronic venous insufficiency. Correlation with severity of signs and symptoms. *Arch Surg* 1996;131(4):403-6.

125. Ibegbuna V, Delis KT, Nicolaides AN. Haemodynamic and clinical impact of superficial, deep and perforator vein incompetence. *Eur J Vasc Endovasc Surg* 2006;31(5):535-41.
126. Danielsson G, Eklof B, Kistner RL. Association of venous volume and diameter of incompetent perforator veins in the lower limb-implications for perforator vein surgery. *Eur J Vasc Endovasc Surg* 2005;30(6):670-3.
127. Lattimer CR, Mendoza E. Superficial venous reflux duration and cessation with two concurrent duplex probes. *JVS: Venous and Lymph Dis* 2015;3(1):154-160.
128. Lattimer CR, Azzam M, Kalodiki E, Geroulakos G. Quantifying saphenous recirculation in patients with primary lower extremity venous reflux. *JVS: Venous and Lymph Dis* 2016;4(Published online: November 24 2015- In Press Corrected Proof).
129. Bjordal RI. Circulation patterns in incompetent perforating veins in the calf and in the saphenous system in primary varicose veins. *Acta Chir Scand* 1972;138(3):251-61.
130. Bjordal RI. Blood circulation in varicose veins of the lower extremities. *Angiology* 1972;23(3):163-73.
131. Folse R, Alexander RH. Directional flow detection for localizing venous valvular incompetence. *Surgery* 1970;67(1):114-21.
132. Kianifard B, Holdstock J, Allen C, Smith C, Price B, Whiteley MS. Randomized clinical trial of the effect of adding subfascial endoscopic perforator surgery to standard great saphenous vein stripping. *Br J Surg* 2007;94(9):1075-80.
133. Nelzen O, Fransson I. Early results from a randomized trial of saphenous surgery with or without subfascial endoscopic perforator surgery in patients with a venous ulcer. *Br J Surg* 2011;98(4):495-500.
134. Nelzen O, Fransson I. True long-term healing and recurrence of venous leg ulcers following SEPS combined with superficial venous surgery: a prospective study. *Eur J Vasc Endovasc Surg* 2007;34(5):605-12.
135. van Bemmelen PS, Bedford G, Beach K, Strandness DE. Quantitative segmental evaluation of venous valvular reflux with duplex ultrasound scanning. *J Vasc Surg* 1989;10(4):425-31.
136. Labropoulos N, Leon M, Nicolaides AN, Giannoukas AD, Volteas N, Chan P. Superficial venous insufficiency: correlation of anatomic extent of reflux with clinical symptoms and signs. *J Vasc Surg* 1994;20(6):953-8.
137. Neglen P, Egger JF, 3rd, Olivier J, Raju S. Hemodynamic and clinical impact of ultrasound-derived venous reflux parameters. *J Vasc Surg* 2004;40(2):303-10.
138. Yamaki T, Nozaki M, Fujiwara O, Yoshida E. Comparative evaluation of duplex-derived parameters in patients with chronic venous insufficiency: correlation with clinical manifestations. *J Am Coll Surg* 2002;195(6):822-30.
139. Yamaki T, Nozaki M, Sakurai H, Takeuchi M, Kono T, Soejima K. Quantification of venous reflux parameters using duplex scanning and air plethysmography. *Phlebology* 2007;22(1):20-8.
140. Vasdekis SN, Clarke GH, Nicolaides AN. Quantification of venous reflux by means of duplex scanning. *J Vasc Surg* 1989;10(6):670-7.
141. Navarro TP, Delis KT, Ribeiro AP. Clinical and hemodynamic significance of the greater saphenous vein diameter in chronic venous insufficiency. *Arch Surg* 2002;137(11):1233-7.
142. van Bemmelen PS, Mattos MA, Hodgson KJ, Barkmeier LD, Ramsey DE, Faught WE, *et al*. Does air plethysmography correlate with duplex scanning in patients with chronic venous insufficiency? *J Vasc Surg* 1993;18(5):796-807.
143. Mendoza E, Blattler W, Amsler F. Great saphenous vein diameter at the saphenofemoral junction and proximal thigh as parameters of venous disease class. *Eur J Vasc Endovasc Surg* 2013;45(1):76-83.
144. Theivacumar NS, Dellagrammaticas D, Mavor AI, Gough MJ. Endovenous laser ablation: does standard above-knee great saphenous vein ablation provide optimum results in patients with both above- and below-knee reflux? A randomized controlled trial. *J Vasc Surg* 2008;48(1):173-8.
145. Theivacumar NS, Darwood RJ, Dellegrammaticas D, Mavor AI, Gough MJ. The clinical significance of below-knee great saphenous vein reflux following endovenous laser ablation of above-knee great saphenous vein. *Phlebology* 2009;24(1):17-20.
146. Neglen P, Raju S. A rational approach to detection of significant reflux with duplex Doppler scanning and air plethysmography. *J Vasc Surg* 1993;17(3):590-5.
147. Burger HC, Horeman HW, Brakkee AJM. Comparison of some methods for measuring peripheral blood flow. *Phys Med Biol* 1959;4:168-75.
148. Barnes RW, Collicott PE, Mozersky DJ, Summer DS, Strandness DE, Jr. Noninvasive quantitation of maximum venous outflow in acute thrombophlebitis. *Surgery* 1972;72(6):971-9.
149. Thulesius O, Norgren L, Gjores JE. Foot-volumetry, a new method for objective assessment of edema and venous function. *Vasa* 1973;2(4):325-9.
150. Rosfors S, Persson LM, Blomgren L. Computerized venous strain-gauge plethysmography is a reliable method for measuring venous function. *Eur J Vasc Endovasc Surg* 2014;47(1):81-6.
151. Dahn I, Eiriksson E. Plethysmographic diagnosis of deep venous thrombosis of the leg. *Acta Chir Scand Suppl* 1968;398:33-42.
152. Hyman C, Winsor T. History of plethysmography. *J Cardiovasc Surg (Torino)* 1961;2:506-18.
153. Greenfield AD, Whitney RJ, Mowbray JF. Methods for the investigation of peripheral blood flow. *Br Med Bull* 1963;19:101-9.
154. Cramer M, Beach KW, Strandness DE. The detection of proximal deep vein thrombosis by strain gauge plethysmography through the use of an outflow/capacitance discriminant line. *Bruil* 1983;7:17-21.
155. Christopoulos DG, Nicolaides AN, Szendro G, Irvine AT, Bull ML, Eastcott HH. Air-plethysmography and the effect of elastic compression on venous hemodynamics of the leg. *J Vasc Surg* 1987;5(1):148-59.
156. Christopoulos D, Nicolaides AN. Noninvasive diagnosis and quantitation of popliteal reflux in the swollen and ulcerated leg. *J Cardiovasc Surg (Torino)* 1988;29(5):535-9.
157. Norgren L, Thulesius O. Pressure-volume characteristics of foot veins in normal cases and patients with venous insufficiency. *Blood Vessels* 1975;12(1):1-12.
158. Eiriksson E, Dahn I. Plethysmographic studies of venous distensibility in patients with varicose veins. *Acta Chir Scand Suppl* 1968;398:19-26.
159. Kidd BS, Lyons SM. The distensibility of the blood vessels of the human calf determined by graded venous congestion. *J Physiol* 1958;140(1):122-8.
160. Glover WE, Greenfield AD, Kidd BS, Whelan RF. The reactions of the capacity blood vessels of the human hand and forearm to vasoactive substances infused intra-arterially. *J Physiol* 1958;140(1):113-21.
161. Partsch H, Mostbeck A. Constriction of varicose veins and improvement of venous pumping by dihydroergotamine. *Vasa* 1985;14(1):74-80.
162. Sharpey-Schafer EP. Venous tone: effects of reflex changes, humoral agents and exercise. *Br Med Bull* 1963;19:145-8.
163. Goodrich SM, Wood JE. Peripheral Venous Distensibility and Velocity of Venous Blood Flow During Pregnancy or During Oral Contraceptive Therapy. *Am J Obstet Gynecol* 1964;90:740-4.
164. Forconi S, Guerrini M, Pecchi S, Cappelli R, Bruni F. Effect of HR (O-(beta-hydroxyethyl)-rutosides) on the impaired venous function of young females taking oral contraceptives. A strain gauge plethysmographic and clinical open controlled study. *Vasa* 1980;9(4):324-30.
165. Asbeutah AM, Riha AZ, Cameron JD, McGrath BP. Reproducibility of duplex ultrasonography and air plethysmography used for the evaluation of chronic venous insufficiency. *J Ultrasound Med* 2005;24(4):475-82.
166. Christopoulos D, Nicolaides AN, Cook A, Irvine A, Galloway JM, Wilkinson A. Pathogenesis of venous ulceration in relation to the calf muscle pump function. *Surgery* 1989;106(5):829-35.
167. Partsch H, Menzinger G, Mostbeck A. Inelastic leg compression is more effective to reduce deep venous refluxes than elastic bandages. *Dermatol Surg* 1999;25(9):695-700.
168. Christopoulos D, Nicolaides AN, Galloway JM, Wilkinson A. Objective noninvasive evaluation of venous surgical results. *J Vasc Surg* 1988;8(6):683-7.

169. Negus D, Cockett FB. Femoral vein pressures in post-phlebotic iliac vein obstruction. *Br J Surg* 1967;54(6):522-5.
170. Labropoulos N, Borge M, Pierce K, Pappas PJ. Criteria for defining significant central vein stenosis with duplex ultrasound. *J Vasc Surg* 2007;46(1):101-7.
171. Ibegbuna V. Haemodynamics in chronic venous disease. Vol. PhD Thesis. London: London University., 2002. pp. 221-235.
172. Kalodiki E, Nicolaides AN. Air-plethysmography for the detection of acute DVT; New criteria. *Vasc Surg* 1997;31(2):123-9.
173. Kalodiki E, Calahoras L, Delis KT, P. ZC, Nicolaides A. Air-plethysmography: The answer in detecting past deep venous thrombosis. *J Vasc Surg* 2001;33:715-20.
174. Bygdeman S, Aschberg S, Hindmarsh T. Venous plethysmography in the diagnosis of chronic venous insufficiency. *Acta Chir Scand* 1971;137(5):423-8.
175. Barnes RW, Ross EA, Strandness DE, Jr. Differentiation of primary from secondary varicose veins by Doppler ultrasound and strain gauge plethysmography. *Surg Gynecol Obstet* 1975;141(2):207-11.
176. Christopoulos D, Nicolaides AN, Duffy P, Georgiou I. Noninvasive diagnosis and quantification of outflow obstruction in venous disease. *J Cardiovasc Surg* 1989;30:72-3.
177. Lattimer CR, Kalodiki E, Mendoza E. Gravitational venous drainage is significantly faster in patients with varicose veins. *Phlebology* 2016. In Press.
178. Lattimer CR, Doucet S, Kalodiki E, Azzam M, Ibegbuna V, Geroulakos G. Increasing thigh compression pressure correlates with a reduction in the venous drainage index of air-plethysmography (2nd prize) 16th annual EVF meeting St Petersburg, 2015.
179. Lattimer CR, Mendoza E. Simultaneous Air-Plethysmography and Duplex Scanning on a Tilt-Table in Assessing Gravitational Venous Drainage. *JVS: Venous and Lymph Dis* 2016;4(1):151-2.
180. Lattimer CR, Kalodiki E, Azzam M, Schnatterbeck P, Geroulakos G. Gravitational Venous Drainage Improves Significantly After Iliac Venous Stenting but This May Result in Faster Venous Filling. *JVS: Venous and Lymph Dis* 2016;4(1):137-8.
181. Raju S. New approaches to the diagnosis and treatment of venous obstruction. *J Vasc Surg* 1986;4(1):42-54.
182. Nicolaides AN. Investigation of chronic venous insufficiency: A consensus statement (France, March 5-9, 1997). *Circulation* 2000;102(20):E126-63.
183. Labropoulos N, Volteas N, Leon M, Sowade O, Rulo A, Giannoukas AD, et al. The role of venous outflow obstruction in patients with chronic venous dysfunction. *Arch Surg* 1997;132(1):46-51.
184. Piulachs P, Vidal-Barraquer F. Pathogenic study of varicose veins. *Angiology* 1953;4(1):59-99.
185. Blalock A. Oxygen content of blood in patients with varicose veins. *Arch Surg* 1929;19:898-905.
186. Fontaine R. Remarks concerning venous thrombosis and its sequelae. *Surgery* 1957;41(1):6-25.
187. Haimovici H, Steinman C, Caplan LH. Role of arteriovenous anastomoses in vascular diseases of the lower extremity. *Ann Surg* 1966;164(6):990-1002.
188. Lindemayr W, Lofferer O, Mostbeck A, Partsch H. Arteriovenous shunts in primary varicosis? A critical essay. *Vasc Surg* 1972;6(1):9-13.
189. Hopkins NF, Spinks TJ, Rhodes CG, Ranicar AS, Jamieson CW. Positron emission tomography in venous ulceration and liposclerosis: study of regional tissue function. *Br Med J (Clin Res Ed)* 1983;286(6362):333-6.
190. Burnand KG, Whimster I, Naidoo A, Browse NL. Pericapillary fibrin in the ulcer-bearing skin of the leg: the cause of lipodermatosclerosis and venous ulceration. *Br Med J (Clin Res Ed)* 1982;285(6348):1071-2.
191. Franzcek UK, Bollinger A, Huch R, Huch A. Transcutaneous oxygen tension and capillary morphologic characteristics and density in patients with chronic venous incompetence. *Circulation* 1984;70(5):806-11.
192. Cheattle TR, Sarin S, Coleridge Smith PD, Scurr JH. The pathogenesis of skin damage in venous disease: a review. *Eur J Vasc Surg* 1991;5(2):115-23.
193. Belcaro G, Rulo A, Vasdekis S, Williams MA, Nicolaides AN. Combined evaluation of postphlebotic limbs by laser doppler flowmetry and transcutaneous PO2/PCO2 measurements. *Vasa* 1988;17(4):259-61.
194. Belcaro G, Nicolaides AN. Venous hypertension and the effect of therapeutic measures. In Belcaro G, Hoffmann U, Bollinger A, Nicolaides AN, eds. *Laser Doppler*. London, Los Angeles, Nicosia: Med-Orion Publishing Company, 1994.
195. Belcaro G, Grigg M, Rulo A, Nicolaides A. Blood flow in the perimalleolar skin in relation to posture in patients with venous hypertension. *Ann Vasc Surg* 1989;3(1):5-7.
196. Belcaro G, Christopoulos D, Nicolaides AN. Skin flow and swelling in post-phlebotic limbs. *Vasa* 1989;18(2):136-9.
197. Carpentier P, Magne JL, Sarrot-Reynaud F, Franco A. Chronic venous insufficiency and microcirculation. Physiopathologic and therapeutic reflections. *J Mal Vasc* 1987;12(3):280-4.
198. Perrin M, Ramelet AA. Pharmacological treatment of primary chronic venous disease: rationale, results and unanswered questions. *Eur J Vasc Endovasc Surg* 2011;41(1):117-25.
199. Levick JR. *An introduction to Cardiovascular Physiology*. Oxford, UK: Butterworth Heinemann Ltd, 1991.
200. Agren MS, Eaglstein WH, Ferguson MW, Harding KG, Moore K, Saarialho-Kere UK, et al. Causes and effects of the chronic inflammation in venous leg ulcers. *Acta Derm Venereol Suppl (Stockh)* 2000;210:3-17.
201. Schmid-Schonbein GW, Takase S, Bergan JJ. New advances in the understanding of the pathophysiology of chronic venous insufficiency. *Angiology* 2001;52 Suppl 1:S27-34.
202. Coleridge Smith PD, Thomas P, Scurr JH, Dormandy JA. Causes of venous ulceration: a new hypothesis. *Br Med J (Clin Res Ed)* 1988;296(6638):1726-7.
203. Nicolaides AN, Hussein MK, Szendro G, Christopoulos D, Vasdekis S, Clarke H. The relation of venous ulceration with ambulatory venous pressure measurements. *J Vasc Surg* 1993;17(2):414-9.
204. Gilje O, Kierland R, Baldes EJ. Capillary microscopy in the diagnosis of dermatologic diseases. *J Invest Dermatol* 1954;22(3):199-206.
205. Fagrell B. Local microcirculation in chronic venous incompetence and leg ulcers. *Vasc Surg* 1979;13:217-25.
206. Virgini-Magalhaes CE, Porto CL, Fernandes FF, Dorigo DM, Bottino DA, Bouskela E. Use of microcirculatory parameters to evaluate chronic venous insufficiency. *J Vasc Surg* 2006;43(5):1037-44.
207. Rovenska E, Rovensky J. Lymphatic vessels: structure and function. *Isr Med Assoc J* 2011;13(12):762-8.
208. Stanton AW, Patel HS, Levick JR, Mortimer PS. Increased dermal lymphatic density in the human leg compared with the forearm. *Microvasc Res* 1999;57(3):320-8.
209. Olszewski WL, Engeset A. Intrinsic contractility of prenodal lymph vessels and lymph flow in human leg. *Am J Physiol* 1980;239(6):H775-83.
210. Tanaka H, Zaima N, Sasaki T, Yamamoto N, Sano M, Konno H, et al. Loss of lymphatic vessels and regional lipid accumulation is associated with great saphenous vein incompetence. *J Vasc Surg* 2012;55(5):1440-8.
211. Levick JR, Michel CC. The effects of position and skin temperature on the capillary pressures in the fingers and toes. *J Physiol* 1978;274:97-109.
212. Henriksen O. Local reflex in microcirculation in human subcutaneous tissue. *Acta Physiol Scand* 1976;97(4):447-56.
213. Rayman G, Hassan A, Tooke JE. Blood flow in the skin of the foot related to posture in diabetes mellitus. *Br Med J (Clin Res Ed)* 1986;292(6513):87-90.
214. Tooke JE, Ostergren J, Fagrell B. Synchronous assessment of human skin microcirculation by laser Doppler flowmetry and dynamic capillaroscopy. *Int J Microcirc Clin Exp* 1983;2(4):277-84.
215. Belcaro G, Candiani C, Errichi BM, Marinucci R, Gaspari AL, Lania M, et al. A study of the capillary permeability in patients with venous hypertension by a new system: the vacuum suction chamber (VSC) device. *Panminerva Med* 1988;30(4):201-4.
216. Thulesius O. Capillary filtration under normal and pathological conditions. *Angiologia* 1973;10:198-213.

Chapter 4.

Effects of Different Types of Compression on Venous Hemodynamics and the Microcirculation

Pathophysiology of venous hemodynamic impairment relevant to compression therapy

As indicated in previous chapters, venous hydrostatic pressure in the leg varies according to the body position. In the supine position, it is less than 20 mm Hg while in the standing position it corresponds to the weight of the blood column between the right heart and the measuring point. The venous pressure in a dorsal foot vein in the standing immobile position is about 80-100 mm Hg depending on the height of the individual, in both healthy subjects and in patients with chronic venous disease (CVD).^{1, 2}

In a healthy subject, the peripheral muscle pump is able to reduce the venous standing pressure from approximately 80-100 mm Hg to less than 30 mmHg within a few steps.^{1, 2} In patients with venous disease due to chronic obstruction or valvular incompetence, venous return due to calf muscle pumping is impaired and the reduction in venous pressure with exercise is less so that the distal venous pressure remains at about 50 mmHg or higher. This is termed ambulatory venous hypertension^{3, 4} and results in a reduced ejection fraction from the leg.^{5, 6} Another important cause for ambulatory venous hypertension is dysfunction of the venous calf muscle due to muscle or joint dysfunction.

Accordingly, as CVD progresses, valvular function deteriorates with increasing venous reflux, residual venous volume increases during ambulation and calf muscle pump impairment finally develops resulting in a further increase of ambulatory venous hypertension.⁷ When deep venous obstruction is the main pathophysiological mechanism, calf muscle pump dysfunction can be even more severe, and the ambulatory venous hypertension is usually higher than in patients without obstruction.⁷

Compression materials, Pressure and Stiffness

Compression stockings, various bandages, adjustable velcro-band-devices and pumps are often used to treat CVD. Essential differences between these devices that determine their hemodynamic effect are the pressure and elastic properties exerted by the materials.

Compression Pressure

The pressure exerted by a device on an extremity corresponds to the “amount” of compression therapy.

The pressure produced by a stocking is determined by the commercial compression class of the hosiery in relation to the individual leg size which is measured by the prescriber and will rarely exceed a resting pressure of 40 mmHg.⁸ The pressure exerted by a bandage depends mainly on the tension with which the bandage is applied. Inelastic bandages and hook and loop (Velcro) band devices with short extension are usually applied under full stretch and produce initial resting pressures of 40 to 60 mmHg or more. These high initial pressures decrease almost immediately, mainly due to edema reduction.⁹ In contrast to inelastic bandages, which should be applied by trained staff requiring some skill and experience, hook and loop band devices can be put on and re-adjusted by the patients themselves.

Pumps (see Chapter 5) consist of one or several circumferential cuffs which are intermittently inflated with air at variable sequence and pressure and will be considered in this chapter only as models to compare with conventional compression systems.

Stiffness

Stiffness of a compression device is defined as the pressure increase induced by an increase in leg circumference of 1 cm⁸ and represents the relationship between its resting and working pressures. Based on stiffness, compression materials are differentiated into “elastic” and “inelastic”. An elastic or long-stretch material is extensible to more than 100%. An inelastic material may be “no-stretch” (e.g. zinc-paste) or short stretch with a maximal extensibility of less than 100%. By combining several materials over each other, the elastic property of the final composite bandage can change in an unpredictable manner. For instance, multi-component bandages consisting of different elastic components such as the so-called “four layer bandage” present a stiffness comparable to that of an inelastic material due to friction between the different layers.¹⁰ It is therefore a misconception to call such bandages “elastic”.¹¹ For this reason, the terms “elastic” and “inelastic” are most appropriately used for single bandages while, the elastic property of a multi-component bandage should rather be characterized by stiffness for which *in vivo* assessment has been proposed.¹²⁻¹⁴

Stiffness *in vivo* can be assessed by measuring the pressure under a compression product at the so called “B1 point” so as to calculate a “Static Stiffness Index (SSI)”, subtracting the supine from the standing pressure.^{12, 14} The B1 point is defined as the transition of the muscular into the tendinous part of the medial gastrocnemius muscle, the site for the biggest increase of leg circumference with dorsiflexion. A value of 10 was proposed as a cut-off point between elastic and inelastic materials,¹³ so that elastic material is characterized by a value lower than 10 and inelastic by a value higher than 10. Other parameters of stiffness that correlate with SSI are the maximal pressure achieved during exercise, pressure peaks and pressure amplitudes during walking (the difference between systolic and diastolic pressure); the latter parameters interplay in the dynamic stiffness index determination.¹⁵

Stiffness plays an important role in the performance of compression devices during standing and walking. With muscle contraction, an elastic material gives way to the muscle volume increase exerting a sub-bandage pressure which will be only slightly higher than the resting pressure. An inelastic stiff material does not give way to muscle expansion and the exerted pressure will rise significantly to the range able to overcome the intravenous pressure, thereby producing a significant vein narrowing or occlusion. These important differences concerning the pressure  inelastic and elastic materials are shown in Figure 4.1.

According to the law of Pascal, there is an equal increase of pressure at any point inside the system in a closed, non-yielding container when pressure increases by muscle activity. The energy created by functional activity is maintained so that already minimal muscle movement will create great variations in pressure.¹⁶

Due to its elastic properties, elastic material would need to be applied with very strong pressure at rest to achieve a similar high standing and working pressure and consequently would be painful and intolerable.¹⁷

Impact of Pressure and Stiffness on deranged Venous Hemodynamics

Different imaging methods such as phlebography, duplex ultrasound or magnetic resonance imaging (MRI) have been able to demonstrate narrowing of venous diameter by external compression which is a prerequisite

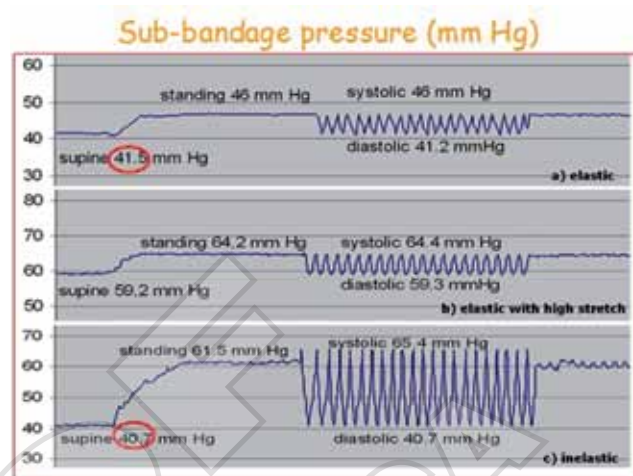

Figure 4.1.—Sub-bandage pressure tracings at the B1 point: a) elastic bandage (top), b) elastic bandage strongly applied (middle) and c) inelastic bandage (bottom). The resting pressure of a) and c) are approximately 40 mmHg. The pressure increase by standing up (=SSI) for a) is 4.5 mmHg and for c) 20.8 mmHg. During walking, the pressure amplitudes (“massaging effect”) are much higher under the inelastic than under the elastic bandages.

for its hemodynamic efficacy. The degree of narrowing depends on the body position and the compression pressure.

In the supine position, a pressure of about 20 mmHg is enough to narrow deep and superficial veins¹⁸⁻²² which causes a shift of blood volume towards the heart.²³ The resulting increase of the cardiac preload needs to be taken into consideration in patients with cardiac disease. At the same time, reduction of venous calibre leads to an increase of venous blood flow velocity which can be demonstrated by measuring the mean transit time to the groin after injecting radio-tracers into a dorsal foot vein^{24, 25} or by duplex ultrasound.²⁶⁻²⁹

In the upright position, pressures of 70-80 mm Hg are necessary to counteract the standing intravenous pressure and reduce venous diameter as clearly shown by phlebography,³⁰ duplex ultrasound^{21, 31} or MRI.^{22, 32, 33} A pressure of more than 60 mmHg is required to fully compress the femoral vein at thigh level in the upright position.²⁰ Surprisingly, it can be shown that in the prone or standing positions, compression may lead to more pronounced narrowing of deep than superficial veins, probably due to a shift of muscle compartments associated with higher subfascial pressures.^{22, 32, 33}

During walking, external compression created by an inelastic material produces pressure peaks with every

muscle systole which overcome the intravenous pressure and lead to intermittent narrowing of the veins, demonstrated by duplex ultrasound.²¹ Measuring pressures in a dorsal foot vein in patients with congenital absent valves (avalvulia) has shown that a thigh cuff inflated to 70 mmHg was able to cut down the elevated intravenous pressure peaks caused by reflux in veins during walking leading to a reduced mean ambulatory venous pressure.³⁴

Based on duplex ultrasound investigations in patients with superficial reflux, it has been speculated that coaptation of valvular cusps to restore valvular competence may be a basic mechanism of action from compression therapy in venous disease.³⁵ However, the important hemodynamic improvement of impaired muscle pumping even in avalvulia cannot be explained by reapproximating damaged valves by external compression, but is rather a result of intermittent venous narrowing during walking so as to create a kind of artificial valve mechanism that blocks reflux with every muscle contraction.³⁴ In patients with severe chronic venous reflux, measuring venous pressure in a dorsal foot vein while walking on a treadmill revealed similar results. By cutting down the systolic peaks of the intravenous pressure curve using inelastic compression bandages (resting pressure over 50 mmHg), the mean ambulatory venous pressures could be significantly reduced, and conversely this result could not be achieved using elastic stockings with much lower working pressures.³⁶

O'Donnell *et al.* were able to demonstrate significant reduction of maximal pressure peaks under 30-40 mmHg compression stockings in patients with post-thrombotic syndrome.³⁷

Abolition of venous reflux by strong and stiff compression in the post-thrombotic syndrome with deep venous reflux has also been shown in experiments in which global venous reflux was quantified by air-plethysmography.³⁸ In this study which involved 21 patients with leg ulcers and deep venous reflux, the efficacy of compression bandages of varying pressure and material (elastic, long-stretch *versus* inelastic, short-stretch bandages, four-layer bandages) was investigated. The initial median value of VFI without compression was 8.45 ml/sec. VV and VFI were significantly reduced by increasing external pressure, more strongly with inelastic than with elastic material. With a pressure of 25 mmHg, inelastic bandages diminished VFI to a median

of 3.25 ml/sec while the elastic material did not even approach this value with a pressure of 40 mmHg (4.25 ml/sec). Applying bandages of different material with the same pressure of 30 mmHg, the most intense reduction of VV and VFI was obtained by inelastic and by four-layer bandages. The effect on venous reflux was statistically significantly superior with inelastic compared to elastic material. With a pressure of more than 60 mmHg produced by inelastic bandages, even normal VFI-values corresponding to complete reflux abolition were achieved.³⁸

Similar results have been obtained in patients with superficial axial reflux using duplex ultrasound assessment, where increasing leg compression led to progressive reduction of great saphenous reflux. Similarly, sub-bandage pressures of more than 80 mmHg achieved by a non-elastic bandage in the standing position were able to abolish reflux completely.³⁹

Improvement of venous pumping function in patients with CVI has also been demonstrated by foot volumetry,⁴⁰⁻⁴² air plethysmography^{38, 43-45} and strain gauge plethysmography, measuring volume changes of the leg proximal to the compressed area.^{46, 47} When air plethysmography was used, below knee elastic compression (30 mmHg at the ankle) produced a 41% reduction in AVP, 28% reduction in VFI and 34% increase in EF.⁴³ Using strain gauge plethysmography, an increase of the ejection fraction of the calf pump by external compression under standardized exercise was demonstrated, with further improvements of increasing pressures between 20 and 60 mmHg. Elastic stockings led only to a moderate improvement of the deficient venous pumping function.⁴⁷ There was a significant correlation between ejection fraction and sub-bandage pressure during standing and walking and between ejection fraction and static stiffness index, demonstrating again the hemodynamic superiority of inelastic material.⁴⁷ This improvement of the pumping function by inelastic compression is likely to be based on two hemodynamic mechanisms: a) abolition of venous reflux and b) effective compression to strengthen the venous calf pump by distributing pressure peaks during each muscle contraction inside the closed system covered by a stiff bandage, following the law of Pascal.⁴⁸

High compression pressures over the calf were shown to be more effective than the conventional pressure gradient of compression devices in increasing the ejection fraction.^{49, 50}

Impact of Pressure and Stiffness on the arterial flow, the microcirculation and edema

Arterial flow

Measuring the ankle systolic arterial pressure by a sphygmomanometer placed on the distal leg and a CW-Doppler instrument gives important information on the local perfusion pressure. Values below 50 mmHg define critical ischemia⁵¹ and are a clear contraindication for sustained external compression exceeding this value. However, specially designed intermittent pneumatic compression pumps providing pressures of more than 100 mmHg for very short time periods followed by prolonged periods of pressure release with the patient in the sitting position proved to be beneficial in such patients.⁵²

Only few data are available concerning the influence of sustained compression on the arterial flow in patients with arterial occlusive disease. Magnetic resonance flowmetry was used in a group of healthy persons by Mayrovitz and Macdonald who reported an increase of pulsatile arterial flow under stiff, multi-component ankle-to-knee bandages applied with a pressure around 40 mmHg.⁵³ Top *et al.* showed that inelastic compression bandages did not reduce toe pressure.⁵⁴ These results are in accordance with the findings of Mosti *et al.*⁵⁵ who used laser Doppler flowmetry to show that in patients with mixed arterio-venous ulcers and an ankle/brachial pressure index between 0.5 and 0.8, there was no reduction but even an increase of flow under the bandage, as long as the exerted resting pressure of inelastic bandages did not exceed 40 mmHg. At the same time, the authors also demonstrated significant improvement of venous pumping function in these mixed ulcer patients.

Microcirculation

Various changes of the microcirculation have been described as a consequence of ambulatory venous hypertension (see chapter 3).^{56, 57}

A few experiments have shown beneficial effects of compression on the microcirculation.

In patients with chronic venous insufficiency, capillary microscopy revealed an increase in capillary density associated with a decrease in capillary diameter and pericapillary halo diameter after two weeks of compression.⁵⁸ Limb oxygenation measured by HbO₂ concen-

tration during walking exercise was shown to increase with stronger compression stockings reaching statistical significance with class III stockings only.⁵⁹ Abu Own *et al.* used laser Doppler to show increasing flow in normal and lipodermatosclerotic skin areas of the lower leg under a compression of up to 60 mmHg pressure in the sitting position.⁶⁰

The influence of compression on the physiologic veno-arteriolar reflex (VAR) induced by leg dependency demonstrated through ¹³³Xenon clearance⁶¹ and laser Doppler flowmetry^{62, 63} has also been described in patients with deep venous reflux. Three week use of below knee elastic stockings reduced resting red cell flux by 26% and improved VAR from 3% to 16% (normal value 37%).⁶² Patients with arterial occlusive disease show a reduced VAR which is conversely augmented under intermittent pneumatic compression.⁶³

Significant biochemical changes were reported with intermittent compression pumps which may be taken as a model for intermittent compression under inelastic bandages during walking.⁶⁴ Strain and shear on endothelial cells from intermittent compressive releases several anticoagulant, anti-inflammatory and vasodilating mediators from the endothelial cells.⁶⁴ Inflammatory cytokine levels in leg ulcer tissue were demonstrated to be reduced four weeks after compression therapy.⁶⁵ Compression results in reduction of the pro-inflammatory environment characterizing chronic venous ulcers by decreasing elevated matrix metalloproteinase (MMP) levels.⁶⁶

Edema

Following Starling's law, edema develops because of a complex interaction that involves the permeability of the capillary wall and hydrostatic and oncotic pressure gradients between blood vessels and tissues. Edema will form when net capillary filtration in the affected site exceeds lymphatic drainage.^{67, 68} Lymphatic drainage is a major factor in microcirculation homeostasis since nearly 100% of fluid is removed by the lymphatic circulation in peripheral tissues and not by venular reabsorption.⁶⁸

Studies using micro-lymphangiography and indirect lymphography have demonstrated that micro-lymphangiopathy is a typical feature of chronic venous insufficiency.^{56, 69} However, in spite of these overlaps, the

TABLE 4.1.—*Hemodynamic effects of compression therapy in chronic venous disease and levels of evidence.*

Hemodynamic effects of compression	Level of Evidence A. High quality B. Moderate quality C. Low or very low quality	Methodology
<i>Compression stockings < 20mmHg</i>		
Narrow superficial and deep veins in horizontal position. ^{22, 32}	A	MRI
increase venous flow velocity. ²⁴⁻²⁹	B	Radio-tracers, Doppler-duplex Ultrasound
Prevent leg swelling after long sitting/standing. ^{72, 73}	A	Volumetry
Reduce leg edema. ^{74, 75}	B	Volumetry, Bioimpedance Spectroscopy
<i>Compression stockings 20-40mmHg</i>		
May narrow deep but not superficial veins in standing position. ³³	B	MRI
Reduce leg edema. ⁷⁴⁻⁷⁶	A	Volumetry, Bioimpedance Spectroscopy
Reduce reflux. ^{38, 39, 77}	A	APG, Duplex
Improve venous pumping function. ^{35, 36, 40-45}	A	APG, foot volumetry, plethysmography
Reduce ambulatory venous hypertension. ³⁷	A	Intravenous pressure measurement
<i>Stiff bandages 20-40 mmHg</i>		
Reduce leg edema. ^{74, 75}	A	Volumetry, Bioimpedance Spectroscopy
Reduce reflux more than stockings. ^{38, 39, 44}	A	APG, Duplex
Improve venous pumping function more than stockings. ^{17, 36, 38, 44}	A	APG, foot volumetry, plethysmography,
Increase arterial flow. ^{53, 55}	A	Nuclear magnetic flowmetry, Laser Doppler,
<i>Stiff bandages 40-80 mmHg</i>		
Narrow superficial and deep veins in standing position. ²²	A	MRI
Intermittently narrow leg veins during muscle systole. ²¹	B	Duplex
Reduce leg edema. ⁷⁵	A	Volumetry, Bioimpedance Spectroscopy
Reduce reflux more than stockings. ^{38, 39, 44}	A	APG, Duplex
Improve venous pumping function more than stockings. ^{17, 38, 44}	A	APG, foot volumetry, plethysmography
Reduce ambulatory venous hypertension more than stockings. ³⁶	A	Venous pressure measurement

problem of lymphedema and its treatment by compression is outside the scope of this chapter and will therefore not be discussed in detail.

Compression counteracts edema especially by increasing tissue pressure⁷⁰, and is also able to normalize pathological patterns of damaged lymphatics in patients with skin changes due to CVI (72).⁷¹

Edema reduction by compression is clinically so evident that only relatively few studies have been interested in investigating a dose-response relationship measuring compression pressure and stiffness in relation to volume reduction. It has been demonstrated that low pressure stockings (less than 20 mmHg at the ankle) are able to prevent occupational edema in people whose work involves prolonged standing.^{72, 73} Furthermore, 20-30 mmHg pressures are effective for reducing chronic edema of the lower limbs which are significantly lower pressures than those needed to compress leg-vein in the upright position.^{74, 75}

Indications for compression devices based on hemodynamic evidence

Different compression devices have gained rational support for several clinical indications based on effects demonstrated by experiments. Table I summarizes levels of evidence concerning some hemodynamic effects that have been shown in clinical trials.

Compression hosiery

Elastic stockings are very effective for reducing vein diameter in the supine position so as to increase venous flow velocity (Grade A). This is the basis for a recommendation to use elastic stockings exerting 18 mm Hg at the ankle to prevent venous thromboembolism.⁷⁸

Compression stockings with a pressure of less than 20 mmHg are able to prevent edema after long sitting,

for example during long haul flights and after prolonged standing (occupational edema) (Grade A).⁷²

Elastic stockings with higher pressure are also effective in the upright position to reduce reflux and increase venous pumping function (Grade A). Two stockings may be superimposed, one over the other, to achieve higher compression pressures which are still manageable for patients to increase stiffness.⁷⁹ The basic stocking is worn overnight while the second stocking is applied over the first during daily activities when higher external pressure will be needed to counteract gravity.

Compression bandages with high stiffness

Inelastic materials are hemodynamically more effective than stockings, both to reduce reflux and increase venous pumping function (Grade A). Due to the higher standing pressure, inelastic devices with high stiffness can achieve this greater effect starting from a relatively low supine pressure of 20 mmHg.⁸⁰ Inelastic materials are frequently blamed for losing effectiveness over time due to pressure loss whereas elastic materials should lose pressure only slightly. In fact, Mosti *et al.* demonstrated that inelastic bandages applied for one week still showed improved venous pumping function after seven days despite significant pressure loss (Grade B).⁸¹ The stronger hemodynamic effect of stiff bandages is the reason why they are especially indicated for severe forms of CVI such as venous leg ulcers.

After interventions on varicose veins, compression of the venous lumen (“empty vein”) needs high pressure⁸² which may be variable according to the location of the treated vein. Compression stockings are too weak to significantly reduce superficial venous diameters in the upright position.^{21, 31} As demonstrated by MRI in the standing position, pressures of more than 60 mmHg are necessary to compress superficial veins on the thigh and lower leg (Grade A). If we want to achieve an “empty vein” after sclerotherapy or after endovenous thermal ablation then this can be realized only by very firm bandaging,^{22, 33} or by applying pads over the treated veins in addition to conventional compression. It has been demonstrated that special pads applied under a compression stocking may exert a local pressure of 60 mmHg and consequently a closure of the underlying saphenous vein in the thigh.^{22, 33, 82}

Adjustable Velcro band devices

These compression devices consist of short stretch textiles and may be assumed to produce hemodynamic effects comparable to those of inelastic bandages. Their hemodynamic superiority compared with elastic 30-40 mmHg stockings has been demonstrated by Spence *et al.*⁴⁴ The main advantage is the fact that after a short demonstration, they can be applied and re-adjusted by the patients themselves.

Conclusions

Most experimental studies on compression correspond to level 1 evidence (Grade A) and have proved that compression has positive effects on impaired venous hemodynamics in patients with CVD. This results in:

- narrowing of superficial and deep veins depending on body position and exerted pressure
- increase of venous blood velocity
- reduction or abolition of venous reflux
- improvement or normalization of venous pumping function, and consequently,
- reduction or normalization of ambulatory venous hypertension and improvement of the microcirculation, and reduction of edema

Compression is able to counteract the hemodynamic impairment of CVD if the exerted interface pressure is higher than the intravenous pressure. The ideal compression device should therefore exert a low resting pressure which is well tolerated at rest and during night time combined with a high standing and working pressure.

References

1. Meissner MH, Moneta G, Burnand K, Gloviczki P, Lohr JM, Lurie F, *et al.* The hemodynamics and diagnosis of venous disease. *J Vasc Surg* 2007;46 Suppl S:4S-24S.
2. Pollack AA, Wood EH. Venous pressure in the saphenous vein at the ankle in man during exercise and changes in posture. *J Appl Physiol* 1949;1(9):649-62.
3. Burnand KG, Wadoodi A. The physiology and hemodynamics of chronic venous insufficiency of the lower limb. . In Gloviczki P, ed. *Handbook of venous disorders Guidelines of the American Venous Forum*. London: Arnold, 2009. pp. 47-56.
4. Nicolaidis AN. Investigation of chronic venous insufficiency: A consensus statement (France, March 5-9, 1997). *Circulation* 2000;102(20):E126-63.
5. Kugler C, Strunk M, Rudofsky G. Venous pressure dynamics of the healthy human leg. Role of muscle activity, joint mobility and anthropometric factors. *J Vasc Res* 2001;38(1):20-9.

6. Hosoi Y, Zukowski A, Kakkos SK, Nicolaides AN. Ambulatory venous pressure measurements: new parameters derived from a mathematical hemodynamic model. *J Vasc Surg* 2002;36(1):137-42.
7. Welkie JF, Comerota AJ, Katz ML, Aldridge SC, Kerr RP, White JV. Hemodynamic deterioration in chronic venous disease. *J Vasc Surg* 1992;16(5):733-40.
8. CEN. <http://www.icc-compressionclub.com> - Under: References & links: read CEN doc.pdf. 2001.
9. Damstra RJ, Brouwer ER, Partsch H. Controlled, comparative study of relation between volume changes and interface pressure under short-stretch bandages in leg lymphedema patients. *Dermatol Surg* 2008;34(6):773-8; discussion 778-9.
10. Mosti G, Mattaliano V, Partsch H. Influence of different materials in multicomponent bandages on pressure and stiffness of the final bandage. *Dermatol Surg* 2008;34(5):631-9.
11. O'Meara S, Cullum NA, Nelson EA. Compression for venous leg ulcers. *Cochrane Database Syst Rev* 2009(1):CD000265.
12. Partsch H. The use of pressure change on standing as a surrogate measure of the stiffness of a compression bandage. *Eur J Vasc Endovasc Surg* 2005;30(4):415-21.
13. Partsch H, Clark M, Mosti G, Steinlechner E, Schuren J, Abel M, *et al.* Classification of compression bandages: practical aspects. *Dermatol Surg* 2008;34(5):600-9.
14. Partsch H. The static stiffness index: a simple method to assess the elastic property of compression material *in vivo*. *Dermatol Surg* 2005;31(6):625-30.
15. van der Wegen-Franken K, Tank B, Neumann M. Correlation between the static and dynamic stiffness indices of medical elastic compression stockings. *Dermatol Surg* 2008;34(11):1477-85.
16. Schuren J. Compression unraveled Thesis. Margreff Druck: University of Rotterdam, 2011.
17. Mosti G, Mattaliano V, Partsch H. Inelastic compression increases venous ejection fraction more than elastic bandages in patients with superficial venous reflux. *Phlebology* 2008;23(6):287-94.
18. Coleridge Smith PD, Hasty JH, Scurr JH. Deep vein thrombosis: effect of graduated compression stockings on distension of the deep veins of the calf. *Br J Surg* 1991;78(6):724-6.
19. Uhl JF. 3D multislice CT to demonstrate the effects of compression therapy. *Int Angiol* 2010;29(5):411-5.
20. Partsch H, Menzinger G, Borst-Krafek B, Groiss E. Does thigh compression improve venous hemodynamics in chronic venous insufficiency? *J Vasc Surg* 2002;36(5):948-52.
21. Partsch B, Partsch H. Calf compression pressure required to achieve venous closure from supine to standing positions. *J Vasc Surg* 2005;42(4):734-8.
22. Partsch H, Mosti G, Mosti F. Narrowing of leg veins under compression demonstrated by magnetic resonance imaging (MRI). *Int Angiol* 2010;29(5):408-10.
23. Mostbeck A, Partsch H, Peschl L. Alteration of blood volume distribution throughout the body resulting from physical and pharmacological interventions. *Vasa* 1977;6(2):137-42.
24. Meyerowitz BR, Nelson R. Measurement of the Velocity of Blood in Lower Limb Veins with and without Compression. *Surgery* 1964;56:481-6.
25. Partsch H, Kahn P. Venöse Strömungsbeschleunigung im Bein und Becken durch "AntiThrombosestrümpfe". *Klinikerzt* 1982;11:609-15.
26. Morris RJ, Woodcock JP. Evidence-based compression: prevention of stasis and deep vein thrombosis. *Ann Surg* 2004;239(2):162-71.
27. Norgren L, Austrell C, Nilsson L. The effect of graduated elastic compression stockings on femoral blood flow velocity during late pregnancy. *Vasa* 1995;24(3):282-5.
28. Jamieson R, Calderwood CJ, Greer IA. The effect of graduated compression stockings on blood velocity in the deep venous system of the lower limb in the postnatal period. *Bjog* 2007;114(10):1292-4.
29. Macklon NS, Greer IA. Technical note: compression stockings and posture: a comparative study of their effects on the proximal deep veins of the leg at rest. *Br J Radiol* 1995;68(809):515-8.
30. Partsch H. Compression therapy of the legs. A review. *J Dermatol Surg Oncol* 1991;17(10):799-805.
31. Lord RS, Hamilton D. Graduated compression stockings (20-30 mmHg) do not compress leg veins in the standing position. *ANZ J Surg* 2004;74(7):581-5.
32. Downie SP, Firmin DN, Wood NB, Thom SA, Hughes AD, Wolfe JN, *et al.* Role of MRI in investigating the effects of elastic compression stockings on the deformation of the superficial and deep veins in the lower leg. *J Magn Reson Imaging* 2007;26(1):80-5.
33. Partsch H, Mosti G, Uhl JF. Unexpected venous diameter reduction by compression stocking of deep, but not of superficial veins. *J Vasc Surg: Venous and Lym Dis* 2012;1(e3):7-9.
34. Partsch B, Mayer W, Partsch H. Improvement of ambulatory venous hypertension by narrowing of the femoral vein in congenital absence of venous valves. *Phlebology* 1992;7:101-4.
35. Sarin S, Scurr JH, Coleridge Smith PD. Mechanism of action of external compression on venous function. *Br J Surg* 1992;79(6):499-502.
36. Partsch H. Improving the venous pumping function in chronic venous insufficiency by compression as dependent on pressure and material. *Vasa* 1984;13(1):58-64.
37. O'Donnell TF, Jr., Rosenthal DA, Callow AD, Ledig BL. Effect of elastic compression on venous hemodynamics in postphlebotic limbs. *Jama* 1979;242(25):2766-8.
38. Partsch H, Menzinger G, Mostbeck A. Inelastic leg compression is more effective to reduce deep venous refluxes than elastic bandages. *Dermatol Surg* 1999;25(9):695-700.
39. Mosti G, Partsch H. Duplex scanning to evaluate the effect of compression on venous reflux. *Int Angiol* 2010;29(5):416-20.
40. Norgren L. Elastic compression stockings--an evaluation with foot volumetry, strain-gauge plethysmography and photoplethysmography. *Acta Chir Scand* 1988;154(9):505-7.
41. Partsch H. Do we need firm compression stockings exerting high pressure? *Vasa* 1984;13(1):52-7.
42. Gjores JE, Thulesius O. Compression treatment in venous insufficiency evaluated with foot volumetry. *Vasa* 1977;6(4):364-8.
43. Christopoulos D, Nicolaides AN, Belcaro G, Duffy P. The effect of elastic compression on calf muscle pump function. *Phlebology* 1990;5(2):13-19.
44. Spence RK, Cahall E. Inelastic *versus* elastic leg compression in chronic venous insufficiency: a comparison of limb size and venous hemodynamics. *J Vasc Surg* 1996;24(5):783-7.
45. Ibegbuna V, Delis KT, Nicolaides AN, Aina O. Effect of elastic compression stockings on venous hemodynamics during walking. *J Vasc Surg* 2003;37(2):420-5.
46. Poelkens F, Thijssen DH, Kersten B, Scheurwater H, van Laarhoven EW, Hopman MT. Counteracting venous stasis during acute lower leg immobilization. *Acta Physiol (Oxf)* 2006;186(2):111-8.
47. Mosti G, Partsch H. Measuring venous pumping function by strain-gauge plethysmography. *Int Angiol* 2010;29(5):421-5.
48. Schuren J, Mohr K. Pascal's law and the dynamics of compression therapy: a study on healthy volunteers. *Int Angiol* 2010;29(5):431-5.
49. Mosti G, Partsch H. Compression stockings with a negative pressure gradient have a more pronounced effect on venous pumping function than graduated elastic compression stockings. *Eur J Vasc Endovasc Surg* 2011;42(2):261-6.
50. Mosti G, Partsch H. High compression pressure over the calf is more effective than graduated compression in enhancing venous pump function. *Eur J Vasc Endovasc Surg* 2012;44(3):332-6.
51. Norgren L, Hiatt WR, Dormandy JA, Nehler MR, Harris KA, Fowkes FG. Inter-Society Consensus for the Management of Peripheral Arterial Disease (TASC II). *J Vasc Surg* 2007;45 Suppl S:S5-67.
52. Kavros SJ, Delis KT, Turner NS, Voll AE, Liedl DA, Gloviczki P, *et al.* Improving limb salvage in critical ischemia with intermittent pneumatic compression: a controlled study with 18-month follow-up. *J Vasc Surg* 2008;47(3):543-9.
53. Mayrovitz HN, Macdonald JM. Medical compression: effects on pulsatile leg blood flow. *Int Angiol* 2010;29(5):436-41.
54. Top S, Arveschoug AK, Fogh K. Do short-stretch bandages affect distal blood pressure in patients with mixed aetiology leg ulcers? *J Wound Care* 2009;18(10):439-42.

55. Mosti G, Iabichella ML, Partsch H. Compression therapy in mixed ulcers increases venous output and arterial perfusion. *J Vasc Surg* 2012;55(1):122-8.
56. Franzeck UK, Haselbach P, Speiser D, Bollinger A. Microangiopathy of cutaneous blood and lymphatic capillaries in chronic venous insufficiency (CVI). *Yale J Biol Med* 1993;66(1):37-46.
57. Junger M, Steins A, Hahn M, Hafner HM. Microcirculatory dysfunction in chronic venous insufficiency (CVI). *Microcirculation* 2000;7(6 Pt 2):S3-12.
58. Klyszcz T, Galler S, Steins A, Zuder D, Rassner G, Junger M. The effect of compression therapy on the microcirculation of the skin in patients with chronic venous insufficiency (CVI). *Hautarzt* 1997;48(11):806-11.
59. Agu O, Baker D, Seifalian AM. Effect of graduated compression stockings on limb oxygenation and venous function during exercise in patients with venous insufficiency. *Vascular* 2004;12(1):69-76.
60. Abu-Own A, Shami SK, Chittenden SJ, Farrah J, Scurr JH, Smith PD. Microangiopathy of the skin and the effect of leg compression in patients with chronic venous insufficiency. *J Vasc Surg* 1994;19(6):1074-83.
61. Nielsen HV. Effects of externally applied compression on blood flow in the human dependent leg. *Clin Physiol* 1983;3(2):131-40.
62. Belcaro G, Gaspari AL, Legnini M, Napolitano AM, Marelli C. Evaluation of the effects of elastic compression in patients with chronic venous hypertension by laser-Doppler flowmetry. *Acta Chir Belg* 1988;88(3):163-7.
63. Husmann M, Willenberg T, Keo HH, Spring S, Kalodiki E, Delis KT. Integrity of venoarteriolar reflex determines level of microvascular skin flow enhancement with intermittent pneumatic compression. *J Vasc Surg* 2008;48(6):1509-13.
64. Chen AH, Frangos SG, Kilaru S, Sumpio BE. Intermittent pneumatic compression devices -- physiological mechanisms of action. *Eur J Vasc Endovasc Surg* 2001;21(5):383-92.
65. Beidler SK, Douillet CD, Berndt DF, Keagy BA, Rich PB, Marston WA. Inflammatory cytokine levels in chronic venous insufficiency ulcer tissue before and after compression therapy. *J Vasc Surg* 2009;49(4):1013-20.
66. Beidler SK, Douillet CD, Berndt DF, Keagy BA, Rich PB, Marston WA. Multiplexed analysis of matrix metalloproteinases in leg ulcer tissue of patients with chronic venous insufficiency before and after compression therapy. *Wound Repair Regen* 2008;16(5):642-8.
67. Starling EH. On the absorption of fluids from the connective tissue spaces. *J Physiol* 1896;19:312.
68. Levick JR, Michel CC. Microvascular fluid exchange and the revised Starling principle. *Cardiovasc Res* 2010;87(2):198-210.
69. Bollinger A, Partsch H, Wolfe JHN. *The Initial Lymphatics*. Stuttgart New York: G. Thieme, 1985.
70. Murthy G, Ballard RE, Breit GA, Watenpaugh DE, Hargens AR. Intramuscular pressures beneath elastic and inelastic leggings. *Ann Vasc Surg* 1994;8(6):543-8.
71. Partsch H, Stoberl C, Urbanek A, Wenzel-Hora BI. Clinical use of indirect lymphography in different forms of leg edema. *Lymphology* 1988;21(3):152-60.
72. Partsch H, Winiger J, Lun B. Compression stockings reduce occupational leg swelling. *Dermatol Surg* 2004;30(5):737-43; discussion 743.
73. Blazek C, Amsler F, Blaettler W, Keo HH, Baumgartner I, Willenberg T. Compression hosiery for occupational leg symptoms and leg volume: a randomized crossover trial in a cohort of hairdressers. *Phlebology* 2012;28(5):239-47.
74. Mosti G, Picerni P, Partsch H. Compression stockings with moderate pressure are able to reduce chronic leg oedema. *Phlebology* 2011;27(6):289-96.
75. Partsch H, Damstra RJ, Mosti G. Dose finding for an optimal compression pressure to reduce chronic edema of the extremities. *Int Angiol* 2011;30(6):527-33.
76. Lattimer CR, Kalodiki E, Kafeza M, Azzam M, Geroulakos G. Quantifying the degree graduated elastic compression stockings enhance venous emptying. *Eur J Vasc Endovasc Surg* 2014;47(1):75-80.
77. Lattimer CR, Azzam M, Kalodiki E, Makris GC, Geroulakos G. Compression stockings significantly improve hemodynamic performance in post-thrombotic syndrome irrespective of class or length *J Vasc Surg* 2013;58(1):158-65.
78. Sachdeva A, Dalton M, Amaragiri SV, Lees T. Elastic compression stockings for prevention of deep vein thrombosis. *Cochrane Database Syst Rev* 2010(7):CD001484.
79. Partsch H, Partsch B, Braun W. Interface pressure and stiffness of ready made compression stockings: comparison of *in vivo* and *in vitro* measurements. *J Vasc Surg* 2006;44(4):809-14.
80. Mosti G, Partsch H. Is low compression pressure able to improve venous pumping function in patients with venous insufficiency? *Phlebology* 2010;25(3):145-50.
81. Mosti G, Partsch H. Inelastic bandages maintain their hemodynamic effectiveness over time despite significant pressure loss. *J Vasc Surg* 2010;52(4):925-31.
82. Damstra RJ, Partsch H. Prospective, Randomized Controlled Trial Comparing the Effectiveness of Adjustable Compression Velcro-Wraps *versus* Inelastic Multicomponent Compression Bandages in the Initial Treatment of Leg Lymphedema (In press). *J Vasc Surg: Venous and Lym Dis* 2015;

Chapter 5

Effects of Intermittent Pneumatic Compression and Electrical Calf Muscle Stimulation Devices on Venous Hemodynamics and the Microcirculation

Introduction

In the early days of thromboprophylaxis, both intermittent pneumatic compression (IPC)¹⁻⁸ and electrical calf stimulation (ECS)⁹ of the legs were used to prevent venous thromboembolism (VTE). However, there was primitive or no hemodynamic optimization because non-invasive blood flow studies were lacking. On the other hand, hemodynamics are not the only factors that determine risk, since mechanical methods cannot completely counteract hypercoagulopathy such as seen in cancer, a known mechanism for VTE.¹¹ Device failure has been associated with both malignancy¹² and improper use.¹³ The heterogeneity introduced could explain inconclusive results for several clinical trials comparing different devices. Nevertheless, IPC is an effective method for DVT prevention and combined modalities have been shown to be more effective than single preventive methods,^{14, 15} particularly when IPC is added to pharmacological prophylaxis.¹⁶

IPC refers to all devices that compress the leg intermittently. Some devices compress the foot only, others the calf only, and others the calf and thigh, foot and calf or foot, calf and thigh. Sequential compression device (SCD) refers to a special subgroup of IPC devices with multiple chambers inflating sequentially. ECS devices

produce intermittent electrical stimulation and contraction of calf muscles activating the calf muscle pump.

The aim of this chapter is to review the effects of IPC and ECS devices on venous hemodynamics and the microcirculation.

General considerations

Correct sleeve application for IPC is of paramount importance.¹⁷ The garments should fit snugly on patients' legs allowing only about two fingers between the sleeve and skin for effective compression. This could explain findings in one study where the post-compression refill time was very short irrespective of the device type, probably because the leg anatomy accounted for variation in flow augmentation.¹⁸

Effect of different rates of compression cycles and different pressures on venous velocity and volume flow for intermittent pneumatic compression devices used to prevent DVT

Comparison of IPC devices with different rates of compression cycles

A long deflation period of 60 seconds was chosen in the early days of IPC testing, in order to allow leg veins to refill.¹⁹ This was to prevent premature compression of leg veins but 60 seconds between compression cycles was much longer than necessary for many patients.

In two comparative studies using a sequential compression device (SCD) in normal volunteers and patients with varicose veins an adjusted-cycle of 11 seconds inflation followed by 20-60 seconds deflation, depending on the individual post-compression refilling time of the calf veins (SCD Response™) was equivalent to a device with fixed inflation/deflation settings (11 seconds and 60 seconds respectively (SCD Sequel™),^{20, 21} in terms of peak velocity of blood expelled during the 11 seconds of compression. (**Level 1 evidence**). In the same studies, single-cycle volume flow parameters (crude volume and flow volume) were similar (**Level 1 evidence**) while the most important finding of these two studies was a significant increase in total volume of blood expelled per hour with the SCD Response™ compared with the SCD Sequel™ as a result of the most frequent cycling of the former IPC device. The difference was not only statistically but also clinically signifi-

cant, with volume of blood expelled per hour increasing by 21-110%^{20, 21} (**Level 1 evidence**). It is interesting that the hourly volume increase was much larger in patients with varicose veins or post-thrombotic syndrome, both known to be at a higher risk for VTE, than in normal volunteers^{20, 21} (**Level 3 evidence**). The SCD Response™ was subsequently found to be similar in terms of the above hemodynamic parameters with its miniaturized version, the SCD Express™ IPC, which also has an optional battery power option.²²

Comparison of IPC devices with different inflation profiles (rapid vs slow) pressures

One study compared the hemodynamics of a sequential compression device (SCD Express™ Compression System) with a rapid inflation device (VenaFlow) in 12 normal volunteers using duplex ultrasound.²³ The two devices were comparable in terms of the pressure applied. Baseline and augmented flow velocity and volume flow were measured at the level of the common femoral vein just above the saphenofemoral junction. Refilling time was determined from velocity recordings in the common femoral vein. The refill time for the rapid inflation device was shorter compared to the sequential compression device (15 vs 25 sec; $P < 0.001$) suggesting incomplete leg vein evacuation. The SCD, by augmenting flow throughout a significantly longer compression period per cycle (10.9 sec vs 6.3 sec), expelled significantly more venous blood (121 vs 81 mL, $P < 0.001$). Similarly, the total volume of blood expelled per hour with the SCD was 100% higher than the rapid inflation device (9,685 vs 4,853 mL, $P < 0.001$). Peak velocity enhancement was higher with the rapid inflation device but blood flow during compression was comparable (669 vs 772 mL/min; $p = 0.22$) with the SCD, mainly because the rapid inflation device failed to maintain flow enhancement beyond the initial flow surge. Similar findings regarding higher peak velocity enhancement with rapid inflation compared to slow inflation devices have also been reported by others.²⁴ Pulsatile calf and foot or calf pneumatic compression with a rapid inflation time produced the greatest increase in peak venous velocity, whereas compression of the calf and thigh showed the greatest increase in expelled venous volume.²⁵

In another study, a rapidly inflating intermittent calf compression system and a more gently inflating equiva-

lent was applied to 20 healthy male volunteers. The rapidly inflating system produced significantly higher venous peak velocities and augmentations as expected.²⁶

Griffin et al compared the hemodynamics of slow inflation sequential compression (SCD Express™ device, variable cycling rate of 50-116 cycles/hour) with a posterior sequential rapid gradient inflation device (PSR), (constant cycling rate of 60 cycles/hour) in patients with primary bilateral varicose veins.³³ These devices inflated thigh length sleeves. Compared with the median baseline flow, both devices significantly increased flow during compression. Peak velocity increased from a baseline of 12 cm/s to 38 cm/s for the SCD and to 68 cm/s for the PSR device (both $P < 0.001$ and $P < 0.05$ for intra-device comparison in favor of the PSR device). Single cycle volume expelled during compression was 105 and 45 mL ($P < 0.005$), respectively and the total volume expelled per hour was 7,800 and 3,300 mL/hr ($P < 0.005$) respectively. The authors concluded that the higher volume expelled per hour during compression was observed with the SCD and this was due to increased volume per cycle and more compression cycles over time, because of the SCD device's sensing of refill time. Although peak velocity with the PSR device was higher compared with the SCD device, it was associated with reduced expelled volume because of its short compression period.

In summary, rapid inflation devices achieve a higher peak velocity compared with slow inflation devices but a lower volume expelled per inflation cycle (**Level 1 evidence**). However, the duration of compression was not comparable for the two types tested, simply because of manufacturer settings. Compression after full sleeve inflation in both device types was about 5-6 seconds to allow blood to be evacuated from the veins. It is unlikely that volume expelled during compression would be equal with the two devices if compression lasted for the same time because there was no active flow enhancement after the initial pressure surge with the PSR device.

Comparison of IPC devices with different pressures

The volume of blood ejected from the calf of supine subjects measured during varicose vein operations depends on the magnitude of the applied pressure, tending to a maximal value when the pressure is 40 mm Hg.^{27, 28}

In a leading investigation²⁹ pressures of 35, 30 and 20 mm Hg applied sequentially for 12 seconds at the ankle, calf and thigh respectively produced a 240% increase in peak blood velocity, whereas higher pressures did not increase velocity any further.

As discussed above, several studies have compared low pressure and high pressure (but rapid inflation) devices which therefore are not directly comparable.^{24, 30} Rapid inflation is achieved by high pressure so that these two parameters are inherent. The consensus is that high pressure devices, achieve greater velocities of venous blood flow because of rapid expulsion of blood. Compression with high pressure achieves quick evacuation of blood but beyond that point there is restriction in arterial perfusion and venous flow^{28, 31} so that the compression period for this kind of device should be short. Regarding high pressure foot IPC, increase of applied pressure from 120 to 180 mmHg offered only a small outflow improvement³² indicating that excessive pressure beyond the point of venous emptying offers no hemodynamic advantage, only patient discomfort and the chance of dislodging pre-existing thrombi in case of calf compression.

In summary, compared with standard pressure devices, high pressure devices used beyond their optimized profile do not offer additional hemodynamic advantage (**Level 1 evidence**).

Differences in the hemodynamic changes between single chamber pneumatic compression and multichamber, sequential and graduated, intermittent pneumatic compression

The first evidence that multichamber sequential compression is superior to single chamber IPC was provided a long time ago.²⁹ Graded pressures of 35, 30, and 20 mm Hg at the ankle, calf, and thigh respectively, applied sequentially for 12 seconds, produced a 240% increase in peak blood flow velocity. A single chamber non-sequential device inflated at 35 mm Hg for 12 seconds produced only a 180% increase in blood flow velocity.²⁹ In a recent study performed in patients with varicose veins,³³ a conventional sequential compression device that applied circumferential compression produced a sustained waveform of enhanced flow throughout the compression period, indicating that active compression was taking place during that period. The comparator

was a posterior uniform device which produced a biphasic compression waveform consisting of an early phase with a peak velocity which corresponded to the period the sleeve was inflating, and a late phase of passive compression during which velocity was similar to baseline readings. The approximate 40% further increase in peak velocity with the sequential compression device compared with the uniform one was not statistically significant due to the small number of patients, 12 in total. The volume of blood expelled during compression was also greater with the sequential device (mean 105 ml) than the uniform device (mean 85 ml). However, the two device types were not directly comparable because circumferential pressure was not used in both and the pressure rise time was shorter with the uniform pressure device. An additional feature that favored sequential compression was the presence of a longer venous refill time as determined by duplex ultrasound recording venous blood flow velocity indicating more complete evacuation of leg blood by the device compared with the uniform device. In another study in normal volunteers, a conventional sequential compression device was inferior to a posterior uniform device when peak velocity of expelled blood was the end-point,¹⁸ but no flow data were provided.

Sequential compression compared with uniform compression has been repeatedly shown to produce complete evacuation of the venous blood. In a venographic study performed in 10 patients, the clearance time of contrast medium from calf and thigh was significantly shorter with sequential compression (1.52 ± 0.67 min) than uniform compression (2.82 ± 1.09 min), $p=0.005$.²⁹ In a study performed in healthy human volunteers aiming to optimize indices of IPC using radionuclide gated imaging, uniform compression (intercompartmental pressure gradation equal to 0 and intercompartmental time sequencing to the onset of compression delta also equal to 0) was substantially inferior to cycles with gradation and sequencing. The optimal values of intercompartmental pressure gradation were in the range 5-10 mm Hg and of intercompartmental time sequencing to the onset of compression in the range 0-0.5 seconds.³⁴

In summary, multichamber sequential and graduated, intermittent pneumatic compression has hemodynamic advantages compared with single chamber pneumatic compression, (**Level 1 evidence**).

Compression of multiple leg segments

There is better hemodynamic performance if multiple leg segments are compressed. In a comparative study that evaluated the ability of two devices to increase blood flow in the profunda femoris vein, one device applied pressure with a single-chambered sleeve to the below knee region while the other applied pressure in a sequential gradient fashion from the ankle to the thigh.³⁵ Compression with the single-chambered device produced a significant rise in venous blood flow velocity but this could not be maintained while a higher average velocity was achieved with the sequential gradient device. Additionally, the sequential gradient device moved a greater volume of blood and achieved a higher average blood flow rate. The time between deflation of the sleeve and return of a phasic respiratory signal in blood velocity was greater after compression with the sequential gradient device indicating a more completely emptying of veins in the leg.

Similarly, IPC of the foot and calf has been shown to generate a higher venous outflow enhancement, compared with foot or calf IPC alone.³² In another study comparing calf compression with foot and calf sequential compression, the maximum velocity increased significantly with both compressions but foot and calf sequential compression tended to have a greater effect.³⁶ In another study using MR, the foot cuff contribution was insignificant when combined with the calf cuff, most likely the result of the small foot blood volume. Calf compression provides maximal increases of volume flow and flow velocity through the deep veins compared with foot compression,³⁷ known to be hemodynamically less effective.³⁸

A novel, high-pressure, plantar compression system compared with a classical low-pressure whole-leg boots system produced similar hemodynamic improvement in terms of venous blood peak velocity and flow in the common femoral vein.³⁹ However, the two devices were not directly comparable because of the confounding variable of different compression pressures.

In summary, compression of multiple leg segments probably offers hemodynamic flow advantages (**Level 2 evidence**).

Minaturised IPC devices

Miniaturized devices, very important in improving compliance with IPC use, are associated with improved

efficacy and have been shown to have similar hemodynamic properties compared with the traditional IPC systems.^{22, 40} (**Level 1 evidence**).

Passive calf compression and electrical muscle stimulation

In a study that measured femoral venous flow continuously using a thermodilution technique in volunteers, passive straight-leg elevation produced the largest flow (1524 ml per minute), followed by an anatomic continuous passive motion (CPM) device and non-anatomic CPM, then active ankle dorsiflexion (640 ml per minute), IPC (586 ml per minute), manual calf compression (532 ml per minute), and passive dorsiflexion (385 ml per minute).⁴¹ Dorsiflexion of the ankle increases average peak venous velocity by more than 200%³⁸ and foot exercise by a nurse for 5 minutes is equally or more effective compared with the IPC device in increasing peak blood flow velocity of the femoral vein.⁴² The effect of rhythmic passive flexion of the foot on femoral vein blood flow rate was investigated in a study on 11 patients undergoing surgery for varicose veins. With rates of flexion varying from 24 to 50 per minute and with amplitudes varying from 200 to 500, it was shown that the peak femoral vein blood flow can be increased to twice its normal value and that its pulsatility can be increased eleven-fold. These increases were proportional to both the rate and amplitude of the flexion, the theoretical maximum occurring when the foot is flexed $\pm 280^\circ$ about a line perpendicular to the leg.⁴³

Electrical calf muscle stimulation (ECMS) has been shown to reduce the clearance time of intravenous contrast from the soleal veins⁴⁴ and significantly increase blood flow in the deep vein system, either alone,⁴⁴⁻⁴⁸ or with co-current use of elastic stockings⁴⁵ or elastic bandaging.⁴⁶ It has been shown that hemodynamics with ECMS are improved with concomitant compression.⁴⁹ Electrically elicited calf muscle contractions significantly improve lower limb blood flow and can reverse venous stasis induced by bed rest⁴⁸ with popliteal vein flow being increased up to 10-12 times the baseline.⁴⁷ Short-term electrical foot stimulation is at least as effective as knee-high IPC in increasing popliteal and femoral blood flow velocity.⁵⁰ However, ECMS is less effective than IPC in DVT prevention⁵¹ and it is not clear if this difference is due to hemodynamic reasons.

In summary, passive calf compression and ECMS are both effective methods to enhance venous blood flow (**Level 1 evidence**).

Mechanisms for reduced venous pressure, restored venoarteriolar reflex and vasomotor activity and reduced edema using IPC in the sitting position

Effects of IPC on the microcirculation

IPC affects both the arterial and venous circulation with maximal effects in the sitting position. For a better understanding of the mechanisms involved all effects, arterial, microcirculatory and venous are presented.

Experiments in rats have shown that IPC of the legs regulates nitric oxide synthase expression in skeletal muscles,⁵² induces vasodilation in upstream muscles via nitric oxide (NO) production⁵³ and increases vasodilation in distant skeletal muscles.⁵⁴ A similar experimental study demonstrated that the inflation rate of IPC modulates IPC-induced vasodilation in the distant microcirculation while peak-pressure duration does not significantly influence the vasodilating effects from compression.⁵⁵ The greatest increase in diameter was produced by IPC with the shortest inflation rate (0.5 seconds). A moderate increase resulted from compression with an inflation rate of 5 seconds, and no effect on vasodilation occurred during compression with the longest inflation rate (10 seconds). The authors made a hypothesis that rapid inflation produced a significant increase in shear stress on the vascular wall which stimulates vascular endothelium to release NO causing systemic vasodilation. Finally, IPC in an intact bone model resulted in a significant local increase in total blood flow with minimal measurable effects on the contralateral limb.⁵⁶

In a study performed in humans (15 patients with peripheral occlusive arterial disease and 15 control subjects), the effects of foot IPC on the microcirculation in arterial disease were investigated.⁵⁷ Laser Doppler flux (LDF) and transcutaneous oxygen tension (tcPO₂) were measured on the big toe in the supine and sitting positions before, during and after a 10 min period of foot pumping. While sitting, there was a fall in LDF attributable to the venoarteriolar reflex (VAR) and a rise in tcPO₂ compared with the supine position. Application of foot IPC in the sitting position resulted in an increase in LDF. The median percentage increase was 57% in

patients while the median percentage increase was 66% in controls. Foot IPC resulted in a further increase in $tcPO_2$ in both groups of subjects with the median percentage increase in patients and controls being 8% and 10%, respectively ($p < 0.01$). The authors concluded that foot IPC in the dependent position increases LDF and $tcPO_2$. The stimulative effects of IPC on limb $tcPO_2$ in patients with peripheral occlusive arterial disease were confirmed by a recent study.⁵⁸

IPC of the foot and calf has been shown to increase arterial flow in normal individuals due to a dramatic decrease in the peripheral vascular resistance as the peak systolic and end diastolic flow velocities increase and the reverse-flow component diminishes.⁵⁹ In a further study in limbs with infrainguinal bypass, IPC enhanced skin LDF with IPC of the foot, with IPC of the foot and calf being more effective than IPC of the calf alone. The authors concluded that IPC may be beneficial in limbs with impaired distal perfusion and thus may have clinical implications in the treatment of leg ulcers either prior to or after revascularization.⁶⁰ In a similar study, IPC increased infrainguinal graft flow velocity, probably by reducing peripheral resistance.⁶¹ All IPC modes (foot, calf, foot and calf) significantly enhanced mean, peak and end-diastolic velocity and volume flow in both femoro-popliteal and femoro-distal grafts. IPC of the foot and calf was the most effective. IPC of the foot and calf enhanced median volume flow, mean and peak velocity in femoropopliteal grafts by 182, 236 and 49 per cent, respectively, and attenuated pulsatility index (PI) by 61 per cent. Enhancement in femorodistal grafts was 273, 179 and 53 per cent respectively, and PI attenuation was 63 per cent. The increase of EDV and decrease of PI indicates that decrease of peripheral arteriolar resistance is the main mechanism underlying flow enhancement. The authors suggested that IPC has the potential to reduce the risk of bypass graft thrombosis.⁶² Impulse-related flow augmentation has been shown in another study confirming that peripheral vasodilatation is the central mechanism.⁶³

In a study in patients undergoing surgery for varicose veins, the elimination rate of ^{99}Tcm -macroaggregated albumin from the calf of the contralateral apparently normal leg was studied with two modes of IPC compared - a slow and a fast pattern as well as a control group without compression. For reasons that are not clear, the radioisotope elimination rate was slower with compression than without.⁶⁴

In summary, IPC modulates distant microcirculation probably due to NO production, and decreases peripheral resistance which leads to increased arterial flow (**Level 1 evidence**).

Effects of IPC on macrohemodynamics

A detailed discussion on the effect of IPC on venous hemodynamics using Doppler was provided above, but MRI is a new tool that has recently been applied. Comparison of hemodynamic and MRI data has shown a high correlation between flow velocity increase caused by IPC in the femoral and greater saphenous veins and the decrease in volume of superficial veins and subcutaneous tissue measured by MRI, but not with changes in subfascial volume. The single strongest predictor of venous blood flow increase was the change in subcutaneous venous blood volume.⁶⁵

The effect of IPC on heart function has been studied. Sequential IPC to the lower limbs caused minor increase in mean arterial blood pressure and moderate reduction of cardiac output and heart rate in one study.⁶⁶ Sequential IPC devices in normal volunteers augmented cardiac output because of increased preload as well as decreased afterload in another study.⁶⁷ Others found a non significant change in central hemodynamics in patients with congestive heart failure.⁶⁸ Finally IPC of the legs has been shown to significantly improve hemodynamic stability and reduce fluid demand during minor surgery.⁶⁹

The effect of sequential IPC on postoperative venous function was investigated some time ago. Sequential IPC prevented postoperative decrease in venous capacitance and venous outflow in both the pumped and non-pumped leg.⁷⁰ Of note, a highly significant correlation between reduction in venous outflow and development of postoperative DVT has been reported.⁷¹

In summary, with the exception of limb venous hemodynamics, the effects of IPC are poorly studied or conflicting results have been reported.

Effects of IPC on venous stasis in laparoscopic surgery

Laparoscopic surgery is known to be associated with venous stasis as a result of increased venous pressure due to the pneumoperitoneum. The hemodynamic effects of IPC of the lower limbs during laparoscopic

cholecystectomy were investigated in one study. Pneumoperitoneum was found to increase femoral vein diameter by 17% in volunteers and 14% in patients, and decrease peak velocity by 49% and 32% respectively. IPC of the legs restored venous flow velocity.⁷² Three additional studies have reported similar findings that IPC effectively neutralizes venous stasis during laparoscopic surgery.⁷³⁻⁷⁵ One of these also demonstrated an increase in cardiac output by 27% and stroke volume by 16%.⁷⁵

In summary, IPC reduces venous stasis induced by increased venous pressure due to pneumoperitoneum during laparoscopic surgery (**Level 1 evidence**).

Effects of IPC on the veno-arteriolar reflex

Change in posture from supine to the sitting position leads to distension of leg veins, increase in venous pressure and activation of the VAR, resulting in arteriolar vasoconstriction with a decrease in blood flow in the leg. The VAR is an axon reflex which is elicited when the venous pressure exceeds 40 mmHg.^{76, 77} This is the physiological mechanism that prevents development of edema (see chapter 3). IPC has been shown to restore blood flow by reducing venous volume of the leg and thus venous pressure, abolishing the VAR and restoring blood flow. In one study, there was significant reduction in popliteal artery blood flow on moving from the supine to the sitting position.⁷⁸ Popliteal artery blood flow was higher than baseline after 15 minutes of intermittent pneumatic foot and calf compression, and this increase in popliteal artery blood flow was still present 10 minutes after cessation of IPC. The effect of sequential IPC of the foot and calf on popliteal artery mean systolic blood flow in patients with intermittent claudication was investigated in another study. There was a consistent decrease in flow from moving from supine to sitting and to standing in all patients. Immediately after IPC application, there was an increase in flow ranging from 29-335% ($p < 0.05$).⁷⁹ Leg blood inflow enhancement with foot IPC has been shown to be mediated by a transient suspension of peripheral sympathetic auto-regulation,⁸⁰ while the late phase of flow enhancement (35 to 50 seconds) with IPC could be attributable to a declining arteriovenous pressure gradient alone.⁸¹ In another study, the integrity of the VAR correlated with the level of skin blood flow augmentation generated with

IPC, perhaps due to a transient suspension of the auto-regulatory vasoconstriction both in healthy controls and in patients with PAD.⁸² In patients with chronic venous insufficiency (CVI), a short cycle of IPC enhances venous tone as manifested by reduction in the diameter of the common femoral and the great and small saphenous veins on ultrasound.⁸³ Both long and short cycles of IPC were able to enhance the venous tone in CVI patients for at least 30 minutes after the end of treatment. Improved venous function could enhance edema absorption in CVI patients in addition to local pressure as described below.

Recent IPC devices are able to measure individual post-compression refilling time (RT) of the calf veins. Body position affected RT being longer in the sitting position), indicating not only the devices ability to detect changes in filling times and venous blood volume but also the presence of the VAR.^{20, 84}

In an investigation of the sympathetic reflex control of resistance in collateral arteries in the lower extremities in patients with diabetes mellitus, resistance of collateral arteries increased by 40% during head-up tilt compared with the horizontal position, and total leg resistance was increased by 24%.⁸⁵ Intra-arterial injection of the alpha-blocker phentolamine abolished the increase of vascular constriction in the leg during head-up tilt indicating that alpha-adrenergic tone was involved in this observation. Finally, one study that investigated the hemodynamic effects of IPC in patients with critical limb ischemia showed that those with significant venous reflux may not benefit from IPC, an observation that supports the theory that one of the mechanisms by which IPC enhances flow is by increasing the arteriovenous pressure gradient.⁸⁶

In summary, the sitting position leads to distension of leg veins and activation of the VAR resulting in a decrease in blood flow in the leg. IPC has been shown to restore blood flow by reducing venous volume and venous pressure, increasing the arteriovenous pressure gradient, abolishing VAR and thus restoring arterial blood flow (**Level 1 evidence**).

Effects of IPC and positioning

IPC devices work well in a variety of leg positions. The reverse Trendelenburg position is associated with better efficacy of foot pumps indicating a priming ef-

fect.⁸⁷ Both rapid and standard IPC devices are effective for maintaining venous flow in the lower extremities in the lithotomy position.⁸⁸

In summary, IPC devices work well in a variety of leg positions but there is only limited data (*Level 2 evidence*).

Effects of IPC on leg edema

IPC is effective in controlling both acute and chronic swelling after surgery and trauma of the foot and ankle,⁸⁹ including calcaneus fractures,⁹⁰ chronic posttraumatic hand edema,⁹¹ and also enhancing fracture and soft-tissue healing.⁹² IPC has been shown to be a useful adjunct in preoperative edema resolution after ankle fracture.⁹³ A study has shown that the pressure generated by IPC is transmitted to the muscles of the leg compartments and obviously to the other deeper structures, which could explain the beneficial effects of IPC.⁹⁴ Despite transmission of high pressures to the leg muscles which renders them transiently ischemic, IPC including foot IPC,⁹³ is well tolerated by the majority of patients.

Lower pressures together with shorter inflation and deflation times have been shown to be more effective than higher pressures and long inflation/deflation times. In addition, the lack of significant reduction in edema at pressures above 40 mmHg suggests that higher pressures cause a tourniquet effect.⁹⁵ It seems that the mechanism responsible for edema reduction is local compression of the edematous tissue. This could explain the findings of a study where calf-thigh pneumatic compression was found to be more effective than plantar compression for reducing thigh swelling during the early postoperative stage.⁹⁶ Although effective in edema reduction, IPC has a limited clinical role for treating post-mastectomy lymphedema⁹⁷ which is likely to be the result of the protein rich composition and hard nature of the lymphoedematous tissue.

In summary, IPC devices reduce leg edema (*Level 1 evidence*).

References

- Henry JP, Slaughter OL, Greiner T. A medical massage suit for continuous wear. *Angiology*. 1955;6(5): 482-494.
- Allwood MJ. The effect of an increased local pressure gradient on blood flow in the foot. *Clin Sci (Lond)*. 1957;16(2): 231-239.
- Loane RA. Effect of rhythmically inflating a pneumatic cuff at the ankle on blood flow in the foot. *J Appl Physiol*. 1959;14(3): 411-414.
- Calnan JS, Pflug JJ, Mills CJ. Pneumatic intermittent-compression legging simulating calf-muscle pump. *Lancet*. 1970;2(7671): 502-503.
- Hills NH, Pflug JJ, Jeyasingh K, Boardman L, Calnan JS. Prevention of deep vein thrombosis by intermittent pneumatic compression of calf. *Br Med J*. 1972;1(5793): 131-135.
- Clark WB, MacGregor AB, Prescott RJ, Ruckley CV. Pneumatic compression of the calf and postoperative deep-vein thrombosis. *Lancet*. 1974;2(7871): 5-7.
- Lee BY, Trainor FS, Kavner D, Madden JL, Dratz HM, Ejercito EM. Noninvasive prevention of thrombosis of deep veins of the thigh using intermittent pneumatic compression. *Surg Gynecol Obstet*. 1976;142(5): 705-714.
- Sabri S, Roberts VC, Cotton LT. The effects of intermittently applied external pressure on the haemodynamics of the hind-limb in greyhound dogs. *Br J Surg*. 1972;59(3): 219-222.
- Tichy VL, Zankel HT. Prevention of venous thrombosis and embolism by electrical stimulation of calf muscles; further study of clinical application and results. *Arch Phys Med Rehabil*. 1949;30(11): 711-715.
- Elliott CG, Dudney TM, Egger M, Orme JF, Clemmer TP, Horn SD, et al. Calf-thigh sequential pneumatic compression compared with plantar venous pneumatic compression to prevent deep-vein thrombosis after non-lower extremity trauma. *J Trauma*. 1999;47(1): 25-32.
- Virchow R. Phlogose und thrombose im gefässsystem. In: Virchow R, ed. *Gesammelte Adhandlungen zur Wissenschaftlichen Medicin*. Frankfurt A.M.: von Meidinger Sohn & Comp, 1856; 458-636.
- Clarke-Pearson DL, Dodge RK, Synan I, McClelland RC, Maxwell GL. Venous thromboembolism prophylaxis: patients at high risk to fail intermittent pneumatic compression. *Obstet Gynecol*. 2003;101(1): 157-163.
- Comerota AJ, Katz ML, White JV. Why does prophylaxis with external pneumatic compression for deep vein thrombosis fail? *Am J Surg*. 1992;164(3): 265-268.
- Kakkos SK, Caprini JA, Geroulakos G, Nicolaidis AN, Stansby GP, Reddy DJ. Combined intermittent pneumatic leg compression and pharmacological prophylaxis for prevention of venous thromboembolism in high-risk patients. *Cochrane Database Syst Rev*. 2008(4): CD005258.
- Kakkos SK, Caprini JA, Geroulakos G, Nicolaidis AN, Stansby GP, Tsolakis IA, Reddy DJ. Can combined (mechanical and pharmacological) modalities prevent fatal VTE? *Int Angiol*. 2011;30(2): 115-122.
- Kakkos SK, Warwick D, Nicolaidis AN, Stansby GP, Tsolakis IA. Combined (mechanical and pharmacological) modalities for the prevention of venous thromboembolism in joint replacement surgery. *J Bone Joint Surg Br*. 2012;94(6): 729-734.
- Salvian AJ, Baker JD. Effects of intermittent pneumatic calf compression in normal and postphlebotic legs. *J Cardiovasc Surg (Torino)*. 1988;29(1): 37-41.
- Flam E, Berry S, Coyle A, Dardik H, Raab L. Blood-flow augmentation of intermittent pneumatic compression systems used for prevention of deep vein thrombosis prior to surgery. *Am J Surg*. 1996;171(3): 312-315.
- Nicolaidis AN, Kakkar VV, Field ES, Spindler J. Soleal veins and stasis during operation. *Br J Surg*. 1972;59(4): 304.
- Kakkos SK, Szendro G, Griffin M, Daskalopoulou SS, Nicolaidis AN. The efficacy of the new SCD response compression system in the prevention of venous stasis. *J Vasc Surg*. 2000;32(5): 932-940.
- Kakkos SK, Szendro G, Griffin M, Sabetai MM, Nicolaidis AN. Improved hemodynamic effectiveness and associated clinical correlations of a new intermittent pneumatic compression system in patients with chronic venous insufficiency. *J Vasc Surg*. 2001;34(5): 915-922.
- Kakkos SK, Griffin M, Geroulakos G, Nicolaidis AN. The efficacy of a new portable sequential compression device (SCD Express) in preventing venous stasis. *J Vasc Surg*. 2005;42(2): 296-303.
- Kakkos SK, Nicolaidis AN, Griffin M, Geroulakos G. Comparison of two intermittent pneumatic compression systems. A hemodynamic study. *Int Angiol*. 2005;24(4): 330-335.

- 24 Malone MD, Cisek PL, Comerota AJ, Jr., Holland B, Eid IG, Comerota AJ. High-pressure, rapid-inflation pneumatic compression improves venous hemodynamics in healthy volunteers and patients who are post-thrombotic. *J Vasc Surg.* 1999;29(4): 593-599.
- 25 Westrich GH, Specht LM, Sharrock NE, Sculco TP, Salvati EA, Pellicci PM, *et al.* Pneumatic compression hemodynamics in total hip arthroplasty. *Clin Orthop Relat Res.* 2000(372): 180-191.
- 26 Morris RJ, Giddings JC, Ralis HM, Jennings GM, Davies DA, Woodcock JP, Dunstan FD. The influence of inflation rate on the hematologic and hemodynamic effects of intermittent pneumatic calf compression for deep vein thrombosis prophylaxis. *J Vasc Surg.* 2006;44(5): 1039-1045.
- 27 Roberts VC. External pressure and femoral-vein flow. *Lancet.* 1971;297(7690): 136-137.
- 28 Ah-See AK, Arfors KE, Bergqvist D, Dahlgren S. The haemodynamic and antithrombotic effects of intermittent pneumatic calf compression of femoral vein blood flow. A comparison between different pump types. *Acta Chir Scand.* 1976;142(5): 381-385.
- 29 Nicolaides AN, Fernandes e Fernandes J, Pollock AV. Intermittent sequential pneumatic compression of the legs in the prevention of venous stasis and postoperative deep venous thrombosis. *Surgery.* 1980;87(1): 69-76.
- 30 Muhe E. Intermittent sequential high-pressure compression of the leg. A new method of preventing deep vein thrombosis. *Am J Surg.* 1984;147(6): 781-785.
- 31 Spiro M, Roberts VC, Richards JB. Effect of externally applied pressure on femoral vein blood flow. *Br Med J.* 1970;1(5698): 719-723.
- 32 Delis KT, Slimani G, Hafez HM, Nicolaides AN. Enhancing venous outflow in the lower limb with intermittent pneumatic compression. A comparative haemodynamic analysis on the effect of foot vs. calf vs. foot and calf compression. *Eur J Vasc Endovasc Surg.* 2000;19(3): 250-260.
- 33 Griffin M, Kakkos SK, Geroulakos G, Nicolaides AN. Comparison of three intermittent pneumatic compression systems in patients with varicose veins: a hemodynamic study. *Int Angiol.* 2007;26(2): 158-164.
- 34 Kamm R, Butcher R, Froelich J, Johnson M, Salzman E, Shapiro A, Strauss HW. Optimisation of indices of external pneumatic compression for prophylaxis against deep vein thrombosis: radionuclide gated imaging studies. *Cardiovasc Res.* 1986;20(8): 588-596.
- 35 Janssen H, Trevino C, Williams D. Hemodynamic alterations in venous blood flow produced by external pneumatic compression. *J Cardiovasc Surg (Torino).* 1993;34(5): 441-447.
- 36 Iwama H, Obara S, Ohmizo H. Changes in femoral vein blood flow velocity by intermittent pneumatic compression: calf compression device *versus* plantar-calf sequential compression device. *J Anesth.* 2004;18(3): 232-233.
- 37 Lurie F, Awaya DJ, Kistner RL, Eklof B. Hemodynamic effect of intermittent pneumatic compression and the position of the body. *J Vasc Surg.* 2003;37(1): 137-142.
- 38 Whitelaw GP, Oladipo OJ, Shah BP, DeMuth KA, Coffman J, Segal D. Evaluation of intermittent pneumatic compression devices. *Orthopedics.* 2001;24(3): 257-261.
- 39 Christen Y, Wutschert R, Weimer D, de Moerloose P, Kruihof EK, Bounameaux H. Effects of intermittent pneumatic compression on venous haemodynamics and fibrinolytic activity. *Blood Coagul Fibrinolysis.* 1997;8(3): 185-190.
- 40 Dohm M, Williams KM, Novotny T. Micro-mobile foot compression device compared with pneumatic compression device. *Clin Orthop Relat Res.* 2011;469(6): 1692-1700.
- 41 von Schroeder HP, Coutts RD, Billings E, Jr., Mai MT, Aratow M. The changes in intramuscular pressure and femoral vein flow with continuous passive motion, pneumatic compressive stockings, and leg manipulations. *Clin Orthop Relat Res.* 1991(266): 218-226.
- 42 Yamashita K, Yokoyama T, Kitaoka N, Nishiyama T, Manabe M. Blood flow velocity of the femoral vein with foot exercise compared to pneumatic foot compression. *J Clin Anesth.* 2005;17(2): 102-105.
- 43 Roberts VC, Sabri S, Pietroni MC, Gurewich V, Cotton LT. Passive flexion and femoral vein flow: a study using a motorized foot mover. *Br Med J.* 1971;3(5766): 78-81.
- 44 Nicolaides AN, Kakkar VV, Field ES, Fish P. Optimal electrical stimulus for prevention of deep vein thrombosis. *Br Med J.* 1972;3(5829): 756-758.
- 45 Lyons GM, Leane GE, Grace PA. The effect of electrical stimulation of the calf muscle and compression stocking on venous blood flow velocity. *Eur J Vasc Endovasc Surg.* 2002;23(6): 564-566.
- 46 Clarke Moloney M, Lyons GM, Breen P, Burke PE, Grace PA. Haemodynamic study examining the response of venous blood flow to electrical stimulation of the gastrocnemius muscle in patients with chronic venous disease. *Eur J Vasc Endovasc Surg.* 2006;31(3): 300-305.
- 47 Griffin M, Nicolaides AN, Bond D, Geroulakos G, Kalodiki E. The efficacy of a new stimulation technology to increase venous flow and prevent venous stasis. *Eur J Vasc Endovasc Surg.* 2010;40(6): 766-771.
- 48 Broderick BJ, O'Briain DE, Breen PP, Kearns SR, O'laighin G. A pilot evaluation of a neuromuscular electrical stimulation (NMES) based methodology for the prevention of venous stasis during bed rest. *Med Eng Phys.* 2010;32(4): 349-355.
- 49 Cotton LT, Clark C. Anatomical Localization of Venous Thrombosis. *Ann R Coll Surg Engl.* 1965;36: 214-224.
- 50 Czynny JJ, Kaplan RE, Wilding GE, Purdy CH, Hirsh J. Electrical foot stimulation: a potential new method of deep venous thrombosis prophylaxis. *Vascular.* 2010;18(1): 20-27.
- 51 Nicolaides AN, Miles C, Hoare M, Jury P, Helms E, Venniker R. Intermittent sequential pneumatic compression of the legs and thromboembolism-deterrent stockings in the prevention of postoperative deep venous thrombosis. *Surgery.* 1983;94(1): 21-25.
- 52 Tan X, Qi WN, Gu X, Urbaniak JR, Chen LE. Intermittent pneumatic compression regulates expression of nitric oxide synthases in skeletal muscles. *J Biomech.* 2006;39(13): 2430-2437.
- 53 Chen LE, Liu K, Qi WN, Joneschild E, Tan X, Seaber AV, *et al.* Role of nitric oxide in vasodilation in upstream muscle during intermittent pneumatic compression. *J Appl Physiol.* 2002;92(2): 559-566.
- 54 Liu K, Chen LE, Seaber AV, Johnson GW, Urbaniak JR. Intermittent pneumatic compression of legs increases microcirculation in distant skeletal muscle. *J Orthop Res.* 1999;17(1): 88-95.
- 55 Liu K, Chen LE, Seaber AV, Urbaniak JR. Influences of inflation rate and duration on vasodilatory effect by intermittent pneumatic compression in distant skeletal muscle. *J Orthop Res.* 1999;17(3): 415-420.
- 56 Park SH, Silva M. Intermittent pneumatic soft tissue compression: Changes in periosteal and medullary canal blood flow. *J Orthop Res.* 2008;26(4): 570-577.
- 57 Abu-Own A, Cheattle T, Scurr JH, Coleridge Smith PD. Effects of intermittent pneumatic compression of the foot on the microcirculatory function in arterial disease. *Eur J Vasc Surg.* 1993;7(5): 488-492.
- 58 Chang ST, Hsu JT, Chu CM, Pan KL, Jang SJ, Lin PC, *et al.* Using intermittent pneumatic compression therapy to improve quality of life for symptomatic patients with infrapopliteal diffuse peripheral obstructive disease. *Circ J.* 2012;76(4): 971-976.
- 59 Labropoulos N, Watson WC, Mansour MA, Kang SS, Littooy FN, Baker WH. Acute effects of intermittent pneumatic compression on popliteal artery blood flow. *Arch Surg.* 1998;133(10): 1072-1075.
- 60 Delis KT, Husmann MJ, Nicolaides AN, Wolfe JH, Cheshire NJ. Enhancing foot skin blood flux in peripheral vascular disease using intermittent pneumatic compression: controlled study on claudicants and grafted arteriopathies. *World J Surg.* 2002;26(7): 861-866.
- 61 Delis KT, Husmann MJ, Szendro G, Peters NS, Wolfe JH, Mansfield AO. Haemodynamic effect of intermittent pneumatic compression of the leg after infrainguinal arterial bypass grafting. *Br J Surg.* 2004;91(4): 429-434.
- 62 Delis KT, Labropoulos N, Nicolaides AN, Glenville B, Stansby G. Effect of intermittent pneumatic foot compression on popliteal artery haemodynamics. *Eur J Vasc Endovasc Surg.* 2000;19(3): 270-277.
- 63 Delis KT, Nicolaides AN, Labropoulos N, Stansby G. The acute effects of intermittent pneumatic foot *versus* calf *versus* simultaneous foot and calf compression on popliteal artery hemodynamics: a comparative study. *J Vasc Surg.* 2000;32(2): 284-292.

- 64 Bergqvist D, Ljungner H, Nilsson M. Venous emptying from the calf. Methodologic report and effect of intermittent pneumatic compression. *Acta Chir Scand*. 1982;148(8): 669-673.
- 65 Lurie F, Scott V, Yoon HC, Kistner RL. On the mechanism of action of pneumatic compression devices: Combined magnetic resonance imaging and duplex ultrasound investigation. *J Vasc Surg*. 2008;48(4): 1000-1006.
- 66 Fanelli G, Zasa M, Baciarello M, Mazzani R, Di Cianni S, Rossi M, Casati A. Systemic hemodynamic effects of sequential pneumatic compression of the lower limbs: a prospective study in healthy volunteers. *J Clin Anesth*. 2008;20(5): 338-342.
- 67 Bickel A, Shturman A, Grevtzev I, Roguin N, Eitan A. The physiological impact of intermittent sequential pneumatic compression (ISPC) leg sleeves on cardiac activity. *Am J Surg*. 2011;202(1): 16-22.
- 68 Ringley CD, Johanning JM, Gruenberg JC, Veverka TJ, Barber KR. Evaluation of pulmonary arterial catheter parameters utilizing intermittent pneumatic compression boots in congestive heart failure. *Am Surg*. 2002;68(3): 286-289; discussion 289-290.
- 69 Kiefer N, Theis J, Putensen-Himmer G, Hoefl A, Zenker S. Peristaltic pneumatic compression of the legs reduces fluid demand and improves hemodynamic stability during surgery: a randomized, prospective study. *Anesthesiology*. 2011;114(3): 536-544.
- 70 Blackshear WM, Jr., Prescott C, LePain F, Benoit S, Dickstein R, Seifert KB. Influence of sequential pneumatic compression on post-operative venous function. *J Vasc Surg*. 1987;5(3): 432-436.
- 71 McNally MA, Mollan RA. Total hip replacement, lower limb blood flow and venous thrombogenesis. *J Bone Joint Surg Br*. 1993;75(4): 640-644.
- 72 Christen Y, Reymond MA, Vogel JJ, Klopfenstein CE, Morel P, Bounameaux H. Hemodynamic effects of intermittent pneumatic compression of the lower limbs during laparoscopic cholecystectomy. *Am J Surg*. 1995;170(4): 395-398.
- 73 Schwenk W, Bohm B, Fugener A, Muller JM. Intermittent pneumatic sequential compression (ISC) of the lower extremities prevents venous stasis during laparoscopic cholecystectomy. A prospective randomized study. *Surg Endosc*. 1998;12(1): 7-11.
- 74 Millard JA, Hill BB, Cook PS, Fenoglio ME, Stahlgren LH. Intermittent sequential pneumatic compression in prevention of venous stasis associated with pneumoperitoneum during laparoscopic cholecystectomy. *Arch Surg*. 1993;128(8): 914-918; discussion 918-919.
- 75 Alishahi S, Francis N, Crofts S, Duncan L, Bickel A, Cuschieri A. Central and peripheral adverse hemodynamic changes during laparoscopic surgery and their reversal with a novel intermittent sequential pneumatic compression device. *Ann Surg*. 2001;233(2): 176-182.
- 76 Belcaro G, Grigg M, Rulo A, Nicolaidis A. Blood flow in the perimalleolar skin in relation to posture in patients with venous hypertension. *Ann Vasc Surg*. 1989;3(1): 5-7.
- 77 Henriksen O. Local reflex in microcirculation in human subcutaneous tissue. *Acta Physiol Scand*. 1976;97(4): 447-456.
- 78 Mokhtar S, Azizi ZA, Govindarajanthran N. Prospective study to determine the effect of intermittent pneumatic foot and calf compression on popliteal artery peak systolic blood flow. *Asian J Surg*. 2008;31(3): 124-129.
- 79 Anthonysamy D, Azizi ZA, Tajri HM. The effect of sequential intermittent pneumatic compression of foot and calf on popliteal artery mean systolic blood flow in patients with intermittent claudication. *Asian J Surg*. 2012;35(4): 131-135.
- 80 Delis KT, Nicolaidis AN, Wolfe JH. Peripheral sympathetic autoregulation in arterial calf inflow enhancement with intermittent pneumatic compression. *Eur J Vasc Endovasc Surg*. 2001;22(4): 317-325.
- 81 Delis KT, Knaggs AL. Duration and amplitude decay of acute arterial leg inflow enhancement with intermittent pneumatic leg compression: an insight into the implicated physiologic mechanisms. *J Vasc Surg*. 2005;42(4): 717-725.
- 82 Husmann M, Willenberg T, Keo HH, Spring S, Kalodiki E, Delis KT. Integrity of venoarteriolar reflex determines level of microvascular skin flow enhancement with intermittent pneumatic compression. *J Vasc Surg*. 2008;48(6): 1509-1513.
- 83 Harfouche JN, Theys S, Hanson P, Schoevaerds JC, Sturbois X. Venous tonus enhancement after a short cycle of intermittent pneumatic compression. *Phlebology*. 2008;23(2): 58-63.
- 84 Diamantopoulos I, Lever MJ. Can an intermittent pneumatic compression system monitor venous filling in the leg? *J Med Eng Technol*. 2008;32(3): 221-227.
- 85 Agerskov K, Tonnesen KH. Sympathetic reflex control of resistance in collateral arteries in the lower extremities in patients with diabetes mellitus. *Acta Chir Scand*. 1982;148(8): 663-667.
- 86 Labropoulos N, Leon LR, Jr., Bhatti A, Melton S, Kang SS, Mansour AM, Borge M. Hemodynamic effects of intermittent pneumatic compression in patients with critical limb ischemia. *J Vasc Surg*. 2005;42(4): 710-716.
- 87 Pitto RP, Hamer H, Kuhle JW, Radespiel-Troger M, Pietsch M. [Hemodynamics of the lower extremity with pneumatic foot compression. Effect on leg position]. *Biomed Tech (Berl)*. 2001;46(5): 124-128.
- 88 Kohro S, Yamakage M, Takahashi T, Kondo M, Ota K, Namiki A. Intermittent pneumatic compression prevents venous stasis in the lower extremities in the lithotomy position. *Can J Anaesth*. 2002;49(2): 144-147.
- 89 Myerson MS, Henderson MR. Clinical applications of a pneumatic intermittent impulse compression device after trauma and major surgery to the foot and ankle. *Foot Ankle*. 1993;14(4): 198-203.
- 90 Myerson MS, Juliano PJ, Koman JD. The use of a pneumatic intermittent impulse compression device in the treatment of calcaneus fractures. *Mil Med*. 2000;165(10): 721-725.
- 91 Griffin JW, Newsome LS, Stralka SW, Wright PE. Reduction of chronic posttraumatic hand edema: a comparison of high voltage pulsed current, intermittent pneumatic compression, and placebo treatments. *Phys Ther*. 1990;70(5): 279-286.
- 92 Khanna A, Gougoulias N, Maffulli N. Intermittent pneumatic compression in fracture and soft-tissue injuries healing. *Br Med Bull*. 2008;88(1): 147-156.
- 93 Thordarson DB, Ghalambor N, Perlman M. Intermittent pneumatic pedal compression and edema resolution after acute ankle fracture: a prospective, randomized study. *Foot Ankle Int*. 1997;18(6): 347-350.
- 94 Gilbert MK, Oglivie-Harris DJ, Broadhurst C, Clarfield M. Anterior tibial compartment pressures during intermittent sequential pneumatic compression therapy. *Am J Sports Med*. 1995;23(6): 769-772.
- 95 Grieveson S. Intermittent pneumatic compression pump settings for the optimum reduction of oedema. *J Tissue Viability*. 2003;13(3): 98-100, 102, 104 passim.
- 96 Fujisawa M, Naito M, Asayama I, Kambe T, Koga K. Effect of calf-thigh intermittent pneumatic compression device after total hip arthroplasty: comparative analysis with plantar compression on the effectiveness of reducing thrombogenesis and leg swelling. *J Orthop Sci*. 2003;8(6): 807-811.
- 97 Dini D, Del Mastro L, Gozza A, Lionetto R, Garrone O, Forno G, *et al*. The role of pneumatic compression in the treatment of post-mastectomy lymphedema. A randomized phase III study. *Ann Oncol*. 1998;9(2): 187-190.

Chapter 6. Effect of pharmacotherapy on venous tone, flow and the microcirculation

Veno-active drugs

Veno-active drugs (VADs) constitute a diverse group of medications most of which are of plant origin. Recent reviews have identified five main types listed below.¹ The first four categories are drugs of plant origin.

1. Alpha-benzopyrones, notably coumarin.
2. Gamma-benzopyrones, also known as flavonoids, which include diosmin, micronized purified flavonoid fraction (MPFF) and rutosides, including rutin, troxerutin and hydroxyethylrutosides (HR).
3. Saponins, including horse chestnut seed extract (HCSE) and *Ruscus* extract.
4. Other plant extracts, including anthocyanins, proanthocyanidins (grape seed extract, red-vine-leaf extract), *Ginkgo biloba* extract and *Centella asiatica* extract.
5. Synthetic products (chemical family of quinons) which include naftazone and calcium dobesilate.

Other medications

Glycosaminoglycans (GAG) are another group of drug which is mentioned in this document since it has relatively high affinity for endothelial cells, as many heparins,² GAG consist of a mixture of electrophoretically fast moving heparin (80% of the mass) and dermatan sulfate and exhibits anticoagulant, and anti-thrombotic properties in models of venous and arterial thrombosis.³

Pharmacotherapy is commonly used as part of a repertoire of venous treatments in many parts of Europe, and most VADs are classified as medicines and thus require a marketing authorization and medical prescription. In the UK, however, many of these drugs are not licensed or available. In the US, VADs such as horse chestnut seed extract, *Ginkgo biloba*, and maritime pine tree extract are available. Some of these drugs are promoted as « dietary supplements » and can be used without medical advice, while others are “medical food” and are taken under medical supervision.

Macrocirculation

As indicated in previous chapters, macrocirculation comprises large veins and venules of at least 1 millimeter in size. The superficial vein network is responsible for blood collection from supra-aponeurotic tissues and drains itself in the deep system through the perforators. Veins of the lower limb allow blood to flow towards the heart provided venous valves are competent. Limb veins are described in the anatomical (A) part of the CEAP classification and hemodynamic anomalies in the physiopathological (P) part of it. Current investiga-

tions on the pathophysiology of chronic venous disease (CVD) consider and evaluate the valvular competence of deep, perforator and superficial veins. In the last system only of the saphenous trunks and their first generation tributaries are investigated by ultrasound

Venous tone and vasoconstriction

Veins are equipped with a smooth muscle layer located mainly in the tunica media, which is smaller than in arteries. The structure of the tunica media in human saphenous veins would account for its low distensibility upon changes in blood pressure.⁴ Smooth muscle cells in normal veins are contractile and responsive to receptor-dependent vasoconstrictor stimuli mediated by $\alpha 1$ and $\alpha 2$ adrenergic receptors. Adrenaline and noradrenaline of circulating endogenous or exogenous origin are receptor ligands to either $\alpha 1$ or $\alpha 2$ receptors. Venous tone is maintained by continuous adrenergic stimulation and depends on the local concentration of adrenaline and other catecholamines in the receptor surroundings. The local concentration of these catecholamines is regulated by two enzymes: monoamine oxidases (MAOs) and catechol-*O*-methyltransferase (COMT). Stimulation of $\alpha 1$ receptors leads to increased intracellular Ca^{2+} which results in smooth muscle contraction and vasoconstriction. Ca^{2+} is considered the major regulator of venous smooth muscle function.⁵ On the other hand, stimulated $\alpha 2$ receptors cause a decrease of cyclic adenosine monophosphate (cAMP) activity, resulting also in vasoconstriction.⁶ In experimental studies, the constriction could be blocked by low concentrations of prazosin ($\alpha 1$ -adrenoceptor agonist) or diltiazem (calcium blocker) or by high concentrations of rauwolscine ($\alpha 2$ -adrenoceptor antagonist).⁷ Varicose veins have decreased contractility upon stimulation with noradrenaline, endothelin and potassium chloride when compared with normal saphenous veins. The mechanism responsible for decreased varicose veins contractility is receptor mediated.⁸

Most VADs have been shown to increase venous tone by a mechanism related to the noradrenaline pathway. Micronized purified flavonoid fraction (MPFF) and diosmin prolong noradrenergic activity,^{9,10} by inhibiting the COMT, thereby decreasing the metabolism of norepinephrine and prolonging its vasoconstrictor effects.¹⁰⁻¹² Hydroxyethylrutosides act by blocking inactivation of noradrenaline,¹³ and escin and ruscus extracts act by ago-

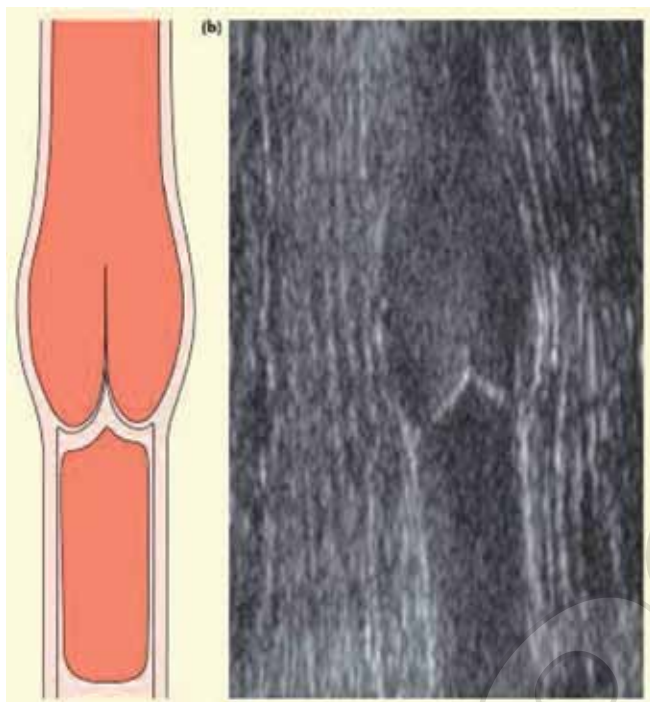

Figure 6.1A.—Competent venous valve (closed), schematic and B-flow ultrasound images. Courtesy of R J Lane.

nism on venous α 1-adrenergic receptors.¹⁴ Escin increases endothelial cell permeability to Ca^{2+} and the release of vasoconstrictors, while the venous contraction induced by MPFF is not Ca^{2+} -dependent.¹⁵ Escin also induces small pores in the plasma membrane which allows Ca^{2+} to diffuse freely across, and make the cell membrane permeable to higher molecular weight solutes.¹⁴ A high affinity for the venous wall was found for MPFF,¹⁶ hydroxyethylrutinosides,^{17,18} and GAC in wall of the kidney cortex.¹⁹ The latter would increase the thickness of the glycocalyx in patients with type 2 diabetes.²⁰ Improvement in plethysmographic parameters was shown with *Ruscus* extract,²¹ MPFF,²² and some other VADs.²³ Hemodynamic effects were also seen with GAC in patients with postthrombotic syndrome (PTS).²⁴ The cellular mechanisms underlying the properties of other venoactive drugs have not been clearly established.

Venous flow

As indicated in Chapter 1, unidirectional venous flow from lower limbs to the heart is secured by venous valve competence. Venous valves and wall are subjected to

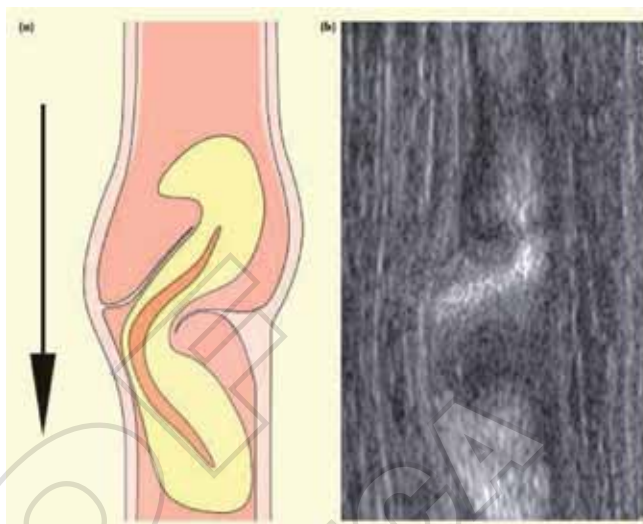

Figure 6.1B.—Incompetent venous valve. The valve sinus is distorted. The cusp above the dilatation is frozen and the adjacent cusp is prolapsed. The high-velocity retrograde streaming deviates laterally above a prolapsing cusp: (a) schematic and (b) B-flow ultrasound images. Courtesy of R J Lane.

many forces owing blood flow, of which the most important is shear stress that plays an important role in inflammation and development of chronic venous disease. Flow direction and blood viscosity are also part of the pathological changes that may occur in venous wall and valves.

This section will therefore focus on three aspects of flow: venous flow and venous valves, venous flow and shear stress and blood viscosity.

Venous flow and venous valves

Venous valves are not passive membranes that simply open and close the vessel lumen. The introduction of B-flow ultrasonography has allowed the observation of venous valves and blood flow in the area of the valve in undisturbed conditions (Figure 6.1A and B) Using B-flow imaging, Lurie and co-workers have proposed a new concept for the mechanism of venous valve closure and the role of the valve in the circulation.²⁵ Venous flow is normally pulsatile and separated into a proximally directed jet and a vertical flow into the sinus pocket behind the valve cusp; the vertical flow prevents stasis in the pocket and ensures that all surfaces of the valve are exposed to shear stress. Valve closure occurs when the pressure caused by the vertical flow exceeds the pressure on the luminal side of the valve leaflet due

to the proximally directed jet. Interestingly, foot movements, which increase the velocity of the jet, reduce the pressure on the luminal side of the valve leaflets and cause closure of the valve. Thus, minimal reflux occurs and endothelial surfaces are not generally exposed to reverse blood flow (see chapter 1).

Such hemodynamic events are predetermined by the shape and mechanical properties of the sinus and valve cusps, and constitute a self-sustained mechanism for competent valve operation.²⁵ Actually, vertical flow into the sinus pocket, which is mainstay in valve cycle, secures an adequate oxygenation of valve pockets, and thereby prevents thrombus formation. The shape of the valve orifice during the opening phase of the cycle allows the formation of organized flow patterns which conserve a significant amount of energy, thus accelerate blood flow and facilitate venous return.

In a rat model of arteriovenous fistula which represents an extreme and acute form of venous hypertension, exposing venous valve to continuous high pressure > 90mm Hg, valve destruction occurred within 6 weeks.²⁶ Exposed superficial veins were dilated by 25% compared with control ones, and their longitudinal sections showed reduced valve leaflet width and height. Granulocytes were infiltrated into these damaged valves. Treatment with MPFF significantly attenuated the reduction of valve height in pressurized veins, and markedly reduced the rate of retrograde blood flow at 3 weeks compared to controls. There was a trend to attenuate granulocyte infiltrate into exposed valves with MPFF. Compared to vehicle, MPFF treatment inhibited the expression of endothelial cell adhesion molecules P-selectin and ICAM-1, reduced leukocyte infiltration, and decreased the level of apoptosis in valves in a dose-dependent manner, suggesting that in the rat model of venous hypertension, MPFF attenuates alterations on valve shape and lowers subsequent hemodynamic disturbances. A decrease in leukocytes-mediated valve inflammation was seen in parallel. No other available drug has attenuated leukocyte-endothelial interaction, *in vivo*. Numerous *in vitro* experiments have shown that most VADs have scavenging properties towards free radicals.²⁷

Venous flow and shear stress

It has been shown that disturbed flow, and especially flow in the reverse direction or oscillatory, has pro-in-

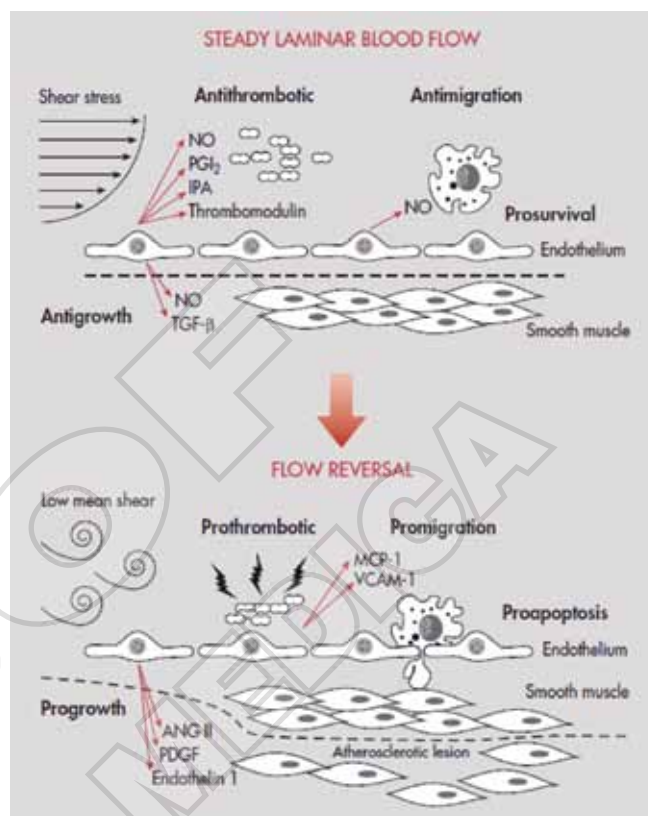

Figure 6.2.—Summary of contrasting effects of steady, laminar shear stress (upper panel) and turbulent or reversing shear stress (lower panel) on vessel walls. Abbreviations: ANG II, angiotension II; IPA, invasion protein antigen; MCP-1, monocyte chemotactic protein; NO, nitric oxide; PDGF, platelet-derived growth factor; PGI₂, prostacyclin I₂; TGF-β, transforming growth factor β; tPA, tissue plasminogen activator; VCAM-1, vascular cell adhesion molecule 1. Copyright American Heart Association.

flammatory action via promotion of an inflammatory endothelial phenotype. By contrast, pulsatile, laminar unidirectional flow produces shear stress that is transduced by endothelial cells and promotes the release of factors that reduce inflammation (Figure. 6.2).²⁸ Shear stress also acts on leukocytes themselves. Leukocytes respond to fluid shear stress by rapid retraction of pseudopods, the shedding of adhesion molecules and the detachment from the endothelial surface. On the other hand, conditions of low or zero flow and shear stress activate leukocytes and promote a shift towards an inflammatory state. Altered shear stress may be important in initial phases of inflammatory events in venous valves and walls and in maintaining leukocyte-mediated inflammatory reactions (Figure 6.3).

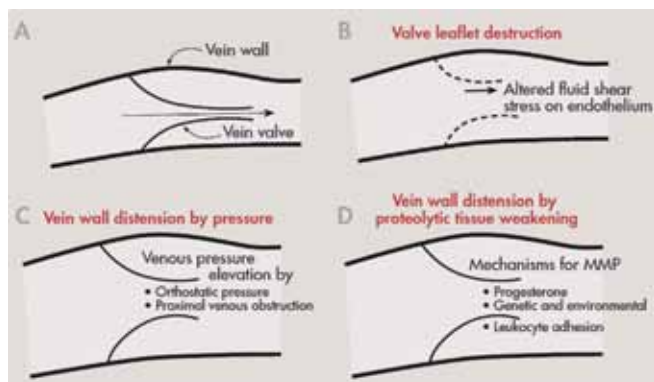

Figure 6.3.—A schematic diagram illustrating selected mechanisms that may control inflammation of the vein wall and valve leaflet (A). Valve leaflets may be subject to inflammatory damage by alteration in magnitude and direction of fluid shear stress on the endothelium (B). Venous valves may become unable to close their leaflets due to vein wall distension by elevated venous pressure (C), or by weakening of the vein wall due to proteolytic degradation of its extracellular matrix. Abbreviation: MMP, matrix metalloproteinases. Courtesy of G. Schmid-Schönbein

An indirect action of drugs is likely through prevention of valve damage, thereby improving or restoring normal blood flow, and allowing better oxygenation of valve pockets. All these elements are part of normalized shear stress.

Blood viscosity

Hemorheological changes are constant in CVD, appearing as a basic trait with increased blood viscosity due to plasma volume contraction and increased fibrinogen as a consequence of inflammation.²³ The presence of huge red cell aggregates in the vicinity of venules reduces blood flow and causes poor oxygen delivery from red cells. Erythrocyte aggregability and blood viscosity increase with the severity of the disease.

Some VADs limit red cell aggregation (*Ginkgo biloba*), decrease blood viscosity (MPFF, calcium dobesilate, GAC), and increase red cell velocity (MPFF).^{29,30}

Valves in small veins and venules

It is commonly believed that valves are absent in veins smaller than 2 millimeters in diameter. However, venous valves were first described in human digital skin in 1934 and have been found in several regions of the body.³¹ Most microvalves in lower limbs are present within channels less than 100 μm in luminal diameter.³² The role that microvalves play is still unclear and their location and arrangement in normal lower

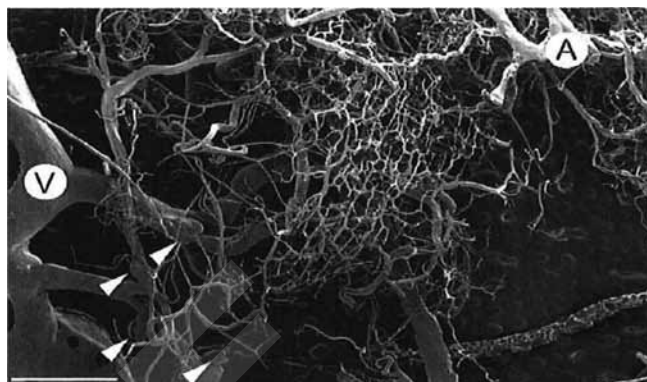

Figure 6.4.—Capillary bed network associated with an artery (A) and vein (V). Four 'microvalves' are visible (arrowheads). Scale bar= 2 mm. Copyright Clinical Anatomy

limbs suggest that they prevent blood flow into the capillary bed (Figure.6.4). This has been evidenced by Philips³³ who found no difference between lower limbs with venous ulcer and normal ones regarding the number and density of microvalves. However, microvalves in diseased limbs were stretched and incompetent allowing retrograde flow from large veins to dermal capillary bed. The hypotheses proposed by Vincent *et al.* are that degenerative changes in very small veins in leg skin may be related to the appearance of telangiectasiae, reticular veins and corona phlebectatica, and also that valve incompetence in both, larger proximal vessels and small superficial veins at microvalve level would account for severe skin changes in venous insufficiency.³⁴

Studies on the pathophysiology of CVD have not yet acknowledged that the chain of events is not limited to large veins including the saphenous veins but extends down to the venular level where valves and microvalves play an important role in venous hemodynamics. Such recent findings still need to be explored *in vivo* and the role of pharmacological treatments in protecting such structures to be determined.

Microcirculation

Microcirculation is the term used to describe vessels with mean internal diameter smaller than 100 within organs which are responsible for the distribution of blood within tissues. Capillary size in mammals ranges between 5-8 μm . The microcirculation also includes lymphatic capillaries and collecting ducts.

Alteration of interstitial capillaries and edema formation

The changes in venous hemodynamics that result in venous hypertension are transmitted into the microcirculation. Venous hypertension can result from valve incompetence of axial deep or superficial veins, perforating vein incompetence, venous obstruction, or a combination of them. These factors are exacerbated by muscle pump dysfunction in the lower extremity. Venous hypertension increases hydrostatic pressure in capillaries resulting in transcapillary filtration that exceeds lymphatic flow to contribute to interstitial edema. Venous hypertension slows blood flow in capillaries, prompting leukocyte adhesion to capillary endothelium and initiating an inflammatory reaction.¹ One theory holds that inflammation opens the gaps between endothelial cells via a mechanism involving vascular endothelial growth factor (VEGF), nitric oxide synthetase (NOS), and contraction of actin and myosin filaments present in endothelial cells.³⁵ The gaps would become very large, greatly raising capillary permeability to fluid, macromolecules, and allows extravasation of red blood cells, resulting in their flow into the interstitial space and in edema formation. Swollen endothelial cells with enlarged inter-endothelial spaces make the capillary lumen irregular and cause an increase on macromolecular permeability with plasma, red blood cells and fibrinogen leakage that could impair nutrient exchange.^{36,37} Sustained venous stasis and hypertension lead to chronic inflammation of the capillary bed and surrounding tissues and edema formation.^{38,39} Reduction of capillary density could cause trophic disorders and leg ulceration.⁴⁰ In experimental studies, MPFF improved microvascular reactivity and functional capillary density (number of capillaries with flowing red blood cells per unit of tissue) after ischemia/reperfusion.⁴¹ In experimental studies, MPFF induced a significant dose-related reduction in the increased permeability, and the non-micronized PFF was significantly less effective.⁴² The synergistic action of all flavonoid components of MPFF (diosmin, diosmetin, hesperidin, linarin and isorhoifolin) explains its high efficacy for reducing capillary permeability.⁴³

Pappas *et al.* observed that inter-endothelial gap junctions of capillaries from either the gaiter zone or thigh of CVI patients were not widened, and they proposed an alternative explanation involving formation of transendothelial channels for macromolecular transport.⁴⁴

Experimental *in vivo* models have been used to study the effect of drugs on the microcirculation. Microcirculatory preparations comprise hamster cheek pouch,

hamster or mouse skinfold, rat or hamster mesentery, rat, hamster or mouse cremaster, and others.⁴⁵ Numerous pharmacological trials have shown that VADs increase capillary resistance and reduce capillary filtration, resulting in prevention of capillary leakage. This has been evidenced for micronized purified flavonoid fraction (MPFF), rutosides, escin, Ruscus extract, proanthocyanidins and calcium dobesilate.²⁹

Several clinical trials, most of them controlled *versus* placebo or stockings, have evidenced the anti-edema efficacy of oral VADs such as MPFF, rutosides, horse chestnut seed extract, calcium dobesilate, proanthocyanidines and coumarin-rutin. In these trials, evaluation of the anti-edema efficacy was based on objective measures such as leg circumference assessment, strain-gauge plethysmography and water displacement. Other large-scale trials performed internationally on air-travel edema, on healthy volunteers or in patients with varicose veins or postthrombotic syndrome have shown the value of VADs in reducing leg edema. Results of meta-analyses have confirmed the anti-edema efficacy of such medications.²⁹

Results of Cochrane meta-analysis for main VADs showed significant treatment benefits for the VADs compared with placebo with no evidence of heterogeneity among studies for edema (RR 0.72, 95% CI 0.65; 0.81). In a recent meta-analysis of ten publications dated between 1975 and 2009 including a total of 1010 patients, for the benefits of MPFF, hydroxyethylrutoside, ruscus extracts and diosmin on edema reduction, the mean reduction in ankle circumference was -0.80 ± 0.53 cm with MPFF, -0.58 ± 0.47 cm with Ruscus extract, -0.58 ± 0.31 cm with hydroxyethylrutoside, -0.20 ± 0.5 cm with single diosmin, and -0.11 ± 0.42 cm with placebo.⁴⁶ The reduction in ankle circumference was significantly superior to placebo whatever the drug used ($P < 0.0001$). The comparison between MPFF, Ruscus extract and hydroxyethylrutoside on ankle reduction of edema was in favor of MPFF ($P < 0.0001$).⁴⁶

Alteration of skin capillaries and venous ulcer formation

Skin is the final target of chronic venous hypertension and of hemodynamic changes in veins. Clinical manifestations of alteration of skin capillaries are pigmentation, venous eczema, lipodermatosclerosis, atrophie blanche and eventually venous ulcer. Several mechanisms for the development of venous ulceration have been postulated,



TABLE 1.—Microcirculatory parameters in studied patients according to CEAP classification.

	FCD (cap/mm ²)	DDP (μm)	DCB (μm)	CD (μm)	CM (%)
Control	20.9 ± 6.1	111.4 ± 13.5	52.8 ± 8.8	8.1 ± 0.8	3.6 ± 5.5
C1	20.6 ± 4.8	125.1 ± 26.5	77.1 ± 31.6	8.7 ± 1.2	20.3 ± 12.8
C2	20.9 ± 6.6	141.0 ± 21.1	75.8 ± 17.9	9.7 ± 1.3	27.5 ± 17.7
C3	18.0 ± 4.4	50.5 ± 31.7	87.8 ± 26.9	9.1 ± 1.6	44.9 ± 32.6
C4	14.5 ± 4.5	169.5 ± 23.7	103.2 ± 35.4	9.5 ± 1.8	58.5 ± 28.7
C5	12.1 ± 8.2	223.9 ± 126.9	149.1 ± 56.3	11.1 ± 2.9	75.2 ± 37.0

FCD, Functional capillary density (number of capillaries with flowing red cells/mm²); CM, capillary morphology (% of abnormal capillaries); DDP, diameter of dermal papilla (to quantify edema); DCB, diameter of capillary bulk (to assess the degree of change, μm); CD, capillary diameter (to evaluate enlargement, μm). *P* < .05 compared with control values. Results expressed as mean ± SD.

of which the theory of “leukocyte trapping” is the most likely one,⁴⁷ although challenged today. It is hypothesized that the primary injury to the skin is extravasation of macromolecules, such as fibrinogen and α-macroglobulin, and red blood cells (pigmentation) into the dermal interstitium. Red blood cell degradation products and extravasation of interstitial protein are potent chemoattractants and presumably generate the initial inflammatory signal which results in leukocyte recruitment and migration into the dermis.¹ Pathologic events occur during leukocyte migration into the dermis and the end product is dermal fibrosis. One of the pathologic events is an increase in transforming growth factor beta-1 (TGF-β1), released by macrophages and mast cells or auto-induced by dermal fibroblasts. An increase in TGF-β1 causes an imbalance in tissue remodeling, which results in increased collagen synthesis and affects matrix metalloproteases (MMPs) as well as their tissue inhibitors (TIMPs). It is hypothesized that an imbalance in MMPs and their regulation may cause or contribute to venous ulcer formation.¹ A cascade of inflammatory events results in cutaneous changes which include skin hyperpigmentation caused by hemosiderin deposition and eczematous dermatitis. Fibrosis may develop in the dermis and subcutaneous tissue lipodermatosclerosis. There is an increased risk of cellulitis and leg ulceration. A linear relationship between ulceration rate and ambulatory venous pressure has been determined.⁴⁸ (see chapter 3).

Over the last ten years, the orthogonal polarization spectral (OPS) imaging technique used in the Cytoscan has allowed the study of alterations of skin capillaries in patients assigned C₁ to C₆ of the CEAP classification (Figure.3.22 in chapter 3). The Cytoscan has a small handheld probe which can be noninvasively applied to all body surfaces and evaluate microcirculatory

parameters such as functional capillary density (FCD, capillaries/mm²), diameter of dermal papilla (DDP, μm) to quantify edema, the largest diameter of the capillary bulk (DCB, μm) to assess its degree of change, capillary limb diameter (CD, μm) to describe diameter changes, and capillary morphology (CM, % of abnormal capillaries per field). It was demonstrated that FCD, DDP, DCB, CD and CM values were progressively altered from C₁ to C₆ patients and values in CVD patients were significantly different from these of healthy subjects (*P* < 0.05), (Table 6.1).⁵⁰

In 124 patients assigned CEAP C₃ to C₆, capillary morphologic changes were observed through capillaroscopy following pharmacological intervention over eight weeks consisting of *Ruscus aculeatus* (plant extract), hesperidin methylchalcone (HMC) and ascorbic acid, 100 mg. Severe pain, heaviness and cramps decreased starting from the second week until there were no symptoms by the end of treatment. Capillary-level effect was proportional to symptom decrease and showed 98% to 20% inter-capillary fluid decrease; 80% to 20% efferent loop thickening; 5% to 2% peri-capillary bed, and 5% to 4% mega-capillaries.⁴⁹

In a subsequent study,⁵¹ 55 female patients (85 legs), 25 to 57 years, with at least one limb classified as C_{2,s} or C_{2,3,s} (CEAP classification) were randomized to Cirkan [venotonic drug containing *Ruscus aculeatus* (plant extract), hesperidine methylchalcone (flavonoid) and vitamin C], graduated elastic compression stockings (GEC) or no treatment for four weeks. Ten healthy women age-matched were also investigated. Using orthogonal polarization spectral technique, measurements of FCD, CM, DDP, DCB and CD were obtained on the medial perimalleolar region and later analyzed using CapImage software. The CVD patients showed significant chang-

es on CD and CM compared with healthy subjects in agreement with previous findings.⁵⁰ On Cirkan-treated patients, CD decreased after four weeks on both limbs and CM improved on the left one suggesting an amelioration of the chronic hypertensive microangiopathy. No significant changes could be detected on other patient groups. These results confirmed the existence of microcirculatory dysfunction in early stages of CVD, probably due to post-capillary hypertension, and further support the venotonic action of Cirkan.⁵¹

There is evidence from five randomized controlled trials and a meta-analysis involving 723 patients assigned to CEAP class C₆, that MPFF was effective for healing venous ulcers when used as an adjunct to compression therapy and appropriate local therapy, particularly for ulcers that are large (>5 cm² in area) and/or persistent (>6 months' duration).⁵²

In 235 patients undergoing local treatment and compression bandaging, randomized to receive either GAC or matching placebo for three months, complete ulcer healing after 2 months was higher with GAC at 2 months ($p = 0.018$).⁵³

Other VADS such as horse chestnut seed extract and hydroxyrutosides failed to demonstrate superiority over compression in healing venous ulcer,⁵⁴ or in preventing ulcer recurrence.⁵⁵

Alteration of lymphatic vessels

The draining function of lymphatic vessels is very important. They are involved in the recirculation of lymphocytes and proteins, transport of microorganisms by lymph, and drainage of interstitial fluid to blood. The average human body weighing 65 kg contains 3 L of blood plasma and 12 L of interstitial fluid. Up to 8–12 L of afferent lymph are produced each day of which 4–8 L of ultra-filtrate are reabsorbed into the bloodstream in the lymphatic nodes. Lymphatic vessels transport 4 L of efferent lymph into the bloodstream daily. The concentration of proteins in plasma, interstitial fluid, afferent lymph, and efferent lymph is 70 g/L, 20–30 g/L, 20–30 g/L, and 60 g/L, respectively. The fluid turnover (including the volume of fluid reabsorbed in lymph nodes) reaches up to two-thirds of the total volume of interstitial fluid every 24 hours.⁵⁶ The skin on the lower extremities contains a denser and more extensive network of lymphatic capillaries than the skin of the upper

extremities.⁵⁷ Due to orthostatism, lower extremities have higher filtration pressure and influx of fluids, and it is thought that the capacity for lymph transport in the lower extremities is greater in order to compensate the higher influx of interstitial fluid caused by the effects of orthostatism and gravity.

Spontaneous contractility of lymphatic vessels is utilized in lymph transport. Regular contractions of lymph vessels, at a frequency of 2–4 per minute, were observed *in vitro*. Spontaneous contractions of prenodal lymphatic vessels have been observed in human legs, and these contractions were shown to drive the lymph.⁵⁸ Internal extensions of lymphatic endothelial cells act as valves and guarantee a one-way lymph flow.⁵⁶

In steady state, the extravasation of fluids and proteins from blood vessels is balanced by lymphatic drainage and return into the bloodstream. If microvascular filtration in blood capillaries and venules (as it is the case in advanced CVD) exceeds the lymphatic drainage for sufficiently long periods, edema occurs in afflicted areas by accumulation of tissue fluid in the interstitium. In addition, lymphatic dysfunction and structural damages to lymphatic network are associated to varicose veins, and subsequent lymph stasis and reduced lymph transportation lead to inflammation.⁵⁹ This is associated with lipid accumulation in the media of the diseased veins. Such accumulation of inflammatory lipids in the vein wall might further damage adventitial lymphatic vessels.⁵⁹

Pharmacological trials of oral pharmaceutical treatments encompassing coumarin and derivatives, hydroethylrutosides, calcium dobesilate, aescin extracts, 0-(beta-hydroxyethyl)-rutosides and MPFF found that such drugs may help lymphedema treatment by reducing protein and extracellular fluid accumulation,⁶⁰ stimulating lymph contractility and flow,⁶¹ and reducing protein concentration and fibrotic induration in tissues by stimulating proteolysis.^{62,63}

In the review of clinical trials by Moseley *et al.*⁶⁴ five studies investigated the effect of oral pharmaceuticals. Three studies investigated coumarin with conflicting results.^{65,66,63} Burgos *et al.* investigated two dosages, 90 mg ($n = 23$) and 135 mg ($n = 30$) over 12 months and showed at the end that both groups experienced similar reduction in percentage volume of the limb.⁶⁵ Loprizi *et al.* used a cross over design to investigate the 6-month phase of coumarin (400 mg) and 6 month phase of pla-

cebo (n = 138) and showed edema worsening in both treatment and placebo phases.⁶⁶ Casley-Smith *et al.* used the same cross over design as above and demonstrated that the amount of edema in the legs was reduced from 25% to 17% above normal and that nearly one third of the edema fluid was removed from the legs. During the six months of the placebo period, the amount of edema of the legs was unchanged from 24% above normal.⁶³

A fourth study investigated MPFF or placebo (n = 48) over six months and found that the treatment group experienced 7% volume reduction whilst the placebo group experienced volume increase of 10%. Both groups experienced significant reduction in reported discomfort and the treatment group also had a significant reduction in heaviness.⁶⁷

The last study investigated three capsules of *Ruscus aculeatus* and hesperidin methyl chalcone, (n = 27) compared with placebo (n = 30) over three months.⁶⁸ After the first month, both treatment and placebo groups experienced volume reductions of 1.2% and 0.5% respectively. By three months, the treatment group had an overall volume reduction of 12.9% whilst the placebo group had an increase of 2.5%. Both groups experienced improvements in heaviness and limb mobility.

The 0-(beta-hydroxyethyl)-rutosides were studied in a 6 month randomized, double-blind, cross-over trial performed on 26 patients with postmastectomy lymphedema of the arm, and 14 with lymphedema of the leg. The active drug significantly reduced the volume and circumference of the limbs. Patients reported increased comfort and freedom of movement, a lessening of their bursting pains, heaviness and tension, and an increased mobility of their limbs.⁶⁹

From the 15 selected trials of the effect of pharmacological treatment in the reduction of limb lymphedema, the authors of the last Cochrane review were not able to perform a meta-analysis due to the heterogeneity of study designs. Consequently they did not draw conclusions about the effectiveness of these drugs in reducing limb volume, pain, or discomfort in lymphedematous limbs.⁷⁰

Considering the number of patients with lymphedema in the Western Industrialized countries, no specific product has been created to satisfy the needs of lymphatic patients as the market is considered small. A new dedicated product for primary lymphedema, Robuvit, a wood extract of French Oak (*Quercus Robur*), now also

under evaluation for secondary (post surgical) lymphedema and lymphatic problems associated to venous insufficiency has been produced and tested. A recent study has shown promising results on swelling, extra-capillary protein accumulation, limb size and function and personal satisfaction.⁷¹

Hemodynamics and venous pain

Disturbed venous flow patterns and chronic venous inflammation are interlinked phenomena. It is thought that mediators resulting from disturbed blood flow and subsequent inflammation have an important role in venous pain occurrence. Proinflammatory mediators released locally as a result of hemodynamic changes and hypoxia can activate nociceptors located in the venous wall, between endothelial and smooth muscle cells of the media, and in the perivenous space, in close contact with the microcirculation.⁷² The fact that pain is not closely correlated with objective parameters of varicose vein remodeling, incompetent venous valves, and inflammation suggests that the primary activation site of venous and/or perivenous nociceptors may not happen in large venous vessels. In this regard, the hypothesis of local activation of nociceptors in venules and in the microcirculation, where contact between nerve endings, arterioles and capillaries is probably closer than on the macrovascular level, seems entirely plausible.⁷³ Edema which is the direct consequence of altered hemodynamics may also cause pain by the pressure it exerts on nerve endings.

Hemodynamics and symptomatic patients without clinical signs and pathophysiological anomalies (C_{0s} patients)

Patients complaining of “venous” symptoms, but who do not have any clinical signs, anatomical anomalies, or physiological disorders that can be identified using the current complementary investigations involved in the CEAP classification, are assigned to class C_{0s}, E_n, A_n, P_n. Such patients are not uncommon in practice, and the results of the recent international detection program (Vein Consult Program) indicated that almost 20% of the 91 545 screened adults were classified with CEAP clinical grade C_{0s}.⁷⁴ A thorough examination is required to exclude the association of these symptoms with oth-

er disorders using complex imaging or even invasive investigations. Pharmacological treatment with VADs and compression therapy are currently used to treat C_{0s} patients, but “evidence-based” results on “pure” C_{0s} patients are lacking.²⁹

Research interest has recently focused on possible chronic inflammatory processes that can affect large and small venous vessels and valves.^{26,28} Degenerative changes and incompetence in microvenous valves can create reflux into the microvenous networks in the skin, which may be involved in the development of the severe skin changes that are observed with CVD.³⁴ It is unknown if microvalve alterations could also be responsible for symptoms that appear early in the progression of the disease, particularly in the C_{0s} patients. Research is currently ongoing to determine the origin of the symptoms in C_{0s} patients.

Indications for venoactive drugs

The role of VADs in the prevention of the natural history of CVD remains to be determined: are all VADs able to prevent future morbidity? Research advances have led to an appreciation of the importance of chronic inflammatory processes throughout the course of the condition, in the valves and walls of veins of all sizes and also in the skin, leading towards the development of varicose veins and leg ulcers.

Currently available drugs directed towards preventing or limiting the inflammatory response at all stages of the condition may play a significant role in preventing or slowing the development and recurrence of troublesome outward manifestations. These pharmacological agents (not only VADs) would deserve detailed study.^{28,75}

CVD-related symptoms constitute the most important indication for venoactive drugs in patients at any stage of disease. There are insufficient data to specify those CEAP clinical classes for which the benefits will be greatest, but it is reasonable to assume that patients at all stages of the disease, and particularly at the early C_{0s} stage, may benefit.¹ However, symptoms respond to VADs treatment with variable success, resulting in improved quality of life.^{29,76} In the most recent guidelines for management of chronic venous disorders of the lower limbs, VADs were assigned grades of recommendation according to the strength of the clinical file: one

agent (MPFF) received a Grade 1A level of evidence for its effects on venous symptoms, then calcium dobesilate was graded 2A, escin extracts and HCSE 2B.²⁹ VADs have also proven effective against lower limb edema with variable impact.⁴⁶

In patients with CVI, VADs may be used in conjunction with open surgery, endovenous procedures including stenting, saphenous thermal or chemical ablation, compression therapy or a combination thereof.⁷⁷

References

- Perrin M, Ramelet AA. Pharmacological treatment of primary chronic venous disease: rationale, results and unanswered questions. *Eur J Vasc Endovasc Surg.* 2011;41(1):117-25.
- Hiebert LM, Wice SM, McDuffie NM, Jaques LB. The heparin target organ--the endothelium. Studies in a rat model. *Q J Med.* 1993;86(5):341-8.
- Ofori FA. Pharmacological actions of sulodexide. *Semin Thromb Hemost.* 1998;24(2):127-138.
- Catinella FP, Cunningham JN Jr, Srungaram RK, *et al.* The factors influencing early patency of coronary artery bypass vein grafts: correlation of angiographic and ultrastructural findings. *J Thorac Cardiovasc Surg* 1982; 83: 686-700.
- Khalil RA, van Breemen C. Sustained contraction of vascular smooth muscle: calcium influx or C-kinase activation? *J Pharmacol Exp Ther* 1988;244:537-42.
- Rang HP, Dale MM, Ritter JM, Flower RJ. Noradrenergic transmission (6th edition). *In* Rang HP, Dale MM, eds. *Rang and Dale's Pharmacology.* Churchill Livingstone, 2007. Pp.169-170.
- Bouskela E, Cyrino FZ, Marcelon G. Possible mechanisms for the venular constriction elicited by Ruscus extract on hamster cheek pouch. *J Cardiovasc. Pharmacol.* 1994 24(1):165-70.
- Rizzi A, Quaglio D, Vasquez G, *et al.* Effects of vasoactive agents in healthy and diseased human saphenous veins. *J Vasc Surg* 1998; 28: 855-61.
- Ibegbuna V, Nicolaidis AN, Sowade O, Leon M, Geroulakos G. Venous elasticity after treatment with Daflon 500 mg. *Angiology.*1997;48:45-9.
- Araujo D, Viana F, Osswald W. Diosmin therapy alters the *in vitro* metabolism of noradrenaline by the varicose human saphenous vein. *Pharmacol Res* 1991;24:253-6.
- Juteau N, Bakri F, Pomies JP, Foulon C, Rigaudy P, Pillion G, *et al.* The human saphenous vein in pharmacology: effect of a new micronized flavonoidic fraction (Daflon 500 mg) on norepinephrine induced contraction. *Int Angiol.* 1995;14 (3 Suppl 1): 8-13.
- Boudet C, Peyrin L. Comparative effect of tropolone and diosmin on venous COMT and sympathetic activity in rat. *Arch Int Pharmacodyn Ther* 1986;283:312-20.
- Araujo D, Gulati O, Osswald W. Effects of two venotropic drugs on inactivation and O methylation of catecholamines in an isolated canine vein. *Arch Int Pharmacodyn Ther.* 1985;277:192-202.
- Sirtori CR. Aescin: pharmacology, pharmacokinetics and therapeutic profile. *Pharmacol Res* 2001;44:183-93.
- Raffetto JD, Khalil RA. Ca(2+)-dependent contraction by the saponin escin in rat vena cava: implications in venotonic treatment of varicose veins. *J Vasc Surg.* 2011;54:489-96.
- Duperray B, Vierin J, Pacheco H. Pharmacokinetics and biochemical pharmacology of diosmin in animals. *In* Tesi M, Dormandy JA, eds. *Superficial and deep venous diseases of the lower limbs.* Torino: PanMinerva Medica;1984.
- Patwardhan A, Carlsson K, Poullain JC, Taccon A, Gerentes I. The affinity of troxerutin for the venous wall measured by laser scanning microscopy. *J Cardiovasc Surg (Torino).* 1995;36:381-5.

18. Carlsson K, Patwardhan A, Poullain JC, Gerentes I. Transport and localization of troxerutin in the venous wall. *J Mal Vasc*. 1996;21 Suppl C:270-4.
19. Ruggeri A, Guizzardi S, Franchi M, Morocutti M, Mastacchi R. Pharmacokinetics and distribution of a fluoresceinated glycosaminoglycan, sulodexide, in rats. Part II: Organ distribution in rats. *Arzneimittelforschung* 1985;35(10):1517-9.
20. Broekhuizen LN, Lemkes BA, Mooij HL, Meuwese MC, Verberne H, Holleman F, *et al*. Effect of sulodexide on endothelial glycocalyx and vascular permeability in patients with type 2 diabetes mellitus. *Diabetologia* 2010;53(12):2646-55.
21. Allaert FA, Hugue C, Cazaubon M, Renaudin JM, Clavel T, Escourrou P. Correlation between improvement in functional signs and plethysmographic parameters during venoactive treatment (Cyclo 3 Fort). *Int Angiol*. 2011;30:272-7.
22. Barbe R, Amiel M. Pharmacodynamic properties and therapeutic efficacy of Dafflon 500 mg. *Phlebology* 1992; 7 Suppl. 2: S41-4.
23. Boisseau MR. Pharmacology of venotonic drugs: Current data on the mode of action. *Angeiologie*. 2000;52:71-7.
24. Cospite M, Milio G, Ferrara F, Cospite V, Palazzini E. Haemodynamic effects of Sulodexide in Post-Thrombophlebitic Syndromes. *Acta Therapeutica* 1992;18:149-61.
25. Lurie F, Kistner RL, Eklof B, Kessler D. Mechanism of venous valve closure and role of the valve in circulation: a new concept. *J Vasc Surg* 2003;38(5):955-61.
26. Bergan JJ, Pascarella L, Schmid-Schönbein G. Pathogenesis of primary chronic venous disease: insights from animal models of venous hypertension. *J Vasc Surg*. 2008;47:183-92.
27. Janssens D, Delaive E, Houbion A, Eliaers F, Remacle J, Michiels C. Effect of venotropic drugs on the respiratory activity of isolated mitochondria and in endothelial cells. *Br J Pharmacol*. 2000;130:1513-24.
28. Bergan JJ, Schmid-Schönbein G, Coleridge-Smith P, Nicolaides A, Boisseau M, Eklof B. Chronic venous disease. *N Engl J Med*. 2006; 355:488-98.
29. Nicolaides A, Kakkos S, Eklof B, Perrin M, Nelzen O, Neglen P. Management of chronic venous disorders of the lower limbs. Guidelines according to scientific evidence. *Int Angiol* 2014;33(2):111-260.
30. Harenberg J. Review of pharmacodynamics, pharmacokinetics, and therapeutic properties of sulodexide. *Med Res Rev* 1998;18(1):1-20.
31. Caggiati A, Phillips M, Lametschwandtner A, Allegra C. Valves in small veins and venules. *Eur J Endovasc Surg* 2006, 32(4), 447-52.
32. Phillips MN, Jones GT, van Rij AM, Zhang M. Micro-venous valves in the superficial veins of the human lower limb. *Clin Anat* 2004, 17(1):55-60.
33. Phillips MN. Anatomy of microvenous valves of normal and venous ulcerated lower limbs. PhD thesis, University of Otago, Dunedin (New Zealand), 2004.
34. Vincent JR, Jones GT, Hill GB, van Rij AM. Failure of microvenous valves in small superficial veins is a key to the skin changes of venous insufficiency. *J Vasc Surg* 2011;54(6suppl):62S-9S.
35. Levick JR. An introduction to Cardiovascular Physiology. Oxford, UK: Butterworth Heinemann Ltd, 1990.
36. Burnand KG, Whimster I, Naidoo A, Browse NL. Pericapillary fibrin in the ulcer-bearing skin of the leg: the cause of lipodermatosclerosis and venous ulceration. *Br. Med. J*. 1982; 285 (6348):1071-2.
37. Cheate TR, Sarin S, Smith PDC, Scurr JH. The pathogenesis of skin damage in venous disease: a review. *Eur J Vasc Surg* 1991;5(2):115-23.
38. Schmid-Schönbein GW, Takase S, Bergan JJ. New advances in the understanding of the pathophysiology of chronic venous insufficiency. *Angiology* 2001; 52 Suppl1:S27-34.
39. Agren MS, Eaglestein WH, Ferguson MJW, Harding KG, Moore K, Saarialho-Kere UK, Schultz GS. Causes and effects of the chronic inflammation in venous leg ulcers. *Acta Derm. Venereol Suppl* 2000; 210:3-17.
40. Nicolaides AN. Investigation of chronic venous insufficiency. A consensus statement. *Circulation*. 2000; 102(20):E126-63.
41. Bouskela E, Cyrino FZ, Lerond L. Effects of oral administration of different doses of purified micronized flavonoid fraction on microvascular reactivity after ischaemia/reperfusion in the hamster cheek pouch. *Br J Pharmacol* 1997 122(8):1611-6.
42. Cyrino FZGA, Bottino DA, Lerond L, Bouskela E. Micronization enhances the protective effect of purified flavonoid fraction against postischaemic microvascular injury in the hamster cheek pouch. *Clin. Exp. Pharmacol. Physiol* 2004; 31(3):159-62.
43. Paysant J, Sansilvestri-Morel P, Bouskela E, Verbeuren TJ. Different flavonoids present in the micronized purified flavonoid fraction (Dafflon® 500 mg) contribute to its anti-hyperpermeability effect in the hamster cheek pouch microcirculation. *Int Angiol* 2008;27:81-5.
44. Pappas P, Lal BK, Padberg FT Jr, Zickler RW, Duran WN. Pathogenesis of varicose veins and cellular pathophysiology of chronic venous insufficiency. In Gloviczki P, ed. *Handbook of Venous Disorders: Guidelines of the American Venous Forum*. 3rd ed. London, UK: Hodder Arnold; 2009, pp.56-69.
45. Virgini-Magalhaes CE, Bottino DA, Bouskela E. Microcirculation and chronic venous insufficiency: from production of pharmacological models to discovery of new therapies. *Phlebology* 2001;35:16-9.
46. Allaert FA. Meta-analysis of the impact of the principal venoactive drugs agents on malleolar venous edema. *Int Angiol* 2012;31(4):310-5.
47. Coleridge Smith PD, Thomas P, Scurr JH, Dormandy JA. Causes of venous ulceration: a new hypothesis. *Br Med J* 1988;296(6638):1726-7.
48. Nicolaides A, Hussein MK, Szendro G, Christopoulos D, Vasdekis S, Clarke H. The relation of venous ulceration with ambulatory venous pressure measurements. *J Vasc Surg* 1993;17(2):414-9.
49. Aguilar Peralta GR, Arévalo Gardoqui J, Llamas Macías FJ, Navarro Ceja VH, Mendoza Cisneros SA, Martínez Macías CG. Clinical and capillaroscopic evaluation in the treatment of chronic venous insufficiency with Ruscus aculeatus, hesperidin methylchalcone and ascorbic acid in venous insufficiency treatment of ambulatory patients. *Int Angiol* 2007;26(4):378-84.
50. Virgini-Magalhaes CE, Porto CL, Fernandes FF, *et al*. Use of microcirculatory parameters to evaluate chronic venous insufficiency. *J Vasc Surg* 2006;43(5):1037-44.
51. Lascasas-Porto CL, Milhomens AL, Virgini-Magalhaes CE, Fernandes FF, Sicuro FL, Bouskela E. Use of microcirculatory parameters to evaluate clinical treatments of chronic venous disorder (CVD). *Microvasc Res* 2008;76(1):66-72.
52. Coleridge-Smith P, Lok C, Ramelet AA. Venous leg ulcer: a meta-analysis of adjunctive therapy with micronized purified flavonoid fraction. *Eur J Vasc Endovasc Surg* 2005;30(2):198-208.
53. Coccheri S, Scodotto G, Agnelli G, Aloisi D, Palazzini E, Zamboni V. Randomised, double blind, multicentre, placebo controlled study of sulodexide in the treatment of venous leg ulcers. *Thromb Haemost* 2002;87(6):947-52.
54. Ottillinger B, Greeske K. Rational therapy of chronic venous insufficiency—chances and limits of the therapeutic use of horse chestnut seeds extract. *BMC Cardiovasc Disord* 2001;1:5.
55. Wright DDI, Franks PJ, Blair SD, Backhouse CM, Moffatt C, McColm CN. Oxeerutins in the prevention of recurrence in chronic venous ulceration: randomised controlled trial. *Br J Surg* 1991;78(10):1269-70.
56. Rovenská E, Rovenský J. Lymphatic vessels: structure and function. *Isr Med Assoc J* 2011;13(12):762-8.
57. Stanton AW, Patel HS, Levick JR, *et al*. Increased dermal lymphatic density in human leg compared with forearm. *Microvasc Res* 1999;57(3):320-8.
58. Olszewski WL, Engeset A. Intrinsic contractility of prenodal lymph vessels and lymph flow in human leg. *Am J Physiol* 1980;239(6): H775-83.
59. Tanaka H, Zaima N, Sasaki T, Yamamoto N, Sano M, Konno H, Setou M, Unno N. Loss of lymphatic vessels and regional lipid accumulation is associated with great saphenous vein incompetence. *J Vasc Surg* 2012;55(5):1440-8.
60. Roztocil K, Pretovsky I, Olivia I. The effects of hydroethylrutosides on capillary filtration rate in the lower limbs of man. *Eur J Clin Pharm* 1977;11(6):435-8.

61. Clement DL. Management of venous edema: Insights from an international task force. *Angiology* 2000;51(1):13-7.
62. Knight KR, Khazanchi RK, Pederson WC, McCann JJ, Coe SA, O'Brien BM. Coumarin and 7-hydroxycoumarin treatment of canine obstructive lymphoedema. *Clinic Sci* 1989; 77(1):69-76.
63. Casley-Smith JR, Morgan RG, Piller NB. Treatment of lymphedema of the arms and legs with 5,6-benzo-alpha-pyrone. *N Engl J Med* 1993;329(16):1158-63.
64. Moseley AL, Carati CJ, Piller NB. A systematic review of common conservative therapies for arm lymphoedema secondary to breast cancer treatment. *Annals of Oncology* 2007;18(4):639-46.
65. Burgos A, Alcaide A, Alcoba C *et al.* Comparative study of the clinical efficacy of two different coumarin dosages in the management of arm lymphedema after treatment for breast cancer. *Lymphology* 1999; 32(1):3-10.
66. Loprinzi CL, Kugler JW, Sloan JA, Rooke TW, Quella SK, Novotny P, Mowat RB, Michalak JC, Stella PJ, Levitt R, Tschetter LK, Windschitl H. Lack of effect of coumarin in women with lymphedema after treatment for breast cancer. *N Engl J Med* 1999;340(5):346-50.
67. Pecking AP, Fevrier B, Wargon C, Pillion G. Efficacy of Daflon 500 mg in the treatment of lymphedema (Secondary to conventional therapy of breast cancer). *Angiology* 1997;48(1):93-8.
68. Cluzan RV, Alliot F, Ghabboun S, Pascot M. Treatment of secondary lymphedema of the upper limb with Cyclo 3 Fort. *Lymphology* 1996;29(1):29-35.
69. Piller NB, Morgan RG, Casley-Smith JR. A double-blind, cross-over trial of O-(beta hydroxyethyl)-rutosides (benzo-pyrone) in the treatment of lymphoedema of the arms and legs. *Br J Plast Surg* 1988;41(1):20-7.
70. Badger C, Preston N, Seers K, Mortimer P. Benzo-pyrone for reducing and controlling lymphoedema of the limbs. *Cochrane Database Syst Rev* 2004;(2):CD003140.
71. Belcaro G, Dugall M, Hu S, Ledda A, Ippolito E. French Oak Wood (*Quercus robur*) Extract (Robuvit) in Primary Lymphedema: A Supplement, Pilot, Registry Evaluation. *Int J Angiol* 2015;24(1):47-54.
72. Vital A, Carles D, Serise JM, Boisseau MR. Evidence for unmyelinated C fibers and inflammatory cells in human varicose saphenous veins. *Int J Angiol* 2010;19(2):e73-7.
73. Danziger N. Pathophysiology of pain in venous disease. *J Mal Vasc* 2007;32(1):1-7.
74. Rabe E, Guex JJ, Puskas A, Scuderi A, Fernandez Quesada F and VCP coordinators. Epidemiology of chronic venous disorders in geographically diverse populations: results from the Vein Consult Program. *Int Angiol* 2012;31 (2):105-15.
75. Mannello F, Ligi D, Raffetto JD. Glycosaminoglycan sulodexide modulates inflammatory pathways in chronic venous disease. *Int Angiol* 2014;33(3):236-42.
76. Perrin M, Ramelet AA. Efficacy of venoactive drugs in primary chronic venous disease : survey of evidence, synthesis, and tentative recommendations. *In* JJ Bergan, Bunke-Planquette N eds. *The Vein Book*. 2nd ed. London, UK: Elsevier;2013. pp.514-27.
77. Lyseng-Williamson A, Perry CM. Micronised purified flavonoid fraction. A review of its use in chronic venous insufficiency, venous ulcers and haemorrhoids. *Drugs* 2003; 63:71-100.

Chapter 7.

Hemodynamic Effects of Abolition of Reflux in Superficial, Perforating or Deep Veins

Introduction

The goal of treatment for valvular incompetence of superficial, perforating and deep veins in patients with

varicose veins and those with more advanced chronic venous insufficiency (CVI) is to relieve symptoms by improving venous hemodynamics. Clinical improvement is frequently accompanied by measurable changes in ambulatory venous pressure, venous reflux and calf muscle pump function. These parameters have been used as surrogate endpoints for efficacy of treatment.

There has been tremendous progress for treating reflux in superficial and perforating veins in recent years with widespread use of minimally invasive therapies like radiofrequency ablation (RF), endovenous laser treatment (EVLT) and foam sclerotherapy. And even more recent, less invasive treatment modalities, the so-called "Non-Tumescent, Non-Thermal" (NTNT) methods have been introduced.¹ These include such innovations as mechanic-chemical ablation (MOCA),² cyanoacrylate adhesive,³ and manufactured polydocanol foam.^{4, 5}

In addition, conservative surgery such as Muller Phlebectomy,⁶ CHIVA,^{7, 8} and ASVAL⁹ added a new perspective for eliminating reflux. A complete analysis of their effect on reflux is presented in Chapter 8 to which the reader is referred explicitly to avoid useless overlap.

Surgical correction of deep venous reflux has also progressed, although an effective, minimally invasive procedure to correct deep vein valvular incompetence is still needed.

This chapter will discuss the hemodynamic effects of abolition of reflux in the superficial, perforating and deep venous systems using different strategies.

Abolition of Superficial Reflux

Abolition of reflux in limbs with isolated saphenous vein reflux

Reports on hemodynamic results after ablation of the incompetent great saphenous vein (GSV) differ between patients with isolated superficial vein incompetence and patients with associated incompetent perforating or incompetent deep veins.

The RELACS study was a randomized controlled trial (RCT) in which 185 patients were treated by EVLT and 161 with high ligation and stripping of the GSV to just below knee (HLS).¹⁰ Venous refilling time (VRT) was assessed by digital photoplethysmography (PPG).¹¹ The VRT normalized in 86% after EVLT and in 76%

after HLS at one year and 82% after EVLT and in 71% after HLS at two years. Ultrasound-detected sapheno-femoral junction (SFJ) reflux occurred significantly more frequently after EVLT than after HLS at two years (17.8% vs 1.3%; $P < .001$).

Two prospective studies evaluated hemodynamic changes in patients who underwent HLS to the knee and had an incompetent and untreated below-knee segment of the GSV (BK-GSV). In the first study, Blomgren *et al.*¹² reported that reflux in the BK-GSV resolved in 34% of limbs (17/50) at two months and 44% (22/50) at two years, and that 18% of limbs with a normal SFJ before operation developed reflux after two years. Unfortunately, some patients with perforating vein incompetence were also included in this study. In the other study, van Neer *et al.*¹³ reported that reflux in the BK-GSV increased from 81% before HLS to 84% at six months and to 91% at two years after surgery. However, reflux in the posterior calf tributary of the GSV appeared to lessen at 67%, 64% and 59% for the same time intervals.

Clinical data suggest that a residual refluxing BK-GSV leads to increasing symptoms and more severe signs, with a greater likelihood for residual and recurrent varicose veins.¹⁴ This assumption was confirmed by a RCT comparing surgery and EVLT in 280 patients with GSV reflux where the clinical recurrence rate at one year was significantly lower after EVLT than after surgery (4.0% vs. 20.4%, $P < .001$) while 52% (12/23) of recurrent varicose veins after surgery were related to an incompetent BK-GSV.¹⁵ These results questioned the widely accepted and practiced principle of stripping the GSV to the knee level only without some form of further treatment to the BK segment.

In a prospective study, 13 patients with great saphenous incompetence were treated with RF ablation.¹⁶ and duplex ultrasound and foot volumetry were used to measure venous function during follow-up including the expelled volume (EV), refilling rate and total foot volume (FV). Saphenous reflux was either eliminated or reduced after operation and venous function improved significantly at six months. Expelled volume (EV) increased from 13.6 (range 7.6-26.5) to 16.2 (range 9.7-28.4) ($P=0.05$) and expelled volume related to foot volume decreased from 3.4 (range 1.2-8.2) to 2.5 (range 0.8-4.9) ($P=0.019$). However, these differences were no longer significant at one year.

Park *et al.*¹⁷ reported early hemodynamic results us-

ing air-plethysmography (APG) in patients treated for isolated superficial reflux in 1756 limbs. Ninety percent of the limbs were treated with HLS and phlebectomy, 7% with external banding valvuloplasty of the GSV using Dacron-tailored mesh and phlebectomy and 3% were treated with RF ablation and phlebectomy. All hemodynamic variables improved significantly at one month after surgery: venous volume (VV), venous filling index (VFI), and residual volume fraction (RVF) were reduced by 25.2%, 71.5%, and 29.9% respectively, and EF increased by 20.3% ($P < .001$). Reduction of VV, VFI and RVF was slightly greater in the HLS and RF groups than in the valvuloplasty group ($P < .001$) but there was no difference of EF increase among the three groups. Improvement in the overall venous function was associated not only with abolition of venous reflux but also with improved calf muscle pump performance.

In addition to surgery and thermal ablation, treatment of incompetent GSVs with sclerotherapy is also a good and cost effective treatment option.¹⁸ The efficacy of foam sclerotherapy has been demonstrated in several case control studies and RCTs in recent years.¹⁹⁻²⁸ The VEDICO study²⁹ included 800 patients treated by different modalities: normal and high dose liquid sclerotherapy, multiple ligations, stab avulsions, foam sclerotherapy and ligation followed by sclerotherapy. A decrease in AVP (the lowest pressure reached during exercise) and increase in VRT was similar in the different groups at 10 years. This RCT concluded that when correctly performed, all treatments may be similarly effective although foam sclerotherapy was more effective than liquid sclerotherapy. In one RCT comparing foam and liquid sclerotherapy, the resolution rate for GSV reflux was 69% for foam *versus* 27% for liquid at three months ($P < .0001$),²² and in another it was 53% *versus* 12%, respectively at two years ($P < .0001$).²³ In RCTs that compared foam sclerotherapy with surgery and/or thermal ablation, reflux resolution rates were 94.2% for EVLT, 95.2% for RF, 83.7% for foam sclerotherapy and 95.2% for surgery at one year ($P < .001$)²⁵ and 65% for foam and 79% for surgery at two years ($P = .003$).^{26, 29} In another report, VRT was measured by PPG in 246 patients with symptomatic superficial venous reflux treated by foam sclerotherapy and median VRT improved from 11 seconds to 31 seconds at six months ($P < 0.0005$) while hemodynamic improvement correlated

with symptom relief.³⁰ Other published results have demonstrated immediate GSV occlusion in 80-95% of patients after three injections.^{29, 31-34} Early and mid-term results revealed a recurrence rate of approximately 20% at three years but repeat sclerotherapy was a simple and effective treatment for recurrence.³⁵

Abolition of reflux in limbs with superficial and perforating vein reflux

There is increasing evidence that treating superficial reflux will have an effect on perforating vein reflux as well so that abolition of reflux in the superficial system may eliminate reflux in perforating veins (PVs). However, in one study this was not the case in patients with associated deep venous reflux.³⁶ Two studies showed that HLS had a profound effect on global lower limb venous hemodynamics with reduced total venous overload of the limb associated with reversed perforating vein incompetence (IPV). Mendes *et al.*³⁷ studied 24 limbs with both superficial and perforating vein reflux and a normal deep venous system and found that 71% of IPVs became competent or were absent at three months after HLS to the knee with phlebectomy. All APG parameters improved significantly; VFI decreased from 6.0 ± 2.9 ml/s to 2.2 ± 1.3 ml/s, EF increased from 56% to 62%, and RVF decreased from 40% to 28% after surgery. In addition, patients with increasing numbers of IPVs had higher VFI after surgery. Blomgren *et al.*¹² studied 64 limbs with both superficial and perforating vein reflux where IPVs were not treated after HLS in 42 limbs. IPV resolved in 23 (55%) of these limbs at two months and 25 (60%) at two years. The fraction of legs without IPVs in the calf after two years was not significantly lower in the remainder where IPVs had been interrupted.

In the randomized ESCHAR trial, there were significantly fewer limbs with residual or newly developed IPVs of the calf in patients treated with compression and HLS compared with those managed by compression alone (59/115 vs. 44/104, $P = 0.001$; 12/104 vs. 36/131, $P = 0.003$).³⁸ Two other RCTs have shown that following ablation of superficial incompetence, only 35-40% of IPVs become normal and that new IPVs appear over time.^{39, 40} Further, some 6-8% of ulcer patients show only isolated IPVs as a possible cause for their ulcers.⁴¹

In summary, surgical correction of superficial reflux may indeed abolish reflux in many existing and decrease the number of new calf IPVs.

Abolition of reflux in limbs with deep venous reflux

There is low quality evidence that ablation of superficial reflux in limbs with associated segmental deep vein reflux restores deep vein competence by reducing venous overload.⁴²⁻⁴⁸ It is postulated that segmental deep vein reflux is associated with drainage into an incompetent GSV through incompetent thigh perforating veins and that HLS destroys this pathway so that blood in the deep veins then stops refluxing at the first competent valve encountered distally.

Ting *et al.*⁴⁴ evaluated 102 limbs with combined superficial and deep vein incompetence (DVI) by APG after HLS and found that the VFI decreased from 5.99 ± 3.99 ml/s to 1.82 ± 1.21 ml/s, the EF increased from 48% to 53% and the RVF decreased from 50% to 36% after surgery. EF improved but did not normalize in this series. The proportion of limbs with DVI on duplex ultrasound scanning at more than one site decreased from 70% to 44% and the mean number of sites with DVI significantly decreased from 2.14 ± 0.96 to 1.52 ± 1.21 after surgery ($P < .001$).

Adam *et al.*⁴⁵ studied patients with combined superficial and segmental deep venous reflux and demonstrated that HLS corrected deep venous reflux in almost half of 53 limbs at three months, and in 75% (12/16) of femoral veins compared with 38% (14/37) of below knee popliteal vein or gastrocnemius veins ($P = .018$). Segmental deep venous reflux resolved in 49% (19/39) of limbs with chronic venous ulceration, and ulcers healed in 77% (30/39) of the limbs at 12 months. Segmental deep vein reflux resolved in 47% (14/30) of limbs with a healed ulcer which included 78% (7/9) of limbs with femoral vein and 33% (7/21) with below knee popliteal vein or GSV reflux ($P = 0.046$).

Using venous refill times (VRTs) measured by PPG, Gohel *et al.*⁴⁶ found that HLS abolished deep venous reflux in 45% of limbs with segmental deep venous reflux and 18% with axial deep venous reflux. Of 214 legs investigated, 112 were treated with compression and 102 with compression plus surgery. Saphenous surgery abolished deep reflux in ten of 22 legs with segmental deep reflux and three of 17 with total deep reflux. Over-

all median (range) VRT increased from 10 (3-48) to 15 (4-48) seconds at one year after surgery ($P < 0.001$). Preoperative change in VRT after applying a below-knee tourniquet correlated with change in VRT following surgery. Limbs with resolved deep venous reflux showed a greater improvement in VRT after HLS than limbs with residual deep venous reflux.

Dix *et al.*⁴⁷ reported 42 limbs with combined superficial and deep vein incompetence all treated by HLS. Pressure relief indices (PRI) were calculated from ambulatory venous pressures (AVP) as an overall assessment of venous function. Segmental DVI resolved in 11/21 (52%) limbs after HLS compared with 6/21 (29%) with multisegment reflux, and median PRI improved from 319 before to 1,300 after operation ($P < .001$). The authors concluded that HLS can improve segmental DVI and PRI in properly selected patients. These hemodynamic results favor HLS in limbs with combined superficial and segmental deep reflux, and deep vein reconstruction may not need to be considered in these patients.

In contrast, other authors reported unfavorable results for abolition of deep venous reflux after HLS. Padberg *et al.*⁴⁹ studied 11 limbs by APG and found that VFI decreased from 12 ± 5 ml/s to 2.7 ± 1 ml/s, EF increased from $43\% \pm 11$ to $59\% \pm 13$ and the RVF decreased from $56\% \pm 15$ to $33\% \pm 16$ one month after HLS, suggesting a significant reduction in deep reflux and significant improvement of calf pump function, but that deep venous reflux was resolved in only 3 limbs (27%).

Puggioni *et al.*⁵⁰ prospectively analyzed 38 lower limbs, 17 with axial and 21 with segmental deep venous reflux, to investigate the effects of GSV ablation on coexisting primary deep axial vein reflux compared with segmental vein reflux alone. The total number of incompetent segments was 59 and follow-up ranged from two weeks to 38 months. The total reflux resolution rate was about one third (19/59), similar between extremities with axial reflux and segmental reflux (30% vs. 36%), but femoral vein reflux was seldom corrected in extremities with axial reflux compared with those having segmental reflux.

In a study by Marston *et al.*,⁵¹ significant improvement in VFI was documented after EVLT for 75 limbs with both deep and superficial venous reflux. Maximal reflux velocity (MRV) was measured in the popliteal and femoral veins and VFI was significantly more

improved if MRV was less than 10 cm/s compared to limbs with MRV greater than 10 cm/s. In 35 limbs with deep venous reflux in the common femoral vein (CFV), the mean VFI decreased significantly from 6.54 ± 3.9 ml/s to 2.2 ± 1.9 ml/s, and in 40 limbs with deep venous reflux in the femoral and/or popliteal veins, VFI significantly improved from 6.2 ± 3.8 ml/s to 3.3 ± 3.0 ml ($P < .001$). The authors concluded that patients with deep venous reflux in the femoral and/or popliteal veins were less likely to completely correct their venous hemodynamics as measured by VFI.

Abolition of reflux in both superficial and perforating veins

Subfascial endoscopic perforator surgery (SEPS) greatly enhanced our ability to study clinical and hemodynamic results following perforating vein ablation in patients with CVI.^{48, 52-56}

In a randomized study by Tawes *et al.*,⁵⁶ 51 patients with C4 class CVI were allocated to two treatment arms, a SEPS alone group and an HLS group. The SEPS group had significant improvement in venous refilling time (VRT) to normal values (34.4 ± 10.3 s vs. 11.8 ± 4.0 s), compared with HLS (19.6 ± 13.8 s vs. 10.8 ± 8.9 s, $P < .02$), and a significant decrease of 65% in AVP measurements in the SEPS group compared with preoperative values, but 33% decrease only in the HLS group. These results supported the effective use of reflux surgery in advanced CVI. However, patients with deep venous reflux were mixed in this study and the number was higher in the SEPS group.

In another prospective study of 53 limbs in 47 patients who underwent SEPS with concomitant HLS for advanced primary CVI of whom 64% had active venous ulcers,⁴⁸ venous hemodynamics measured by APG improved significantly after the procedure with postoperative VFI decrease from 8.4 ± 6.3 ml/s to 3.0 ± 3.5 ml/s at one month and to 2.7 ± 2.6 ml/s at one year; EF increase from 44% to 49% and to 54% respectively, and RVF decrease from 48% to 42% and to 35% respectively. The proportion of limbs with femoral vein incompetence decreased from 68% to 28% at one month and to 32% at one year while the proportion of limbs with DVI at more than one site also decreased from 42% to 15% and to 12% respectively. The cumulative ulcer healing was 85% at three months and 97% at six months. Con-

comitant SEPS and HLS in this study were effective in reducing deep venous reflux and resulted in hemodynamic and clinical improvements in patients with advanced primary CVI.

In a retrospective study by Rhodes *et al.*,⁵⁷ improved calf muscle pump function was demonstrated by post-operative strain gauge plethysmography (SGP) within six months after SEPS when performed together with HLS in 77% of the limbs. Refill volume (RV) increased from 0.27 ± 0.06 to 0.64 ± 0.10 mL/100 ml of tissue ($P < .01$); venous incompetence improved as evidenced by a refill time increase from 7.71 ± 1.20 s to 16.71 ± 1.98 s after exercise ($P < .001$) and a decrease in RV from 3.23 ± 0.19 to 2.63 ± 0.15 mL/100 mL tissue after passive drainage ($P < .01$). It should be noted that perforating vein incompetence was defined as outward flow longer than 0.3 seconds in duration and deep and superficial reflux was defined as retrograde flow for more than 1.0 seconds in this study.⁵⁴

Abolition of deep venous reflux

Valve reconstructive surgery can involve internal valvuloplasty, external valvuloplasty, external valve banding, transposition of the vein, axillary/brachial vein transplantation and creation of neovalve (Maleti technique)⁵⁸ or non-autologous artificial venous valves.

There are two randomized studies comparing deep vein reconstructive surgery to HLS. Belcaro *et al.*⁵⁹ reported 22 patients treated with external valvuloplasty of the femoral vein using limited anterior plication (LAP) technique (LAP group), compared with HSL in another 22 patients. At 10 years, AVP was significantly lower (52 ± 2 mmHg vs. 62 ± 5 mmHg for HLS group, 45 ± 6 mmHg vs. 61 ± 6 mmHg for LAP group, $P < 0.05$), and RT was longer (13 ± 5 s vs. 11 ± 5 s for HLS group, and 17 ± 3 s vs. 11 ± 4 s for LAP group, $P < 0.05$). Both values of AVP and RT in the LAP group were significantly better than those in the HLS group. There was no femoral vein incompetence in limbs in the LAP group as indicated by duplex ultrasound while all limbs in the HLS group still had the same level of femoral incompetence. The authors suggested that LAP is an effective alternative to external valvuloplasty in selected patients with moderate deep venous insufficiency, functional cusps, or insufficiency mainly due to relative enlargement of the femoral vein.

Another study compared HLS to HLS plus external transcommissural valvuloplasty (study group) in limbs with reflux in both the GSV and femoral veins.⁶⁰ During a follow-up of seven to eight years for an available 125 patients, corrected valves remained competent in 71% (45/63). Reflux had reappeared in 19% (12/63) at two to four years after operation in the study group; whereas 53% (33/62) had increased reflux and 47% remained the same in the control group. Clinical deterioration was associated with increased reflux over time rather than with reappearance of reflux after valvuloplasty. Deep axial or segmental venous reflux was not well documented in the above mentioned studies.

In retrospective studies, AVP was reported to decrease by 15–81% after reconstructive surgery or during follow-up of 5–10 years, and 52–77% of repaired valves remained competent.^{61–64} Of these studies, only Rosales *et al.*⁶⁴ included patients with primary CVI only and others had results mixed with a small number of patients with the postthrombotic syndrome (PTS). In Rosales' study,⁶⁴ external transcommissural valvuloplasty was performed on 17 patients (C_4 : $n = 6$, C_5 : $n = 4$, C_6 : $n = 7$) with deep reflux and high level of AVP. AVP reduction was greatest in C_6 patients after operation with a median of 35 mmHg (0 – 65 mmHg), and was maintained through the median follow-up of five years or until the valve became incompetent. However, the results did not reach statistical significance because of the small sample size.

In Masuda's study,⁶¹ as five of 18 normal AVP values were also found in patients with poor clinical results, they stated that AVP could not be reliable to predict the clinical state. VRT was reported to increase by 50% after operation in this study.

Raju *et al.*⁶³ reported a 100% normalized VRT and significantly decreased VFI after operation (3.1 ± 2.4 ml/s vs. 4.1 ± 2.8 ml/s), and the cumulative competency rates of 140 repaired sites were 84% at 12 months, 72% at 24 months, and 59% at 30 months.

In an Australian study of 36 limbs with primary CVI, 125 valves in femoral and popliteal veins were repaired using Venocuff II stents.⁶⁵ The 90% recovery time measured by infrared photoplethysmography (PPG) increased from 6.7 s preoperatively to 12.4 s at 36 months which persisted in the long term, but AVP reduction was only significant at 12 months. The ulcer healing rate was 80% at 36 months, and the number of stents implanted

was statistically associated with an increased number of ulcers healing in multivariable analysis.

McDaniel *et al.*⁶⁶ suggested that venous reconstruction might be considered in patients with DVI and VFI greater than 4 ml/s as they have a 43% chance of recurrent ulceration at one year and of 60% at two years, but if patients have a VFI less than 4 ml/s, deep venous reflux is probably less severe and these patients may not benefit from venous reconstruction.

Respecting Reflux in Compensating Collateral Veins

In order to avoid serious consequences in the venous circulation, care should be taken to detect compensating flow in collateral veins that bypass an obstruction, as happens after or associated with temporary or persistent compression. Reflux is generally systolic during calf muscle contraction or systo-diastolic lasting also into calf muscle relaxation if a superficial incompetence is associated with deep venous obstruction. Any surgical intervention on this situation must be preceded by thorough hemodynamic evaluation. Typical examples are GSV systolic reflux with iliofemoral thrombosis (equivalent to a spontaneous Palma-Dale anastomosis), SSV systolic reflux with femoral occlusion or compression, and reflux in the marginal vein truncular malformation in the Klippel-Trenaunay-Servelle Syndrome (KTS)

Hemodynamic Measurements as Surrogate Endpoints for Treatment Efficacy

Ambulatory venous pressure

AVP measurement is traditionally considered to be the gold standard for global evaluation of venous function of the lower extremity. The AVP reduction fraction represents calf muscle pump function and is independent of the existence or site of valve incompetence. Decrease in AVP by at least 15% or 10 mmHg post-procedure compared with a preoperative baseline value suggests that treatment has been effective.

Venous reflux

Guidelines 2.3.0 of the Society for Vascular Surgery and American Venous Forum⁶⁷ regarding duplex ultrasound scanning for chronic venous disease and valvular incompetence defines the cut-off value for venous reflux

as 0.5 seconds. Post-procedural normalized venous reflux time, resolution of reflux and no newly developed venous incompetence suggest that treatment has been effective. However, a definition of reflux using flow direction and its duration in seconds is not able to “catch” the pathophysiological condition in all cases. Indeed after CHIVA, reflux in the GSV is directed downwards in the same way as the pathological flow and draining flow in saphenous arch tributaries has the same downward direction as pathological pelvic reflux. In these cases, the difference is in the pressure gradient and whether or not reflux has a positive Valsalva maneuver.^{68, 69} An important suggestion comes from the Reflux Elimination Test (RET) which is reaction to compression of the incompetent tributary.^{7, 70}

A competitive reflux is a situation where superficial and deep reflux mask each other. As a practical suggestion, a very wide apparently non refluxing popliteal vein can be rendered incompetent and refluxing if the superficial veins are blocked with a rubber tourniquet.^{7, 71}

The venous filling index (VFI) of APG has been validated as a global index of reflux

using simultaneous measurements with duplex ultrasound, taken from a position of elevation to

dependency.⁷² Studies have shown that it provides a graduated and quantitative improvement with treatments directed against reflux.²⁷ Furthermore, patients whose VFI does not respond fully to treatment against reflux have worse clinical symptoms.⁷³

Calf muscle pump function

Among the available plethysmographic methods which include SPG, DPPG and APG, calf muscle pump function seems to be best quantified with APG. Compared with preoperative measurements, post-procedural reduction in VV by 25%, in VFI by at least 50%, in RVF by 15–30% or an increase in VFT by at least 50% suggests hemodynamic effective treatment. Patients with a VFI greater than 4 ml/s tend to develop recurrent ulcers so that venous reconstruction may be required. In contrast, patients with a VFI less than 4 ml/s are not likely to develop ulcers.

References

1. Bootun R, Lane TR, Davies AH. The advent of non-thermal, non-tumescent techniques for treatment of varicose veins. *Phlebology* 2015;0268355515593186.

2. Elias S, Raines JK. Mechanochemical tumescentless endovenous ablation: final results of the initial clinical trial. *Phlebology* 2012;27(2):67-72.
3. Morrison N, Gibson K, McEnroe S, Goldman M, King T, Weiss R, *et al*. Randomized trial comparing cyanoacrylate embolization and radiofrequency ablation for incompetent great saphenous veins (Ve-Close). *J Vasc Surg* 2015;61(4):985-94.
4. Regan JD, Gibson KD, Rush JE, Shortell CK, Hirsch SA, Wright DD. Clinical significance of cerebrovascular gas emboli during polidocanol endovenous ultra-low nitrogen microfoam ablation and correlation with magnetic resonance imaging in patients with right-to-left shunt. *J Vasc Surg* 2011;53(1):131-7.
5. Todd K, Wright D. Durability of treatment effect with polidocanol endovenous microfoam on varicose vein symptoms and appearance (VANISH-2) *J Vasc Surg: Venous and Lym Dis* 2015;3:258-64.
6. Muller R. Treatment of varicose veins by ambulatory phlebectomy. *Phlebologie* 1966;19(4):277-9.
7. Franceschi C, Zamboni P. Principles of Venous Hemodynamics. New York: Nova Science, 2009.
8. Franceschi C. Théorie et pratique de la cure Conservatrice et hémodynamique de l'insuffisance veineuse en ambulatoire. *Precy-sous-Thil France: de l'Armançon*, 1988.
9. Pittaluga P, Chastanet S, Rea B, Barbe R. Midterm results of the surgical treatment of varices by phlebectomy with conservation of a refluxing saphenous vein. *J Vasc Surg* 2009;50(1):107-18.
10. Rass K, Frings N, Glowacki P, Hamsch C, Graber S, Vogt T, *et al*. Comparable effectiveness of endovenous laser ablation and high ligation with stripping of the great saphenous vein: two-year results of a randomized clinical trial (RELACS study). *Arch Dermatol* 2012;148(1):49-58.
11. Rass K, Frings N, Glowacki P, Graber S, Tilgen W, Vogt T. Same Site Recurrence is More Frequent After Endovenous Laser Ablation Compared with High Ligation and Stripping of the Great Saphenous Vein: 5 year Results of a Randomized Clinical Trial (RELACS Study). *Eur J Vasc Endovasc Surg* 2015;50(5):648-56.
12. Blomgren L, Johansson G, Dahlberg-Akerman A, Thermaenius P, Bergqvist D. Changes in superficial and perforating vein reflux after varicose vein surgery. *J Vasc Surg* 2005;42(2):315-20.
13. van Neer P, Kessels FG, Estourgie RJ, de Haan EF, Neumann MA, Veraart JC. Persistent reflux below the knee after stripping of the great saphenous vein. *J Vasc Surg* 2009;50(4):831-4.
14. Theivacumar NS, Dellagrammaticas D, Mavor AI, Gough MJ. Endovenous laser ablation: does standard above-knee great saphenous vein ablation provide optimum results in patients with both above- and below-knee reflux? A randomized controlled trial. *J Vasc Surg* 2008;48(1):173-8.
15. Carradice D, Mekako AI, Mazari FA, Samuel N, Hatfield J, Chetter IC. Clinical and technical outcomes from a randomized clinical trial of endovenous laser ablation compared with conventional surgery for great saphenous varicose veins. *Br J Surg* 2011;98(8):1117-23.
16. Danielsson G, Jungbeck C, Peterson K, Norgren L. Venous function after restoring valve competence of the great saphenous vein. *J Endovasc Ther* 2003;10(2):350-5.
17. Park UJ, Yun WS, Lee KB, Rho YN, Kim YW, Joh JH, *et al*. Analysis of the postoperative hemodynamic changes in varicose vein surgery using air plethysmography. *J Vasc Surg* 2010;51(3):634-8.
18. Gohel MS, Epstein DM, Davies AH. Cost-effectiveness of traditional and endovenous treatments for varicose veins. *Br J Surg* 2010;97(12):1815-23.
19. Hamel-Desnos C, Ouvry P, Benigni JP, Boitelle G, Schadeck M, Desnos P, *et al*. Comparison of 1% and 3% polidocanol foam in ultrasound guided sclerotherapy of the great saphenous vein: a randomised, double-blind trial with 2 year-follow-up. "The 3/1 Study". *Eur J Vasc Endovasc Surg* 2007;34(6):723-9; discussion 730.
20. Cavezzi A, Frullini A, Ricci S, Tessari L. Treatment of varicose veins by foam sclerotherapy: Two clinical series. *Phlebology* 2002;17:13-18.
21. Wright D, Gobin JP, Bradbury AW. Varisolve European Phase III Investigators Group. Varisolve® polidocanol microfoam compared with surgery or sclerotherapy in the management of varicose veins in the presence of trunk vein incompetence: European randomized controlled trial. *Phlebology* 2006;21:180-190.
22. Rabe E, Otto J, Schliephake D, Pannier F. Efficacy and safety of great saphenous vein sclerotherapy using standardised polidocanol foam (ESAF): a randomised controlled multicentre clinical trial. *Eur J Vasc Endovasc Surg* 2008;35(2):238-45.
23. Ouvry P, Allaert FA, Desnos P, Hamel-Desnos C. Efficacy of polidocanol foam *versus* liquid in sclerotherapy of the great saphenous vein: a multicentre randomised controlled trial with a 2-year follow-up. *Eur J Vasc Endovasc Surg* 2008;36(3):366-70.
24. Hamel-Desnos CM, Guias BJ, Desnos PR, Mesgard A. Foam sclerotherapy of the saphenous veins: randomised controlled trial with or without compression. *Eur J Vasc Endovasc Surg* 2010;39(4):500-7.
25. Rasmussen LH, Lawaetz M, Bjoern L, Vennits B, Blemings A, Eklof B. Randomized clinical trial comparing endovenous laser ablation, radiofrequency ablation, foam sclerotherapy and surgical stripping for great saphenous varicose veins. *Br J Surg* 2011;98(8):1079-87.
26. Shadid N, Ceulen R, Nelemans P, Dirksen C, Veraart J, Schurink GW, *et al*. Randomized clinical trial of ultrasound-guided foam sclerotherapy *versus* surgery for the incompetent great saphenous vein. *Br J Surg* 2012;99(8):1062-70.
27. Kalodiki E, Lattimer CR, Azzam M, Shawish E, Bountouroglou D, Geroulakos G. Long-term results of a randomized controlled trial on ultrasound-guided foam sclerotherapy combined with saphenofemoral ligation vs standard surgery for varicose veins. *J Vasc Surg* 2012;55(2):451-7.
28. Lattimer CR, Kalodiki E, Azzam M, Makris GC, Somiyajulu S, Geroulakos G. Interim results on abolishing reflux alongside a randomized clinical trial on laser ablation with phlebectomies *versus* foam sclerotherapy. *Int Angiol* 2013;32(4):394-403.
29. Belcaro G, Cesarone MR, Di Renzo A, Brandolini R, Coen L, Acerbi G, *et al*. Foam-sclerotherapy, surgery, sclerotherapy, and combined treatment for varicose veins: a 10-year, prospective, randomized, controlled, trial (VEDICO trial). *Angiology* 2003;54(3):307-15.
30. Darvall KA, Sam RC, Bate GR, Adam DJ, Silverman SH, Bradbury AW. Photoplethysmographic venous refilling times following ultrasound guided foam sclerotherapy for symptomatic superficial venous reflux: relationship with clinical outcomes. *Eur J Vasc Endovasc Surg* 2010;40(2):267-72.
31. Bergan JJ, Pascarella L. Severe chronic venous insufficiency: primary treatment with sclerofoam. *Semin Vasc Surg* 2005;18(1):49-56.
32. Coleridge Smith P. Saphenous ablation: sclerosant or sclerofoam? *Semin Vasc Surg* 2005;18(1):19-24.
33. Breu FX, Guggenbichler S, Wollmann JC. 2nd European Consensus Meeting on Foam Sclerotherapy 2006, Tegernsee, Germany. *Vasa* 2008;37 Suppl 71:1-29.
34. Morrison N, Neuhardt DL, Rogers CR, McEown J, Morrison T, Johnson E, *et al*. Comparisons of side effects using air and carbon dioxide foam for endovenous chemical ablation. *J Vasc Surg* 2008;47(4):830-6.
35. Myers KA, Roberts S. Evaluation of published reports of foam sclerotherapy: what do we know conclusively? *Phlebology* 2009;24(6):275-80.
36. Stuart WP, Adam DJ, Allan PL, Ruckley CV, Bradbury AW. Saphenous surgery does not correct perforator incompetence in the presence of deep venous reflux. *J Vasc Surg* 1998;28(5):834-8.
37. Mendes RR, Marston WA, Farber MA, Keagy BA. Treatment of superficial and perforator venous incompetence without deep venous insufficiency: is routine perforator ligation necessary? *J Vasc Surg* 2003;38(5):891-5.
38. Gohel MS, Barwell JR, Wakely C, Minor J, Harvey K, Earnshaw JJ, *et al*. The influence of superficial venous surgery and compression on incompetent calf perforators in chronic venous leg ulceration. *Eur J Vasc Endovasc Surg* 2005;29(1):78-82.
39. Kianifard B, Holdstock J, Allen C, Smith C, Price B, Whiteley MS. Randomized clinical trial of the effect of adding subfascial endoscopic perforator surgery to standard great saphenous vein stripping. *Br J Surg* 2007;94(9):1075-80.

40. Nelzen O, Fransson I. Early results from a randomized trial of saphenous surgery with or without subfascial endoscopic perforator surgery in patients with a venous ulcer. *Br J Surg* 2011;98(4):495-500.
41. Nelzen O, Fransson I. True long-term healing and recurrence of venous leg ulcers following SEPS combined with superficial venous surgery: a prospective study. *Eur J Vasc Endovasc Surg* 2007;34(5):605-12.
42. Walsh JC, Bergan JJ, Beeman S, Comer TP. Femoral venous reflux abolished by greater saphenous vein stripping. *Ann Vasc Surg* 1994;8(6):566-70.
43. Sales CM, Bilof ML, Petrillo KA, Luka NL. Correction of lower extremity deep venous incompetence by ablation of superficial venous reflux. *Ann Vasc Surg* 1996;10(2):186-9.
44. Ting AC, Cheng SW, Wu LL, Cheung GC. Changes in venous hemodynamics after superficial vein surgery for mixed superficial and deep venous insufficiency. *World J Surg* 2001;25(2):122-5.
45. Adam DJ, Bello M, Hartshorne T, London NJ. Role of superficial venous surgery in patients with combined superficial and segmental deep venous reflux. *Eur J Vasc Endovasc Surg* 2003;25(5):469-72.
46. Gohel MS, Barwell JR, Earnshaw JJ, Heather BP, Mitchell DC, Whyman MR, *et al*. Randomized clinical trial of compression plus surgery *versus* compression alone in chronic venous ulceration (ES-CHAR study)—haemodynamic and anatomical changes. *Br J Surg* 2005;92(3):291-7.
47. Dix FP, Picton A, McCollum CN. Effect of superficial venous surgery on venous function in chronic venous insufficiency. *Ann Vasc Surg* 2005;19(5):678-85.
48. Ting AC, Cheng SW, Ho P, Poon JT, Wu LL, Cheung GC. Reduction in deep vein reflux after concomitant subfascial endoscopic perforating vein surgery and superficial vein ablation in advanced primary chronic venous insufficiency. *J Vasc Surg* 2006;43(3):546-50.
49. Padberg FT, Jr., Pappas PJ, Araki CT, Back TL, Hobson RW, 2nd. Hemodynamic and clinical improvement after superficial vein ablation in primary combined venous insufficiency with ulceration. *J Vasc Surg* 1996;24(5):711-8.
50. Puggioni A, Lurie F, Kistner RL, Eklof B. How often is deep venous reflux eliminated after saphenous vein ablation? *J Vasc Surg* 2003;38(3):517-21.
51. Marston WA, Brabham VW, Mendes R, Berndt D, Weiner M, Keagy B. The importance of deep venous reflux velocity as a determinant of outcome in patients with combined superficial and deep venous reflux treated with endovenous saphenous ablation. *J Vasc Surg* 2008;48(2):400-5; discussion 405-6.
52. Pierik EG, van Urk H, Hop WC, Wittens CH. Endoscopic *versus* open subfascial division of incompetent perforating veins in the treatment of venous leg ulceration: a randomized trial. *J Vasc Surg* 1997;26(6):1049-54.
53. Pierik EG, van Urk H, Wittens CH. Efficacy of subfascial endoscopy in eradicating perforating veins of the lower leg and its relation with venous ulcer healing. *J Vasc Surg* 1997;26(2):255-9.
54. Rhodes JM, Gloviczki P, Canton L, Heaser TV, Rooke TW. Endoscopic perforator vein division with ablation of superficial reflux improves venous hemodynamics. *J Vasc Surg* 1998;28(5):839-47.
55. Gloviczki P, Bergan JJ, Rhodes JM, Canton LG, Harmsen S, Ilstrup DM. Mid-term results of endoscopic perforator vein interruption for chronic venous insufficiency: lessons learned from the North American subfascial endoscopic perforator surgery registry. The North American Study Group. *J Vasc Surg* 1999;29(3):489-502.
56. Tawes RL, Barron ML, Coello AA, Joyce DH, Kolvenbach R. Optimal therapy for advanced chronic venous insufficiency. *J Vasc Surg* 2003;37(3):545-51.
57. Rhodes JM, Gloviczki P, Canton LG, Rooke T, Lewis BD, Lindsey JR. Factors affecting clinical outcome following endoscopic perforator vein ablation. *Am J Surg* 1998;176(2):162-7.
58. Maleti O, Perrin M. Reconstructive surgery for deep vein reflux in the lower limbs: techniques, results and indications. *Eur J Vasc Endovasc Surg* 2011;41(6):837-48.
59. Belcaro G, Nicolaidis AN, Ricci A, Laurora G, Errichi BM, Christopoulos D, *et al*. External femoral vein valvuloplasty with limited anterior plication (LAP): a 10-year randomized, follow-up study. *Angiology* 1999;50(7):531-6.
60. Makarova NP, Lurie F, Hmelniker SM. Does surgical correction of the superficial femoral vein valve change the course of varicose disease? *J Vasc Surg* 2001;33(2):361-8.
61. Masuda EM, Kistner RL. Long-term results of venous valve reconstruction: a four- to twenty-one-year follow-up. *J Vasc Surg* 1994;19(3):391-403.
62. Perrin M. Reconstructive surgery for deep venous reflux: a report on 144 cases. *Cardiovasc Surg* 2000;8(4):246-55.
63. Raju S, Berry MA, Neglen P. Transcommissural valvuloplasty: technique and results. *J Vasc Surg* 2000;32(5):969-76.
64. Rosales A, Slagsvold CE, Kroese AJ, Strandén E, Risum O, Jorgensen JJ. External venous valve plasty (EVVP) in patients with primary chronic venous insufficiency (PCVI). *Eur J Vasc Endovasc Surg* 2006;32(5):570-6.
65. Lane RJ, Cuzzilla ML, McMahon CG. Intermediate to long-term results of repairing incompetent multiple deep venous valves using external valvular stenting. *ANZ J Surg* 2003;73(5):267-74.
66. McDaniel HB, Marston WA, Farber MA, Mendes RR, Owens LV, Young ML, *et al*. Recurrence of chronic venous ulcers on the basis of clinical, etiologic, anatomic, and pathophysiologic criteria and air plethysmography. *J Vasc Surg* 2002;35(4):723-8.
67. Gloviczki P, Comerota AJ, Dalsing MC, Eklof BG, Gillespie DL, Gloviczki ML, *et al*. The care of patients with varicose veins and associated chronic venous diseases: clinical practice guidelines of the Society for Vascular Surgery and the American Venous Forum. *J Vasc Surg* 2011;53((5 Suppl)):2S-48S.
68. Franceschi C. Measures and interpretation of venous flow in stress tests. Manual compression and Parana manoeuvre. Dynamic reflux index and Psatakis index *J des Maladies Vasculaires* 1997;22(2):91-5.
69. Cappelli M, Molino Lova R, Ermini S, Zamboni P. Hemodynamics of the sapheno-femoral junction. Patterns of reflux and their clinical implications. *Int Angiol* 2004;23(1):25-8.
70. Zamboni P, Cisno C, Marchetti F, Quaglio D, Mazza P, Liboni A. Reflux elimination without any ablation or disconnection of the saphenous vein. A haemodynamic model for venous surgery. *Eur J Vasc Endovasc Surg* 2001;21(4):361-9.
71. Delfrate R. *Manuale di Emodinamica venosa degli arti inferiori. (A Primer of Venous Hemodynamics of Lower Limbs)*. Cremona, Italy: Fantigrafica, 2010.
72. Lattimer CR, Azzam M, Kalodiki E, Geroulakos G. Venous filling time using air-plethysmography correlates highly with great saphenous vein reflux time using duplex. *Phlebology* 2014;29(2):90-7.
73. Owens LV, Farber MA, Young ML, Carlin RE, Criado-Pallares E, Passman MA, *et al*. The value of air plethysmography in predicting clinical outcome after surgical treatment of chronic venous insufficiency. *J Vasc Surg* 2000;32(5):961-8.

Chapter 8 Hemodynamic changes after CHIVA, ASVAL and Hook Phlebectomy

PART 1. CHIVA

The principles of CHIVA

CHIVA is an acronym for “Cure Conservatrice et Hemodynamique de l’Insuffisance Veineuse en Ambulatoire” (hemodynamic correction of venous insufficiency in outpatients).¹⁻⁵ The rationale of this strategy is based on restoring drainage of flow from the most superficial

to deepest venous networks of the lower limb with sparing of the main saphenous trunks.⁵

According to a 2006 UIP consensus on lower limb venous anatomy, three different compartments are recognized based on their relationship to the muscular fascia.^{6,7} **Venous network N3** is superficial to the fascia and is represented by saphenous tributaries surrounded by subcutaneous fat.⁷ **Venous network N2** consists of the great saphenous vein (GSV), small saphenous vein (SSV), anterior accessory saphenous vein (AASV) and Giacomini vein which lay inside a fascial layer that splits in two, wrapping the N2 veins like a natural elastic stocking.⁸ **Venous network N1** includes the deep veins (common femoral, femoral, popliteal, soleal, gastrocnemial, and tibial) located deep to the deep fascia and surrounded by muscles.⁹

Normal blood flow is from the most distal lower extremity toward the heart and from the most superficial (N3) toward the deeper compartments (N2 and then N1).¹⁰ All three networks are connected by perforating veins, physiologically draining from N3 to N2 then to N1.²⁻⁸ The CHIVA theory considers that flow is pathological whenever there is subversion of the hierarchical order of venous network emptying.³ In this pathological scenario, an **Escape Point** is defined as an anatomical location where venous reflux occurs that drains blood from a deeper to a more superficial compartment. For example, in the case of an incompetent sapheno-femoral terminal valve, the Escape Point is the sapheno-femoral junction (SFJ) since venous drainage flows from the deeper N1 compartment (the common femoral vein) towards the most superficial N2 network (the GSV).

Flow occurs only in the presence of a pressure gradient.¹¹ A fundamental CHIVA principle is that pathological reflux through a vein from the deep to superficial compartment is always associated with a re-entry perforating vein **or Re-entry Point**,^{2,5} draining back into the deepest compartments. For example, in the previous case of an incompetent SFJ with a refluxing GSV (pathological flow from N1 toward N2), the re-entry points are perforating veins that connect the GSV to the deep (N1) network and drain refluxing blood back towards the deep compartment.

In a different refluxing pattern, a perforating vein can represent an escape point if it drains from a deeper toward a more superficial compartment. A typical

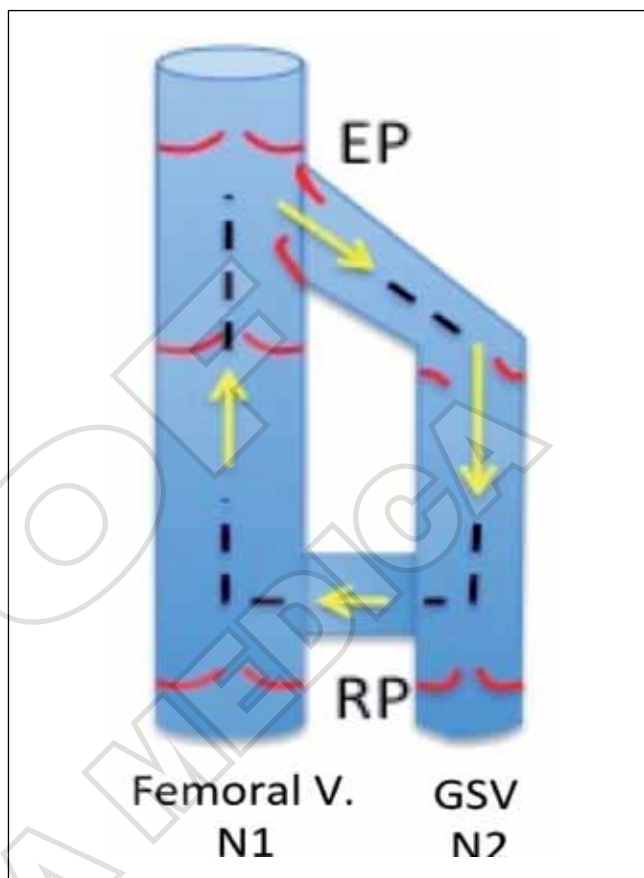

Figure 8.1.—A Closed shunt.

example is an incompetent mid-thigh (Hunterian) perforating vein that allows reflux from the femoral vein towards the GSV. Another perforating vein must be expected along the affected network representing the re-entry point draining blood back into the deeper compartment.

A venous tract that is included between the escape and re-entry points is defined as a **Shunt**.

The entire system of pathology can be considered as a re-circulation circuit. Duplex techniques using two simultaneous probes at different locations are able to confirm its presence.¹² Quantification is possible by measuring the volume displacements within the great saphenous vein using a re-circulation index.¹³ This anomalous venous drainage can produce three different reflux patterns: the so called Closed Shunt, Open Shunt and Bypassing Shunt.^{2,5}

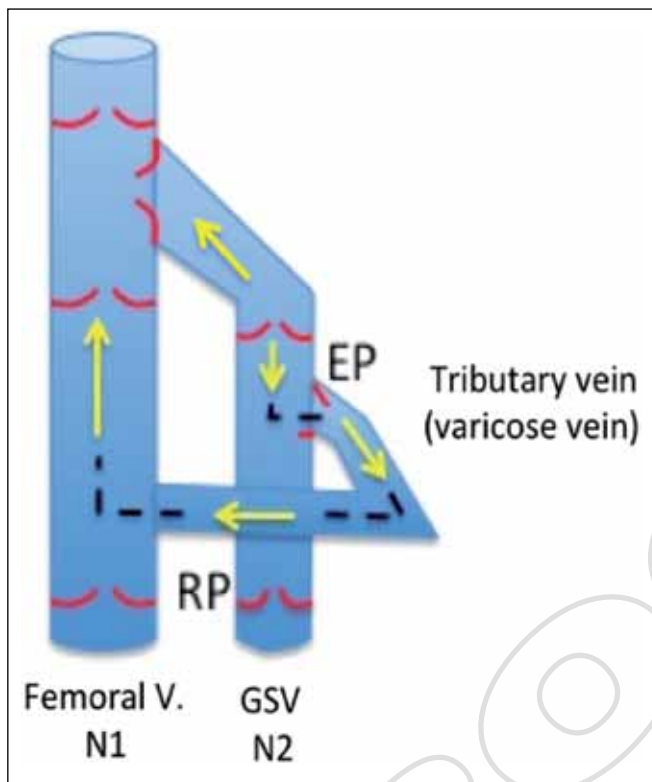

Figure 8.2.—An open shunt.

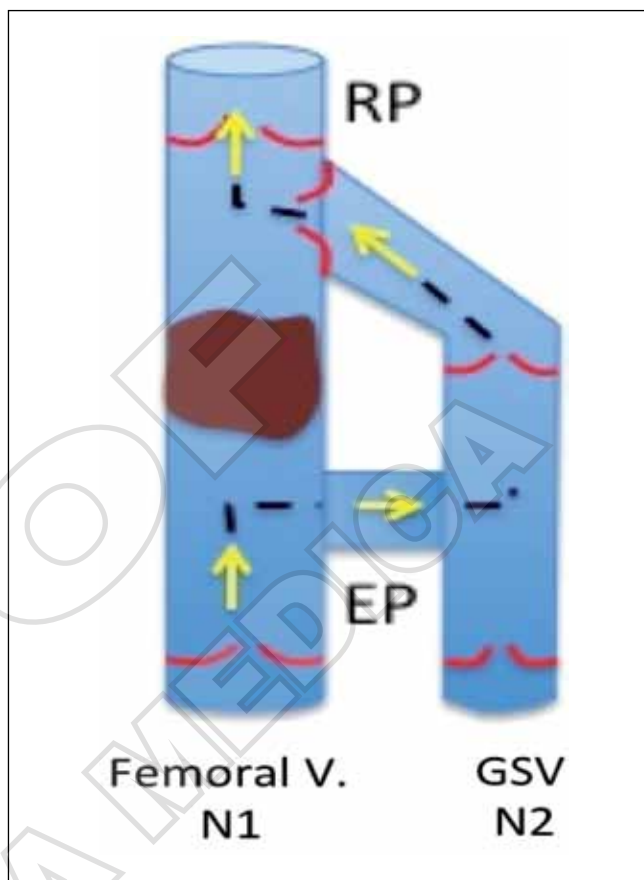

Figure 8.3.—A by-passing shunt.

A **Closed Shunt** derives its name from creation of a “closed” circuit (Figure. 8.1). A typical example is an incompetent SFJ (escape point from N1 to N2) with a refluxing GSV draining towards a re-entry point that is represented by a perforating vein flowing from the GSV back to the deeper N1 compartment during muscle relaxation. Blood that re-enters through this perforating vein is pushed up toward the heart during muscular systole. Nevertheless, a proportion of this blood passing by the incompetent SFJ (escape point) will be pathologically deviated again toward the more superficial N2 (GSV) compartment so establishing a closed circuit further increasing venous pressure into the shunt. According to the CHIVA therapeutic strategy, it is mandatory to break this vicious circle at the escape point in order to decrease pathological venous hypertension inside the shunt. In the example above, a high ligation will effectively treat the escape point and thus suppress the venous pressure overload.

An **Open Shunt** is not associated with recirculation but instead with a deviated drainage pattern that leads to a

venous pressure increase in the vessel that is overlapped by blood coming from a deeper compartment. An example is a competent SFJ with reflux in an incompetent GSV mid-leg tributary passing to a re-entry perforating vein along the same tract to drain directly into the deepest compartment (N1). In this case, the escape point is represented by the compartment jump from the GSV (N2) to the incompetent tributary (N3). Blood that refluxes along the incompetent tributary during muscle relaxation gets back to the deeper compartment N1 by the Re-entry perforating vein. During muscular systole, blood will flow along the N1 compartment without jumping into the N2 compartment (GSV) at a higher level due to competence of the SFJ. In this case, there is no recirculation so that the shunt is defined as being “open”. In this scenario, CHIVA strategy aims to decrease shunt venous pressure and stop pathological compartment jump at the escape point by flush ligation

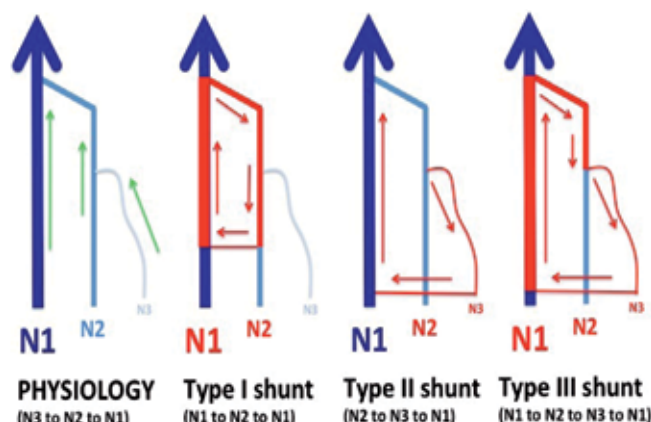

Figure 8.4.—Normal physiological direction of flow and flow direction in Type I-III shunts.

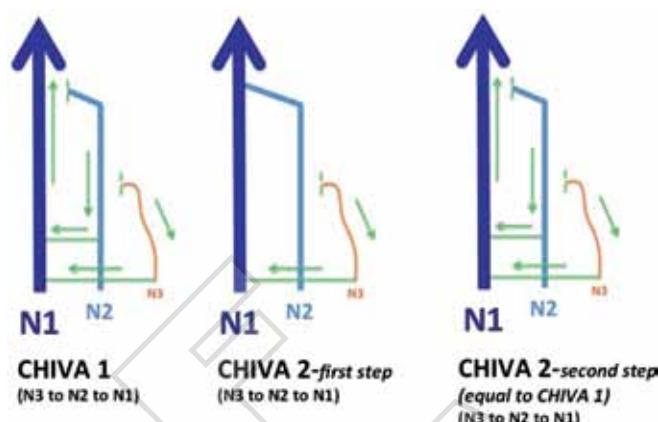

Figure 8.5.—CHIVA 1 and CHIVA 2 (first and second steps).

of the incompetent tributary. This will stop N2-N3 reflux allowing the same tributary to drain through its own re-entry perforating vein directly into the N1 compartment.

A **By-passing Shunt** directs flow around an obstruction. For example, in the presence of a proximal thigh femoral vein occlusion by thrombus, a perforating vein connecting the femoral vein to the GSV can reverse its drainage direction to allow flow from the deeper N1 toward the more superficial N2 network. If GSV valves are competent, this shunted blood drains in a cardiopetal direction bypassing the femoral obstruction finding its re-entry point at the SFJ. It is evident that a by-passing shunt is a natural defence against venous hypertension and in the above scenario, there is no indication for intervention, treatment being with appropriate elastic stocking compression, anticoagulation if appropriate and accurate sonographic follow-up.

Within the closed, open and by-passing patterns, CHIVA identifies different types of refluxing networks according to localization of both the escape and re-entry points. The three most frequent networks are named type I, II and III shunts (Figure 8.4).^{2, 5} The shunt type classification also includes a further three kinds of compartment jumps, but being rarer both their hemodynamic and strategic correction descriptions are left to more specialised textbooks.²

In **type I shunt**, the escape point is from N1 (deep venous system) to N2 (saphenous system) and the re-entry point from N2 (saphenous system) to N1 (femoral system). In **type II shunt**, the reflux pattern is more

superficial with an escape point from N2 (saphenous system) to N3 (tributary system) and the re-entry point from N3 (tributary system) to N1 (femoral system) or to N2 (saphenous system). In **type III shunt**, there are two escape points, one from N1 (deep system) to N2 (saphenous system) and another from N2 (saphenous system) to N3 (tributary system) while the re-entry point is focused on N3 (tributary system).

In relation to therapeutic strategies, a fundamental principle is to preserve a re-entry perforating vein focused along N2. In fact, N1-N2 escape point treatment is possible only when a re-entry perforating vein is situated along N2 for otherwise there is no energetic gradient to move blood inside the N2 network leading to a risk of stasis and thrombosis.^{2, 5, 11} For example, in a type I shunt with an incompetent SFJ, N1 to N2 escape point treatment by high ligation is feasible because of a re-entry perforating vein that is focused along the N2 trunk draining blood back towards N1.

The CHIVA strategy is to perform minimally invasive flush ligations with high ties to restore the physiological order of emptying from the most superficial to deepest venous networks. There are two main procedural options depending on the shunt type, the so called CHIVA 1 or CHIVA 2 procedures (Figure 8.5).²⁻⁴

CHIVA 1 interrupts flow from the N1 to N2 compartments maintaining the re-entry perforating vein along the saphenous trunk while incompetent N3 tributaries can be flush ligated if they are present during the same procedure. The **CHIVA 2 procedure** is the correct strategy if there are no re-entry perforating veins along the

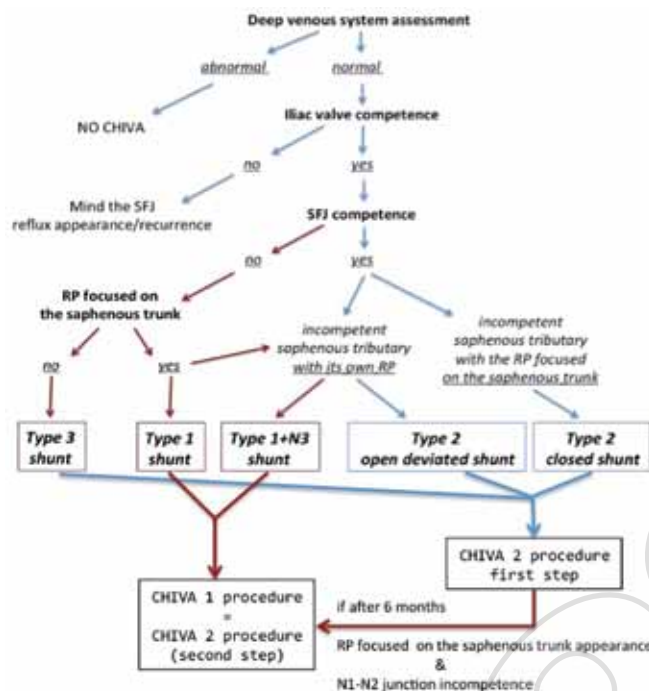

Figure 8.6.—Flow-chart for the most common shunt types and consequent indications for different strategies.

N2 network and this is performed in two surgical steps. In the **CHIVA 2 first step**, a simple flush ligation of incompetent collaterals is performed so as to treat N2-N3 escape points preserving re-entry points draining from N3 to N1 (type II shunt). However, if there is a concomitant N1-N2 escape point (i.e. type III shunt), after this first step then pathological saphenous reflux will persist until a previously inefficient perforating vein situated on N2 enlarges to reach an adequate calibre to effectively drain flow so as to form a closed shunt between N1 and N2 networks, transforming a type 3 shunt to a type 1 shunt. This then allows the **second step of the CHIVA 2 procedure** which simply corresponds to a CHIVA 1 procedure (N1-N2 escape point treatment).

Figure 8.6 provides a flow chart for the most common shunt types and consequent indications for different strategies.

Hemodynamic changes after CHIVA using CHIVA terminology

As indicated above, CHIVA aims to spare the GSV but maintain a flow once reflux points are controlled.

Flow direction in the GSV is downward in the CHIVA 1 procedure from the disconnected GSV junction to a re-entry perforating vein with outlet located on the trunk.^{3, 4, 14} By contrast, flow direction is upward in the CHIVA 2 procedure.¹⁵⁻¹⁸

While reports and controlled studies on clinical results of CHIVA reached a good level of evidence, reports on CHIVA rarely assessed hemodynamic changes induced by the procedure. However, some data are available and constitute extremely interesting models of both venous hemodynamics and pathophysiology.

This section summarizes available hemodynamic results after CHIVA 1 and CHIVA 2 procedures in accordance with validated methods for assessment.

Changes in flow direction

After performing **CHIVA 1** with interruption of the escape point, the GSV remains in situ. The postoperative flow will be as follows. If the escape point were N1 (deep vein) to N2 (GSV) through the SFJ, the CHIVA strategy would be to close the SFJ resulting in downward flow in the GSV from tributaries which would drain through the next perforating vein (see Figure. 8.5 left). If the escape point were N1 (deep vein) to N2 (GSV) via a perforating vein (e.g. at the thigh) and N2 (GSV) to N3 (tributary), the CHIVA strategy would be to close the perforating vein and the origin of the refluxing tributary and flow in the GSV would then be orthograde from foot to groin.

After performing **CHIVA 2** with interruption of one or more tributaries by flush ligation, two possible results may be seen. In the first instance, the GSV would have orthograde flow with no valve incompetence and this is more probable with a small diameter GSV or competent terminal valve prior to surgery. In the second instance, a tributary will drain reflux or a perforating vein will open and either will recirculate flow from the GSV to deep veins. In this case, CHIVA 1 procedure will then be needed (see Figure. 8.5. middle and right).

Measurement of phlebologic parameters were performed three months and three years after CHIVA intervention pooling CHIVA 1 and CHIVA 2 procedures with the following results, all significant when compared to preoperative values:

Reduced common femoral vein diameter after three months and further reduction after three years,

Reduced GSV diameter at the proximal thigh to normal diameter values after three months and further reduction after three years.

Increase of PPG refilling time at each interval.

Ambulatory venous pressure (AVP)

AVP after CHIVA 1 procedure

There is only one study that assessed AVP following CHIVA 1 procedures¹⁹ and no studies following CHIVA 2. In this study, 73 patients underwent AVP measurements before and six months after CHIVA 1 which consisted of SF disconnection plus flush ligation of tributaries at the saphenous trunk sometimes complemented by multiple stab avulsions. The preoperative mean AVP 50.13 ± 6.56 mmHg was reduced to 28.82 ± 7.14 mmHg at six months after the operation ($p < 0.001$). (Figure. 8.7)

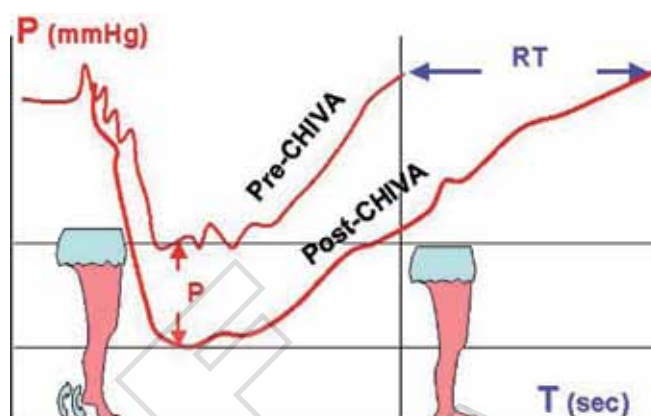

Figure 8.7.—Example of AVP after 10 tiptoe movements before and six months after CHIVA 1 operation.

TABLE 8.1.—Pre and postoperative APG parameters assessed in the surgical group. Grey cells describe postoperative parameters significantly different as compared with preoperative assessment ($p < 0.001$).

APG assessment	TV	VFI	EF	RVF
Preoperative	170 ± 54.6	6.7 ± 3.4	48 ± 12.5	40 ± 15.7
6 m. after surgery	134 ± 44.1 (-25%)	3.0 ± 0.51 (-44%)	57.0 ± 18.1	29 ± 15.1 -31%
3 y. after surgery	141 ± 42.5 (-16%)	5.35 ± 2.03 (-5.92%)	54.0 ± 14.3 (+12%)	22.5 ± 14.7 -35%

Light reflection rheography (LRR) after CHIVA 1 procedure

The same group of 73 patients underwent LRR evaluation before and six months after CHIVA 1.¹⁹ The mean preoperative refilling time increased from 10.12 ± 2.6 seconds to 19.80 ± 4.91 seconds ($p < 0.001$) at six months after operation.

Air plethysmography (APG) after CHIVA 1 procedure

In a RCT, 47 patients with leg venous leg ulcers due to primary varicose veins were randomised to either CHIVA 1 or compression.³ Healing was 100% (31 days) in the CHIVA group and 96% (63 days) in the compression group while recurrence at three years was 9% in the CHIVA group and 38% in the compression group. APG parameters were assessed in the surgical group at the time of randomization and repeated six months and three years later (Table 8.1). All four parameters except ejection fraction, significantly improved at six months after operation. However, after three years, only residual volume fraction (RVF) was found to be consistently corrected and significantly improved. However, this is the most important parameter since it correlates with AVP and represents the net volume of blood that remains in the leg veins after exercise.²⁰ Interestingly, RVF returned to pathological values only if SF reflux recurred.

TABLE 8.2.—Effect if CHIVA 1 and CHIVA 2 (first step) on APG measurements.

APG assessment	VV mL/air	VFI mL/s	EF% of VV	RVF% of VV
Preoperative	170 ± 54.6	6.7 ± 3.4	48 ± 12.5	40 ± 15.7
6 months post-op	134 ± 44.1* (-25%)	3.0 ± 0.51* (-44%)	57.0 ± 18.1	29 ± 15.1* -31%

APG, Air-plethysmography, VV, total venous volume; VFI, venous filling index; EF, ejection fraction; RVF, residual volume fraction. Preoperative and 6 months post-operative APG parameters expressed as mean±SD. In parenthesis are reported the rate of postoperative variations. *Postoperative parameters significantly different compared with preoperative assessment ($P < 0.001$).

In a subsequent study APG was used to evaluate venous function in patients in CEAP clinical class C6 at baseline and six months after surgery. In this study the procedure was CHIVA 1 in about 80% of patients while the remainder had the first step of the CHIVA 2 procedure. The APG parameters are shown in Table 8.2 where a highly significant improvement is apparent.¹⁵

APG after CHIVA 2 procedures

A randomised study was performed that involved 40 limbs in 40 patients with incompetent SFJ, reflux

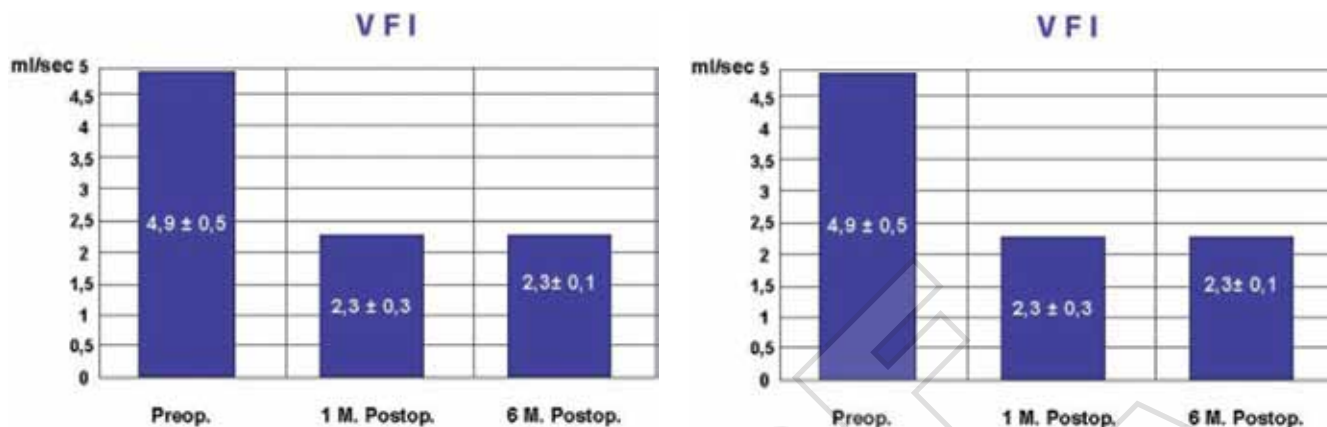

Figure 8.8.—(a) VFI changes after 1st step CHIVA 2 procedure. Figure 8.8 (b) RVF changes after 1st step CHIVA 2 procedure. (From Eur. J. Vasc. Endovasc. Surg. 2001)¹⁵

in the main GSV trunk, one or more re-entry perforating veins on tributary veins and competent deep veins and small saphenous veins.¹⁵ The clinical class of patients ranged from C₂ to C₆ (25 with C₂, 7 with C₃, 4 with C₄, 2 with C₅ and 2 with C₆). The APG was used to assess changes in venous function comparing CHIVA (CHIVA 1 and CHIVA 1 +2) to compression in patients with ulcers. With the exception of ejection fraction (EF) all APG hemodynamic parameters improved significantly at six months. Venous volume (VV) decreased from 150 ml (95% CI 133 to 167) to 119 ml (95% CI 107 to 133), venous filling index (VFI) decreased from 5.0 ml/sec (95% CI 5.0 to 5.9) to 2.0 ml/sec (95% CI 2.0 to 2.7) and residual volume fraction (RVF) changed from 42% (95% CI 36 to 47) to 30% (95% CI 26 to 34) (Figure 8.7). The improvement of VFI (Figure 8.7a) and RVF (Figure 8.7b), demonstrated that reflux in the GSV was completely suppressed by disconnecting the tributary containing the re-entry perforating vein or by just eliminating the gradient between the reflux point (i.e. the SFJ) and the re-entry point.

Reflux in the GSV did recur at six months in 15% of patients and this was due to a newly developed re-entry perforating vein on the main GSV trunk. The Figure shows the minimal non-significant worsening of APG parameters by comparing one and six month results. With time, a higher rate of reflux recurrence is expected with consequent worsening of APG parameters in some patients but this would then be corrected by performing high ligation (CHIVA 1+2 procedure).^{3, 14, 16}

Duplex ultrasound scanning

Duplex ultrasound scanning after CHIVA 1 procedures

One of the most debated points of the CHIVA 1 procedure is the persistence of downward flow with re-entry at the perforating vein after high ligation. Several investigators consider this to constitute reflux.^{21, 22} However, a duplex ultrasound investigation after CHIVA 1 procedures demonstrated significantly different hemodynamic parameters of this reverse flow to preoperative findings.²³ The GSV cross sectional area decreased from 49.0 ± 36.2 to 14.1 ± 10.1 mm² indicating reduced volume load. Peak systolic velocity (PSV) changed in direction pre -20.31 ± 18.21 to post 18.46 ± 6.03 cm/sec which is the expected natural consequence of high tie CHIVA 1. End diastolic velocity (EDV) changed from pre 30.7 ± 32.0 to post 10.6 ± 5.1 . Finally the resistance index (RI) as an impedance parameter derived from the formula $RI = PSV/PSV-EDV$ was significantly different: pre 3.50 ± 2.22 , post 0.44 ± 0.15 ($p=0.0001$). The findings that reverse flow significantly improved venous drainage correlated with improved functional parameters like AVP and APG findings previously described.

Duplex ultrasound scanning after CHIVA 2 procedures

Several studies report recovery of upward flow in the GSV after the first step of the CHIVA 2 procedure.¹⁵⁻¹⁷ A major point for discussion is the durability of such

a hemodynamic change.¹⁷ It has recently been demonstrated that this depends on the preoperative competence of the terminal valve at the SFJ so that a preoperative duplex ultrasound scan may predict the durability of reflux suppression following a CHIVA 2 procedure.¹⁸ At three year follow up of legs with a competent terminal valve, 100% were rated as cured (Hobbs' class A or B) and 14% developed recurrent varices. Patients with an incompetent terminal valve had significantly worse results in that 29% had Hobbs' class A or B and 82% developed recurrence ($P < 0.001$). This finding demonstrates how preoperative duplex ultrasound may provide a reliable indication for minimally invasive sparing of saphenous vein surgery.

PART 2. ASVAL

The principles of ASVAL

The ASVAL method²⁴ (Ablation Sélective des Varices sous Anesthésie Locale) or Ambulatory Selective Varices Ablation under Local anesthesia is based on the concept of the ascending or multifocal evolution of the varicose vein disease. Numerous publications based on precise and detailed duplex ultrasound investigations,²⁵⁻²⁹ biochemical, histological and morphological studies³⁰⁻³² challenge the theory of descending disease progression, highlighting the possibility for local or multifocal early distal evolution of the disease, sometimes ascending or antegrade. The fact that the terminal valve of the SFJ is frequently competent (in > 50% of cases) in the presence of truncal reflux has been clearly documented.^{28, 33-35} Thus, Labropoulos and al. conclude that venous wall remodeling may appear in any venous segment irrespective of the quality of its valves.³⁶

In addition to the ascending pathophysiological concept, the ASVAL method considers that progression of the disease starts in the surprofascial tributaries, which are the most superficial, the most exposed veins outside the saphenous compartment and whose walls are the thinnest. Venous dilatation begins on the surprofascial tributaries distally, where the hydrostatic pressure is higher, creating a dilated and refluxing venous network called "varicose reservoir (VR)" within the surprofascial space.^{27, 37, 38} When this refluxing network becomes large enough, it can create a "filling" effect in the saphenous vein, leading to decompensation of the saphenous vein wall, reaching progressively the SFJ or SPJ. The

saphenous vein is the superficial vein with the thickest and most muscular wall, protected by the saphenous compartment of the subcutaneous fascia in which it is contained. As such, it would be the last vein to experience decompensation as varicose disease progresses. According to this hypothesis, valvular insufficiency is caused by the dilatation of the vein.

The goal of the ASVAL method is to decrease or eliminate the saphenous vein reflux by minimizing VR using ambulatory phlebectomy described by Robert Muller³⁹ or sclerotherapy. Pre-operative ultrasound assessment has enhanced the precision for phlebectomy.^{1, 40-44}

Hemodynamic changes after ASVAL using conventional terminology

Treatment of reflux in GSV or SSV by ASVAL, consists of elimination of all dilated superficial varicose tributaries by phlebectomy or sclerotherapy from their uppermost connection to the saphenous trunk down to their most distal point (Figure 8.8). Following such a procedure reflux in the GSV disappears^{15, 24} and GSV diameter becomes reduced.⁴⁵ Quill and Fegan also found such reversibility of the saphenous reflux following sclerotherapy.⁴⁶

After ablation of the superficial incompetent venous network, saphenous vein will empty upwards through the junction during the systolic phase of walking and if the ablation of the VR includes prevalent connections between saphenous vein and VR, no retrograde saphenous flow will be possible during diastole, even in the presence of incompetent valves in the saphenous trunk. Reflux is no longer elicited through duplex ultrasound with the compression/release or Valsalva manoeuvres.

Prior to varicose tributary avulsion, this venous reflux pattern is typically elicited during ultrasound examination using the "Test of Reversibility (TR)".¹⁵ Finger compression of the uppermost varicose tributary connected to the refluxing saphenous vein can abolish saphenous reflux at the ultrasound examination⁵ (Figure 8.9).⁴ The TR has been reported positive in 56% of limbs with GSV varicose veins with a 96% positive predictive value for the abolition of the GSV reflux, which remained high 94.7% at 1 and 2 years of follow-up.⁴⁷

A prediction model giving a score that correlates with a probability of restoring GSV competence has also been suggested.⁴⁸ This model includes CEAP classification,

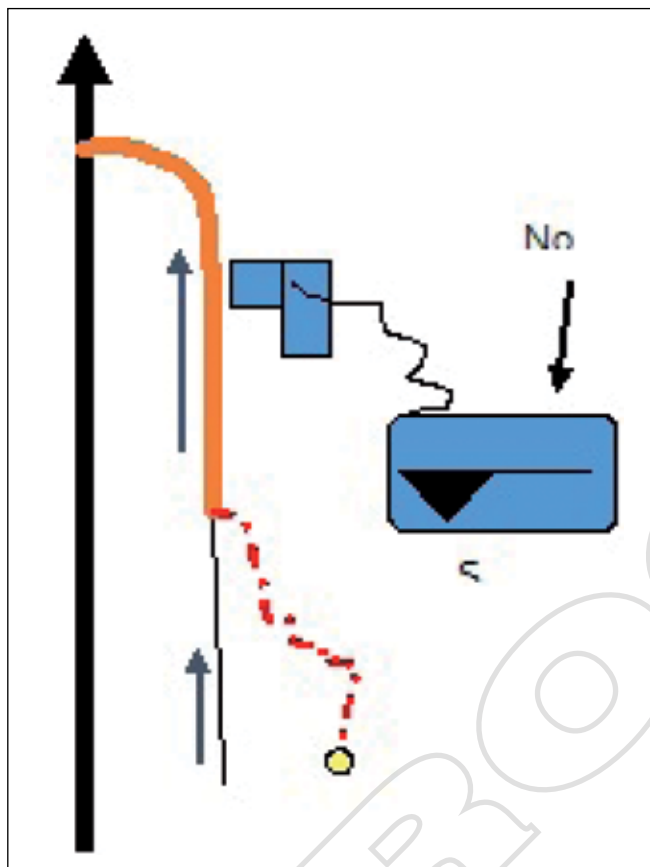

Figure 8.9.—Abolition of reflux after phlebectomy.

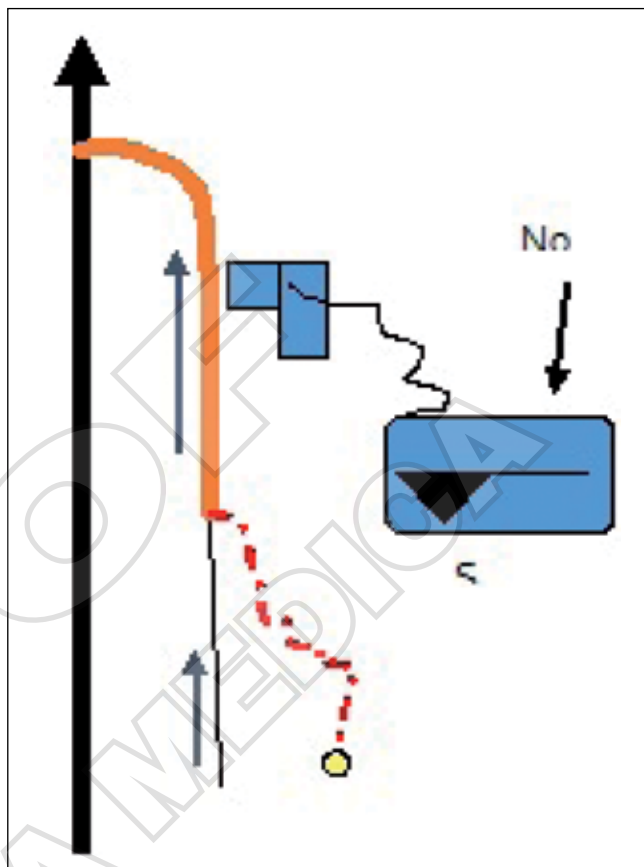

Figure 8.10.—Test of reflux reversibility.

number of refluxing segments, GSV diameter proximal to the tributary, and reflux elimination test result.

The disappearance of saphenous reflux shown by ultrasound after ASVAL could last for months or years^{1, 2, 24, 37} but may recur at late follow-up. This happens when small tributaries dilate creating a new VR. Then saphenous vein will dilate again leading to a reflux which could be characterized by a low volume reflux (Figure 8.10 left) in the early recurrence period, then by a higher volume reflux due to the dilatation of the saphenous vein increases (Figure 8.10 right). In the presence of a prolonged and high volume saphenous reflux, the evolution of a recurrent varicose vein can be quicker.

In Pittaluga's series,³⁷ after 303 phlebectomies in 221 patients, GSV reflux was totally abolished after 6 months. It was abolished in 70%, 69%, 69%, 68%, and 66% of limbs at 1,2,3 and 4 years respectively. Symptoms improved or disappeared in 84%, 84%, 83%,

81%, and 78% of limbs at each annual check-up until the fourth year. There was freedom from recurrence of varices in 96%, 95%, 92%, and 89% respectively at these intervals while GSV diameter at the saphenous confluence significantly decreased in 243 limbs after six months (5.87 +/- 0.23 mm vs. 7.87 +/- 0.25 mm preoperatively; $P = 0.0001$).

In another prospective study by Biemans and al.⁴⁸ involving 94 patients with large varicose tributaries and GSV reflux assessed by duplex, single phlebectomies led to abolition of the GSV reflux in 50% of the cases, with a significant reduction of the GSV diameter and a significant improvement of the AVVQ score in all cases. Even in cases in which GSV reflux was not abolished after single phlebectomy, the reduction of the peak velocity combined with the decrease of the GSV diameter led to a reduction of the volume of the reflux.²⁴ The conclusion was that beyond the threshold of 0.5 s defining a patho-

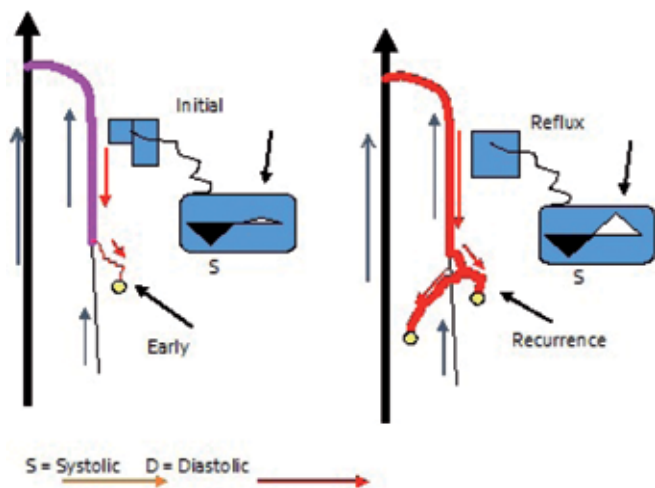

Figure 8.11.—Low volume reflux (left) during early recurrence and high volume reflux (right) at a later stage when the varicose reservoir is increased.

logical reflux, the volume of the reflux could explain the clinical consequences. The effect of single phlebectomy on the volume of GSV reflux might explain the absence of clinical consequences in the majority of the persistent or recurrent GSV refluxes after ASVAL.^{37, 48, 49}

Some studies have highlighted that many limbs with GSV reflux have SFJ incompetence associated with re-entry perforating veins along one or more incompetent tributaries.^{2, 4} Other studies have indicated that a competent SFJ terminal valve is very common and is seen in up to 59% of limbs with GSV incompetence.⁶ In these patients, GSV reverse flow may be associated with pelvic vein reflux, an incompetent pre-terminal valve of the SFJ or of other saphenous valves with tributary drainage within the GSV trunk or perforating veins (Figure 8.11). In such cases treatment focused on the pelvic veins and the VR may abolish saphenous reflux.

Similarly, re-entry perforating veins may be connected to the saphenous trunk, with or without further re-entry perforating veins along incompetent tributaries.² In this situation, the reversibility test is negative because excluding refluxing tributaries alone does not abolish GSV reflux entirely. Although reduced, reflux persists because trunk retrograde flow directly empties into deep veins through perforating veins.² In this situation, treatment focused on the VR will improve saphenous reflux and usually no other additional surgical procedure is necessary.

In Cappelli's series, 55% of limbs with GSV reflux

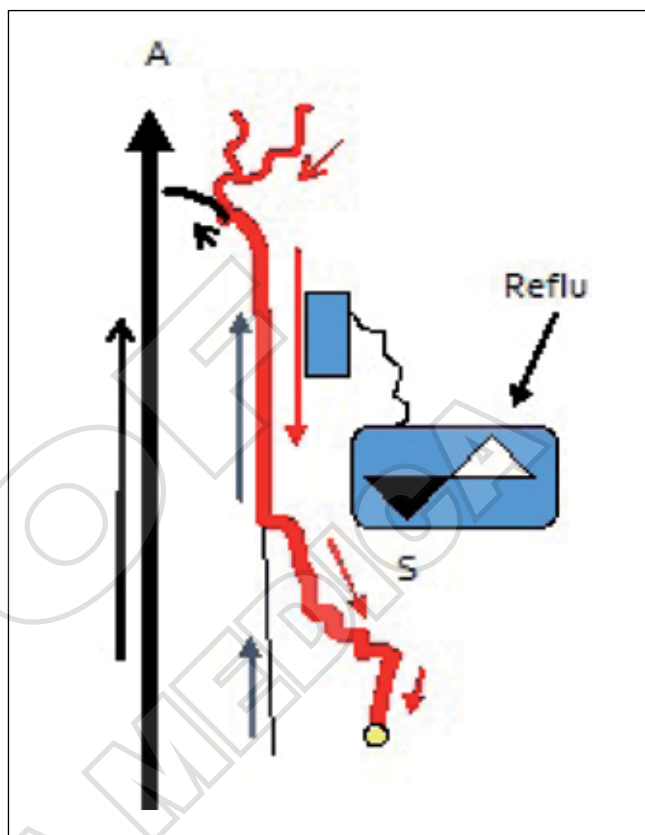

Figure 8.12.—Reflux in GSV in the presence of a competent terminal valve.

had an incompetent terminal valve while the latter was competent in the remaining 45%.^{50, 51} Thus, terminal valve incompetence is not necessary for the development of superficial vein reflux.

The importance of the terminal valve is controversial. Zamboni demonstrated a clear difference in mid-term follow-up outcomes according to terminal valve competence or incompetence.¹⁸ After the first step of CHIVA 2, the incidence of recurrence of reflux determined by ultrasound was significantly higher in patients with terminal valve incompetence (82% vs. 14%). Furthermore, terminal valve competence is associated with a mid-thigh GSV diameter which is usually less than 6 mm,^{50, 51} and this is likely to influence the amount of reflux and results after single phlebectomy. Conversely other studies reported that the status of the terminal valve had no influence on the evolution of the saphenous reflux after ASVAL^{24, 37} and was not the main criterion to decide to spare the GSV.⁵²

PART 3. HOOK PHLEBECTOMY

Hemodynamic changes after hook phlebectomy as interpreted by the “CHIVA” school and using CHIVA terminology

As indicated in Part 2, hook phlebectomy is avulsion of supra-fascial varicose veins as popularized by Robert Muller in the 1960s³⁹ using hooks under local anesthesia. Pre-operative ultrasound assessment has enhanced precision for hook phlebectomy (HP).^{1, 40-44, 53-60}

Elimination of dilated superficial varicose tributaries by phlebectomy usually involves varices from their uppermost connection to the saphenous stem down to re-entry points. When the whole VR is removed, hook phlebectomy may be considered an analogue to ASVAL method²⁴ (see definition of ASVAL in Part 2) or the first step of CHIVA 2.¹ They all interrupt part of the shunt pathway. As a consequence, the hemodynamic changes that may occur depend on the pre-phlebectomy type of saphenous shunt.

If the saphenous shunt includes one or more prominent re-entry points located only within the varicose network and not within the saphenous stem, then abolition of saphenous reflux is to be expected after hook phlebectomy (Figure 8.8). However, if a re-entry perforating vein is connected to the saphenous stem then some saphenous reflux may persist and diameter reduction is expected to be less.

After hook phlebectomy, the saphenous vein will empty upwards through the junction and proximal perforating veins during the systolic phase of walking and if the excised varicosities were associated with the prevalent re-entry points then no retrograde saphenous flow will be possible during diastole, even in the presence of incompetent valves in the saphenous stem. Reflux is no longer elicited through duplex ultrasound with the compression/release or Valsalva manoeuvres.

This specific venous shunt pattern is typically elicited during ultrasound examination which can involve the RET prior to varicose tributary avulsion.¹⁵ Finger compression of the uppermost varicose tributary connected to the refluxing saphenous vein can abolish saphenous reflux at the ultrasound examination if a re-entry point is not from the saphenous stem and may exhibit a positive RET (Figure 8.9).⁴ A positive RET is present in more than 50% of limbs with GSV varicose veins.

The same result can be obtained by a bandage used

to compress the varicose tract or alternatively by sclerotherapy of the varicosities (Fegan’s technique).⁶¹ In other words, the ultrasound detected saphenous reflux is reduced after varicosity avulsion even though saphenous valvular incompetence persists. The saphenous hydrostatic pressure above a ligature does not change after hook phlebectomy, and because valves may narrow due to saphenous caliber reduction, valvular incompetence and recirculating retrograde volume can be reduced or eliminated. This should cause progressive saphenous caliber reduction with a beneficial impact on hemodynamics (see below).

Transmural pressure is the main factor that determines vein diameter² while local-regional saccular dilation has been attributed to reflux and turbulent flow related to high volume blood flow.⁶¹ According to Reynolds’ law, blood which is a viscous fluid changes from laminar to turbulent flow when exceeding a critical velocity. This happens when the volume flow overcomes the capacity of the vessel diameter. Turbulence disperses part of the blood kinetic energy against the vessel wall, veins dilate with time and become tortuous.²

Although saphenous reflux may disappear after hook phlebectomy as shown by ultrasound, it may reappear after some months or years.^{1, 2, 60} This happens when one or more re-entry points that are connected to the deep venous system become re-established. A neoshunt becomes active again and this can eventually result in clinical recurrence when saphenous reflux spills out from the stem towards tributaries, both at the ligature level or in another limb area. After a possible low volume reflux (Figure 8.10 left) in the early post-operative period, recurrence will be characterized by a higher volume reflux (Figure 8.10 right)

A GSV reflux abolition following hook phlebectomy or after first step of CHIVA 2 (analogous to hook phlebectomy) has been reported^{1, 37} (see above) as has reduction in the GSV diameter after ablation of refluxing tributaries.^{24, 37, 45} This reversibility of GSV reflux was reported a long time ago also by Fegan, following compression sclerotherapy.⁴⁶

In a study by Escribano *et al.*¹⁶ of 58 patients treated by the first step of CHIVA 2, GSV diameter was reduced from 6.6 mm before operation to 3.9 mm at 36 months after surgery. However, GSV reflux tended to recur in 53 (91%) of these limbs after the initial transient disappearance. The average GSV diameter in these 53 pa-

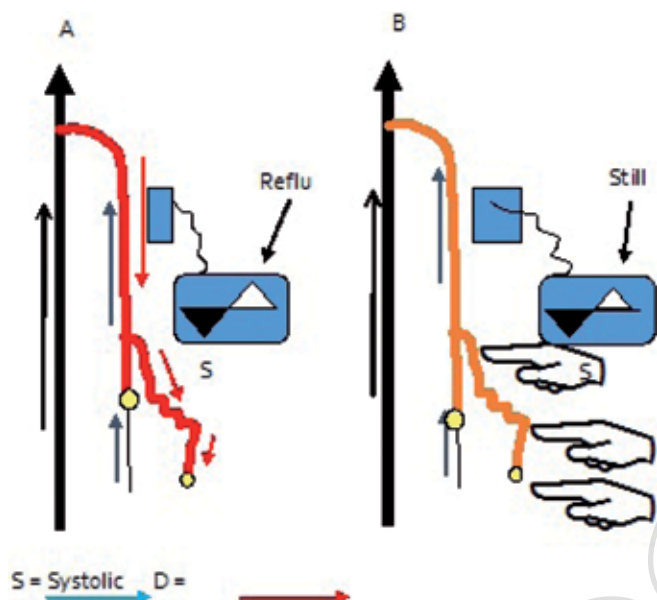

Figure 8.13.—Reflux elimination test.

tients with recurrent reflux was reduced from 7 to 4.3 mm at 36 months follow-up whereas the average diameter in the five patients without recurrent reflux was reduced from 5.8 to 3.7 mm at the same follow-up assessment ($P < 0.003$).

Significant reduction in the common femoral vein diameter was shown at two months after the first step of CHIVA 2 in a study by Mendoza's *et al.*⁶² The GSV diameter changed from 6.1 mm before operation to 4.5 mm after operation in females and 6.8 to 5.1 mm in males while common femoral vein diameter changed from 14.0 mm before operation to 13.7 mm after operation in females and 16.5 to 16.1 mm in males, all these results being statistically highly significant.

Some literature data⁴ have highlighted that many limbs with GSV reflux have SFJ incompetence associated with re-entry points along one or more incompetent tributaries (shunt type III as to Franceschi's classification 58-70%).² However, several other hemodynamic patterns have been highlighted in limbs with GSV-related varices. A competent SFJ terminal valve is very common and is seen in up to 59% of limbs with GSV incompetence.⁶ In these patients, GSV reverse flow may be associated with pelvic vein reflux, an incompetent pre-terminal valve of the SFJ or of other saphenous valves with tributary drainage within the GSV trunk or perforating veins. (Figure 8.11).

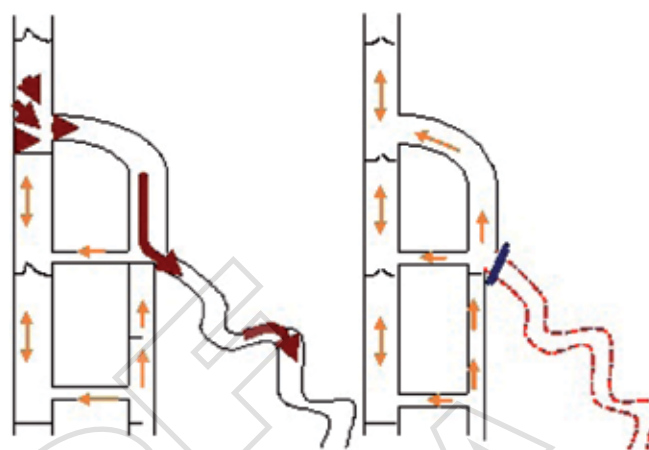



Figure 8.14.—Deep venous reflux in association with incompetent perforating vein and its abolition after proximal ligation of varicosity.

Similarly, re-entry points may be connected to the saphenous stem, with or without further re-entry point(s) along incompetent tributaries (shunt type I or I+III in Franceschi's classification).² In this situation, the RET test is negative as excluding refluxing tributaries does not block GSV reflux which persists though reduced while GSV trunk retrograde flow directly enters into deep veins through perforating veins (Fig. 8.12).²

In Cappelli's series, 55% of limbs with GSV reflux had an incompetent terminal valve while the latter was competent in the remaining 45%.^{50, 51} Terminal valve hemodynamics can significantly interfere with the outcome of any hook phlebectomy procedure. Zamboni demonstrated a clear difference in mid-term follow-up outcomes according to terminal valve competence or incompetence.¹⁸ After the first step of CHIVA 2, the incidence of recurrence determined by ultrasound was significantly higher in patients with terminal valve incompetence (82% vs. 14%). Furthermore, terminal valve competence is associated with a mid-thigh GSV caliber which is mostly below 6 mm,^{50, 51} and this is likely to influence results after hook phlebectomy.

Some literature data report that varicose disease in the lower limbs and more specifically GSV reflux is an ascending disease that starts in the tributaries.²⁷ These contend that the SFJ may be the ending and not the starting point for GSV incompetence in many patients although a multifocal origin by others has been advocated also.^{29, 63}

No specific clinical or ultrasound data have been produced as to possible changes for hemodynamics in the

deep venous system after phlebectomy only. Deep vein reflux may be linked to superficial vein reflux through perforating veins or junctions, which  d conFigure recruitment-based deep vein reflux  (Figure 8.13).

This form of reflux in the deep veins should disappear after ablation of incompetent superficial network, although a completely different outcome would be expected for deep venous reflux due to past DVT. Cavezzi et al.⁶⁴ found that approximately three-quarters of limbs with SSV reflux had associated femoral and/or popliteal reflux and that this deep reflux was usually abolished by SSV surgery. Other authors have shown that reflux disappears in common femoral, femoral, popliteal and gastrocnemius veins after SFJ/GSV treatment.⁶⁵⁻⁶⁹

*The embedded Figures have been modified from Giancesini *et al.*⁵

References

- Franceschi C. Theory and Practice of the Conservative Haemodynamic Cure of Incompetent and Varicose Veins in Ambulatory Patients. Evans J, Translator. Precy-sous-Thil, 1988.
- Franceschi C, Zamboni P. Principles of Venous Hemodynamics. New York: Nova Biomedical Books, 2009.
- Zamboni P, Cisno C, Marchetti F, Mazza P, Fogato L, Carandina S, *et al.* Minimally invasive surgical management of primary venous ulcers vs. compression treatment: a randomized clinical trial. *Eur J Vasc Endovasc Surg* 2003;25(4):313-8.
- Pares JO, Juan J, Tellez R, Mata A, Moreno C, Quer FX, *et al.* Varicose vein surgery: stripping *versus* the CHIVA method: a randomized controlled trial. *Ann Surg* 2010;251(4):624-31.
- Giancesini S, Occhionorelli S, Menegatti E, Zuolo M, Tessari M, Spath P, *et al.* CHIVA strategy in chronic venous disease treatment: instructions for users. *Phlebology* 2014;30(3):157-171.
- Cavezzi A, Labropoulos N, Partsch H, Ricci S, Caggiati A, Myers K, *et al.* Duplex ultrasound investigation of the veins in chronic venous disease of the lower limbs--UIP consensus document. Part II. *Anatomy. Eur J Vasc Endovasc Surg* 2006;31(3):288-99.
- Meissner MH. Lower extremity venous anatomy. *Semin Intervent Radiol* 2005;22(3):147-56.
- Caggiati A. Fascial relationships of the long saphenous vein. *Circulation* 1999;100(25):2547-9.
- Oguzkurt L. Ultrasonographic anatomy of the lower extremity superficial veins. *Diagn Interv Radiol* 2012;18(4):423-30.
- Arnoldi CC. Chapter 82 Physiology and pathophysiology of venous return from the lower leg. *Textbook of angiology*. New York: Springer, 2002. pp. 1002-25.
- Recek C. Venous pressure gradients in the lower extremity and the hemodynamic consequences. *Vasa* 2010;39(4):292-7.
- Lattimer CR, Mendoza E. Superficial Venous Reflux Duration And Cessation Using Two Concurrent Duplex Probes *J Vasc Surg: Venous and Lym Dis* 2015;3(2):154-60.
- Lattimer CR, Azzam M, Kalodiki E, Geroulakos G. Quantifying saphenous recirculation in patients with primary lower extremity venous reflux. *J Vasc Surg: Venous and Lym Dis* 2016;4:in press.
- Zamboni P, Marcellino MG, Cappelli M, Feo CV, Bresadola V, Vasquez G, *et al.* Saphenous vein sparing surgery: principles, techniques and results. *J Cardiovasc Surg (Torino)* 1998;39(2):151-62.
- Zamboni P, Cisno C, Marchetti F, Quaglio D, Mazza P, Liboni A. Reflux elimination without any ablation or disconnection of the saphenous vein. A haemodynamic model for venous surgery. *Eur J Vasc Endovasc Surg* 2001;21(4):361-9.
- Escribano JM, Juan J, Bofill R, Maeso J, Rodriguez-Mori A, Matas M. Durability of reflux-elimination by a minimal invasive CHIVA procedure on patients with varicose veins. A 3-year prospective case study. *Eur J Vasc Endovasc Surg* 2003;25(2):159-63.
- Zamboni P, Escribano JM. Regarding 'Reflux Elimination Without any Ablation or Disconnection of the Saphenous Vein. A Haemodynamic Model for Venous Surgery' and 'Durability of Reflux-elimination by a Minimal Invasive CHIVA Procedure on Patients with Varicose Veins. A 3-year Prospective Case Study'. *Eur J Vasc Endovasc Surg* 2004;28(5):567.
- Zamboni P, Giancesini S, Menegatti E, Tacconi G, Palazzo A, Liboni A. Great saphenous varicose vein surgery without saphenofemoral junction disconnection. *Br J Surg* 2010;97(6):820-5.
- Zamboni P, Marcellino MG, Feo CV, Pisano L, Vasquez G, Bertasi M, *et al.* Alternative saphenous vein sparing surgery for future grafting. *Panminerva Med* 1995;37(4):190-7.
- Nicolaidis AN. Investigation of chronic venous insufficiency: A consensus statement (France, March 5-9, 1997). *Circulation* 2000;102(20):E126-63.
- Franco G. Ambulatory and hemodynamic treatment of varicose veins (CHIVA cure). Revolution or regression. *J Mal Vasc* 1992;17(4):301-7.
- Sarin S, Scurr JH, Coleridge Smith PD. Stripping of the long saphenous vein in the treatment of primary varicose veins. *Br J Surg* 1994;81(10):1455-8.
- Tacconi G, Menegatti E, Fortini P, Legnaro A, Giancesini S, Zamboni P. Impedance and duplex hemodynamic parameters modification induced by hemodynamic correction type 1 (CHIVA 1). *EVF Annual Meeting, Barcelona, Abstract book, 2008.*
- Pittaluga P, Chastanet S, Locret T, Barbe R. The effect of isolated phlebectomy on reflux and diameter of the great saphenous vein: a prospective study. *Eur J Vasc Endovasc Surg* 2010;40(1):122-8.
- Engelhorn CA, Engelhorn AL, Cassou MF, Salles-Cunha SX. Patterns of saphenous reflux in women with primary varicose veins. *J Vasc Surg* 2005;41(4):645-51.
- Caggiati A, Rosi C, Heyn R, Franceschini M, Acconcia MC. Age-related variations of varicose veins anatomy. *J Vasc Surg* 2006;44(6):1291-5.
- Bernardini E, De Rango P, Piccioli R, Bisacci C, Pagliuca V, Genovese G, *et al.* Development of primary superficial venous insufficiency: the ascending theory. Observational and hemodynamic data from a 9-year experience. *Ann Vasc Surg* 2010;24(6):709-20.
- Chastanet S, Pittaluga P. Patterns of reflux in the great saphenous vein system. *Phlebology* 2013;28(Suppl 1):S39-46.
- Labropoulos N, Leon L, Kwon S, Tassiopoulos A, Gonzalez-Fajardo JA, Kang SS, *et al.* Study of the venous reflux progression. *J Vasc Surg* 2005;41(2):291-5.
- Lengyel I, Acsady G. Histomorphological and pathobiochemical changes of varicose veins. A possible explanation of the development of varicosis. *Acta Morphol Hung* 1990;38(3-4):259-67.
- Porto LC, da Silveira PR, de Carvalho JJ, Panico MD. Connective tissue accumulation in the muscle layer in normal and varicose saphenous veins. *Angiology* 1995;46(3):243-9.
- Gandhi RH, Irizarry E, Nackman GB, Halpern VJ, Mulcare RJ, Tilton MD. Analysis of the connective tissue matrix and proteolytic activity of primary varicose veins. *J Vasc Surg* 1993;18(5):814-20.
- Cooper DG, Hillman-Cooper CS, Barker SG, Hollingsworth SJ. Primary varicose veins: the sapheno-femoral junction, distribution of varicosities and patterns of incompetence. *Eur J Vasc Endovasc Surg* 2003;25(1):53-9.
- Abu-Own A, Scurr JH, Coleridge Smith PD. Saphenous vein reflux without incompetence at the saphenofemoral junction. *Br J Surg* 1994;81(10):1452-4.
- Pichot O, Sessa C, Bosson JL. Duplex imaging analysis of the long saphenous vein reflux: basis for strategy of endovenous obliteration treatment. *Int Angiol* 2002;21(4):333-6.

36. Labropoulos N, Giannoukas AD, Delis K, Mansour MA, Kang SS, Nicolaides AN, *et al.* Where does venous reflux start? *J Vasc Surg* 1997;26(5):736-42.
37. Pittaluga P, Chastanet S, Rea B, Barbe R. Midterm results of the surgical treatment of varices by phlebectomy with conservation of a refluxing saphenous vein. *J Vasc Surg* 2009;50(1):107-18.
38. Labropoulos N, Kokkosis AA, Spentzouris G, Gasparis AP, Tassiopoulos AK. The distribution and significance of varicosities in the saphenous trunks. *J Vasc Surg* 2010;51(1):96-103.
39. Muller R. Treatment of varicose veins by ambulatory phlebectomy. *Phlebologie* 1966;19(4):277-9.
40. Ricci S, Caggiati A. Echo-anatomical patterns of the long saphenous vein in patients with primary varices and in healthy subjects *Phlebologie* 1999;14(2):54-8.
41. Ricci S, Cavezzi A. Echo-anatomy of long saphenous vein in the knee region: proposal for a classification in five anatomical patterns. *Phlebologie* 2002;16(3):111-6.
42. Cavezzi A. Diagnostic de l'insuffisance veineuse superficielle des membres inférieurs par echo-doppler-couleur. *Phlébologie* 2000;1:15-22.
43. Cavezzi A, Carigi V, Collura M. Colour flow Duplex scanning as a preoperative guide for mapping and for local anaesthesia in varicose vein surgery. *Phlebologie* 2000;15(1):24-9.
44. Caggiati A. Fascial relationships of the short saphenous vein. *J Vasc Surg* 2001;34(2):241-6.
45. Creton D. Diameter reduction of the proximal long saphenous vein after ablation of a distal incompetent tributary. *Dermatol Surg* 1999;25(5):394-7.
46. Quill RD, Fegan WG. Reversibility of femorosaphenous reflux. *Br J Surg* 1971;58(5):389-93.
47. Pittaluga P, Chastanet S. Predictive value of a pre-operative test for the reversibility of the reflux after phlebectomy with preservation of the great saphenous vein. *J Vasc Surg: Venous and Lym Dis* 2014;2(1):105.
48. Biemans A, Van den Bos R, Hollestein L, *al. e.* The effect of single phlebectomies of a large varicose tributary on great saphenous vein reflux. *J Vasc Surg: Venous and Lym Dis* 2014;2(2):179-87.
49. Pittaluga P, Chastanet S. Persistent incompetent truncal veins should not be treated immediately. *Phlebologie* 2015;30(1 (Suppl)):S98-106.
50. Cappelli M, Molino Lova R, Ermini S, Zamboni P. Hemodynamics of the sapheno-femoral junction. Patterns of reflux and their clinical implications. *Int Angiol* 2004;23(1):25-8.
51. Cappelli M, Molino Lova R, Ermini S, Giangrandi I, Giannelli F, Zamboni P. Hemodynamics of the sapheno-femoral complex: an operational diagnosis of proximal femoral valve function. *Int Angiol* 2006;25(4):356-60.
52. Chastanet S, Pittaluga P. Influence of the competence of the sapheno-femoral junction on the mode of treatment of varicose veins by surgery. *Phlebologie* 2014;29(1 (Suppl)):S61-65.
53. Lemasle P, Uhl JF, Lefebvre-Vilardebo M, Baud JM, Gillot C, Vin F. Veines lympho-ganglionnaires inguinales. Aspects anatomiques et échographiques. Conséquences sur la définition de lanéogenèse. Conséquences thérapeutiques. *Phlébologie* 1999;52(3):263-70.
54. Somjen GM, Donlan J, Hurse J, Bartholomew J, Johnston AH, Royle JP. Venous reflux at the sapheno-femoral junction. *Phlebologie* 1995;10(4):132-5.
55. Jiang P, van Rij AM, Christie R, Hill G, Solomon C, Thomson I. Recurrent varicose veins: patterns of reflux and clinical severity. *Cardiovasc Surg* 1999;7(3):332-9.
56. Pieri A, Vannuzzi A, Duranti A, Vin F, Caillard P, Benelli L, *et al.* Rôle central de la valvule pré-ostiale de la veine saphène interne dans la genèse des varices tronculaires des membres inférieurs *Phlébologie* 1995;48(2):227-9 plus ERRATA *Phlébologie* 1995;48(4):V, VI.
57. Ricci S, Georgiev M. Ultrasound Anatomy of the Superficial Veins of the Lower Limb. *J Vasc Technol* 2002;26(3):183-99.
58. Georgiev M. The femoropopliteal vein. Ultrasound anatomy, diagnosis, and office surgery. *Dermatol Surg* 1996;22(1):57-62.
59. Ricci S. Phlébectomie des varices du pied. *Phlébologie* 2000;53:223-8.
60. Blomgren L, Johansson G, Emanuelsson L, Dahlberg-Akerman A, Thermaenius P, Bergqvist D. Late follow-up of a randomized trial of routine duplex imaging before varicose vein surgery. *Br J Surg* 2011;98(8):1112-6.
61. Fegan WG. Varicose veins: Compression sclerotherapy. Hereford, UK: Berrington Press, 1990.
62. Mendoza E, Berger V, Zollmann C, Bomhoff M, Amsler F. Kaliberreduktion der V. saphena magna und der V. femoralis communis nach CHIVA. *Phlebologie* 2011;40:73-8.
63. Engelhorn CA, Manetti R, Baviera MM, Bombonato GM, Lonardoni M, Cassou MF, *et al.* Progression of reflux patterns in saphenous veins of women with chronic venous valvular insufficiency. *Phlebologie* 2011;27(1):25-32.
64. Cavezzi A, Tarabini C, Collura M, Sigismondi G, Barboni MG, Carigi V. Hemodynamique de la jonction sapheno-poplitee: Evaluation par echo-doppler couleur. *Phlebologie* 2002;55:309-16.
65. Adam DJ, Bello M, Hartshorne T, London NJ. Role of superficial venous surgery in patients with combined superficial and segmental deep venous reflux. *Eur J Vasc Endovasc Surg* 2003;25(5):469-72.
66. Walsh JC, Bergan JJ, Beeman S, Comer TP. Femoral venous reflux abolished by greater saphenous vein stripping. *Ann Vasc Surg* 1994;8(6):566-70.
67. Ali SM, Callam MJ. Results and significance of colour duplex assessment of the deep venous system in recurrent varicose veins. *Eur J Vasc Endovasc Surg* 2007;34(1):97-101.
68. Dix FP, Pictou A, McCollum CN. Effect of superficial venous surgery on venous function in chronic venous insufficiency. *Ann Vasc Surg* 2005;19(5):678-85.
69. Sales CM, Bilof ML, Petrillo KA, Luka NL. Correction of lower extremity deep venous incompetence by ablation of superficial venous reflux. *Ann Vasc Surg* 1996;10(2):186-9.

Chapter 9

Hemodynamic Effects of Relieving Pelvic Venous Reflux and Obstruction

Hemodynamic Effects of Surgical Treatment for Pelvic Congestion Syndrome

Pathophysiology

Pelvic congestion syndrome (PCS) is a clinical combination of symptoms such as pelvic pain, heaviness, dyspareunia, constipation and urinary frequency with signs of vulvar, buttock, perineal and lower limb varices. This is a chronic problem, and symptoms should have been present for at least six months before considering PCS as a possible diagnosis.

PCS can be associated with vein reflux in ovarian and internal iliac vein tributaries or with compression of iliac and left renal veins which in turn is responsible for reflux in ovarian and pelvic veins. These pathophysiological anomalies are responsible for PCS signs and symptoms and/or reflux in lower limb varices. The first step is to eliminate gynecological disease which is the most likely source of pelvic symptoms. When gynecological disease has been eliminated, a dedicated proto-

col is recommended to identify possible candidates for operative treatment.

Investigation

Many protocols are used to identify the presence of PCS and no comparative trial has been published to evaluate the currently used protocols. Nevertheless, there is consensus that selective venography is the best investigation to identify the anatomical and pathophysiological anomalies of PCS. Since selective venography is an invasive investigation, it is recommended that investigations start with non-invasive duplex ultrasonography that will demonstrate findings suggestive of PCS. In daily practice, an investigation diagram is used when female patients consult us for signs and symptoms described above (Figure 9.1).

Transvaginal duplex ultrasound (TVDUS)

This investigation provides both anatomical and hemodynamic information.¹⁻⁸

Anatomical information: absence or presence of venous lakes. If more than 5 lakes are identified with a diameter more than 7 mm we consider that pelvic varices are present.

Hemodynamic information. When pelvic varices are seen which show continuous flow on Doppler imaging, weakly modified by a Valsalva maneuver, left renal vein (LRV) or iliac vein compression is strongly suspected (Figure 9.2). Conversely, when pelvic varices are seen without continuous flow then this suggests isolated reflux, and oscillatory reflux is identified with the Valsalva maneuver (Figure 9.3).

Abdominal transparietal duplex ultrasound (ATDUS)^{6,7}

ATDUS is the first routine investigation when TVDUS cannot be undertaken whatever the reason. ATDUS can identify anatomical lesions such as left renal vein compression or more frequently iliac vein compression (Figures 9.4 and 9.5). Besides, ATDUS provides hemodynamic data on flow in the left renal vein (LRV) and iliac vein as well as reflux in ovarian veins. In obese patients, a CT scan and/or MRI are used as a preliminary investigation providing more information on compression than on reflux.

Venography

*Selective dynamic phlebography (SDP)*⁹ SDP is undertaken when previous investigations suggest pelvic varices, ovarian vein reflux or LRV or iliac vein compression. In a routine protocol, left renal and left common iliac veins, ovarian veins and internal iliac vein tributaries are successively assessed. Three-dimensional imaging including virtual reconstruction has enhanced information quality. SDP provides anatomical information and qualitative hemodynamic information for left renal vein compression and possible associated ovarian reflux (Figures 9.6-9.8) and iliac vein compression with reflux in internal iliac vein tributaries. (Figure 9.9)

Contrast-enhanced, dynamic magnetic resonance venography allows for detailed imaging of the pelvis as well as dynamic vascular imaging.¹⁰

Procedures used for treating PCS

Medical treatment as well as sclerotherapy, open surgery and laparoscopic surgery have been used for treating PCS, but their hemodynamic outcome has not been documented. There is a consensus for agreeing that embolization of pelvic and ovarian veins is the first interventional option for getting long-term good clinical results.¹¹⁻¹⁷

*Clinical outcome data after PCS interventional treatment are available*¹¹

Embolization is fully documented but only one article provides long term information.¹⁴

Hemodynamic outcome data after PCS interventional treatment

Hemodynamic outcome is not documented except in two articles. In one study, diameter reduction of pelvic varices investigated by ultrasound is mentioned with a good correlation with clinical outcome.¹⁶ In the other study, one ultrasound examination of the previously embolized ovarian vein was performed with poor correlation between vein obliteration and clinical outcome.¹²

Conclusion

Hemodynamic data are poorly documented in PCS. Firstly, only qualitative hemodynamic information is

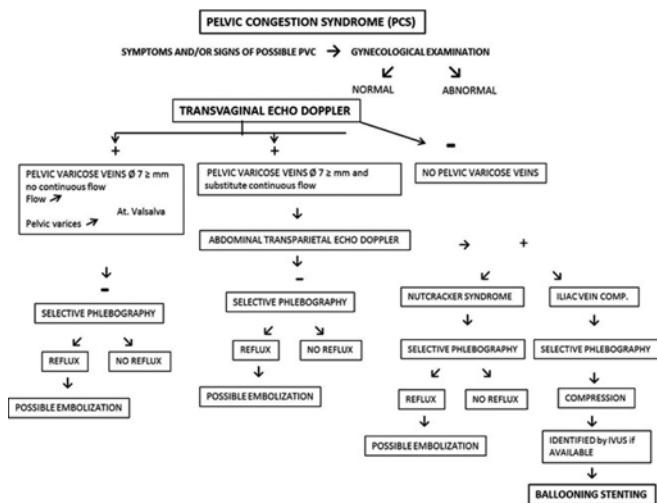

Figure 9.1.—Investigation algorithm.

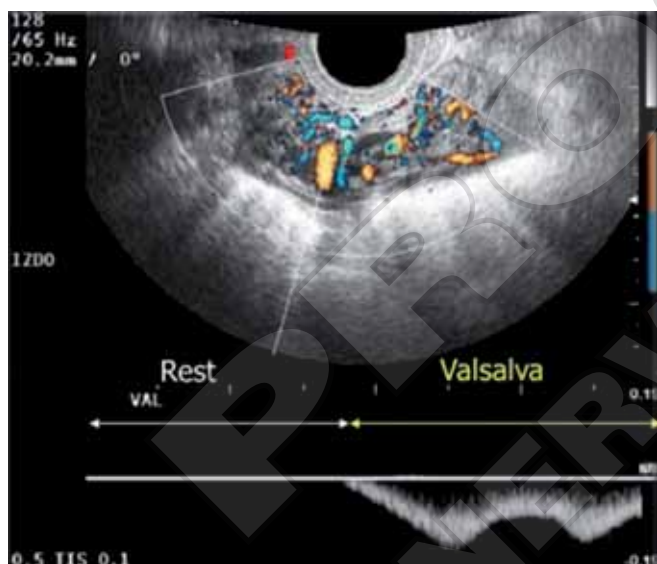

Figure 9.3.—Transvaginal color Doppler ultrasonography in a patient with isolated reflux without LRV or iliac vein compression. Top: Pelvic varices, whose size can be measured. Bottom: There is absence of baseline flow. An oscillatory reflux is identified during a Valsalva maneuver.

available for diagnosing PCS, namely: presence or absence of reflux in gonadal or pelvic veins identified by ultrasound or venography (Figure 9.6, 9.8, 9.12, 9.13), presence or absence of pelvic varices identified by TV-DUS or venography (Figure 9.2, 9.3, 9.12, 9.13). When PCS is caused by left renal or iliac vein compression, hemodynamics are better documented by transparietal ultrasound, (Figure 9.4, 9.5) MRI, CT scan and IVUS



Figure 9.2.—Transvaginal color Doppler ultrasonography in a patient with gonadal or pelvic varices related to left renal vein compression or iliac vein compression. Left: Pelvic varices, whose size can be measured; Right: Continuous high oscillatory flow that increases weakly with Valsalva manoeuver.

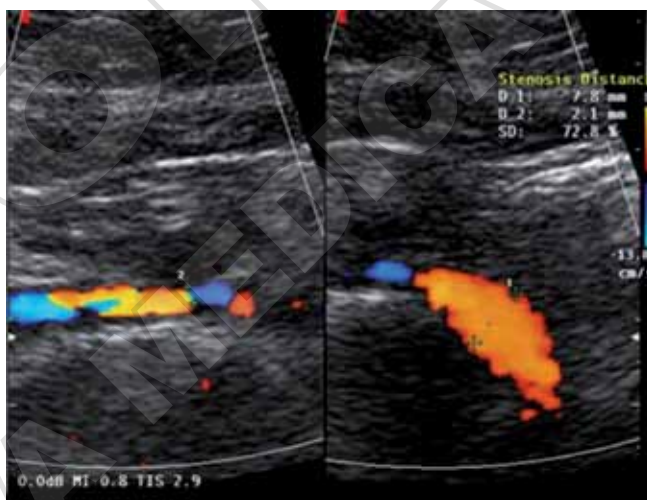

Figure 9.4.—Abdominal transparietal duplex ultrasound. Compression of common left iliac vein (May–Thurner Syndrome) note the decrease of the flow at left primitive iliac vein level.

in terms of stenosis, pressure gradient and flow velocity.

Only qualitative information is available for assessing operative treatment namely: persistence or absence of LRV or iliac vein compression (Figure 9.10, 9.11A and B), gonadal and pelvic refluxing veins, pelvic varices (Figure 9.10, 9.11A and B, Figure 9.13). Validated correlation between clinical severity and investigation outcome is missing.

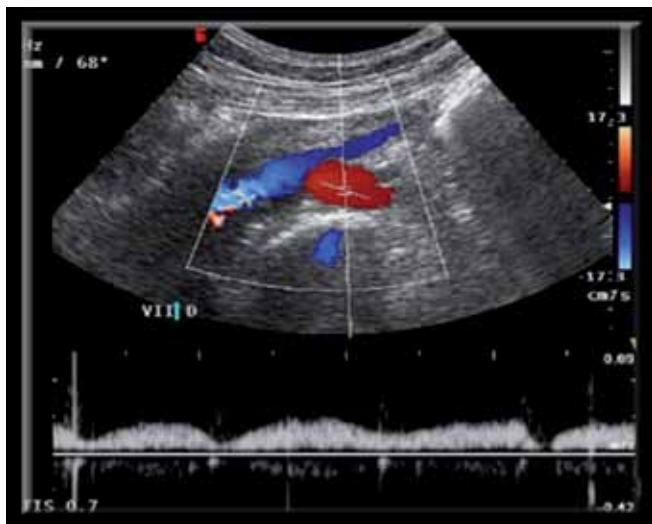

Figure 9.5.—Abdominal transperietal duplex ultrasound (iliac vein compression syndrome). Compression of common right iliac vein with an increase in flow direction right/left internal iliac vein due to collaterals among the left to the right axis.



Figure 9.6.—Venography using brachial access. Left renal vein compression associated with left ovarian vein reflux.

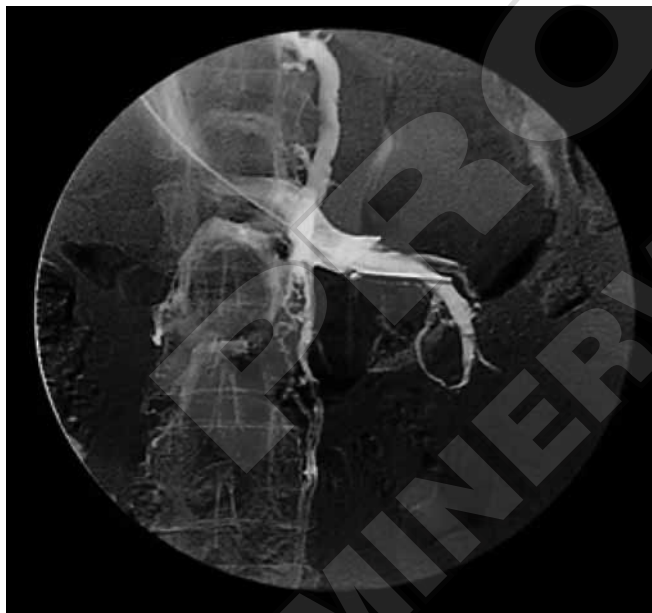

Figure 9.7.—Venography using brachial access. Left renal vein compression without left ovarian vein.



Figure 9.8.—Retroaortic left renal vein compression .Left: venography using femoral access. Both renal vein compression and left ovarian vein reflux are present. Right: computed tomography scan of the same patient.

Hemodynamic effects of relieving iliac vein obstruction

Pathophysiology

Venous outflow obstruction can be caused by inadequate recanalization following deep venous thrombosis,

extravascular compression or congenital abnormalities of the femoral or iliac veins.¹ The most common cause of extravascular compression is compression of the left common iliac vein by the overlying the right common iliac artery, called the May-Thurner syndrome (MTS).²⁻³ Thrombosis which does not completely resolve results in fibrosis of the vessel and can cause damage to valves leading to obstruction and venous reflux. Both obstruction and reflux lead to ambulatory venous hypertension due to the inability to empty the venous reservoir which in turn leads to chronic venous disease.^{1,4} Furthermore, deep vein reflux allows high abdominal pressure to be transmitted into veins of the lower extremity which causes the veins to dilate.^{4, 18} Competent valves in the



Figure 9.9.—Venography using bilateral femoral access: compression of the left common iliac vein and collateral flow through internal iliac vein tributaries.



Figure 9.10.—Same patient as in Figure 9 after stenting. Left common iliac vein compression and collateral flow are no longer identified.

femoral vein may protect the saphenopopliteal junction and the small saphenous vein from this effect.⁴

Moreover, Trendelenburg¹⁹ described a paradoxical circulation in which part of the venous blood returning to the right atrium deviates at the saphenofemoral junction into the incompetent saphenous vein and the varicose veins of the lower limb re-entering deep veins through perforating veins. The calf muscle venous pump needs to deal with the excess of blood volume which causes enlargement of participating veins, reduction in the ejection fraction and increase in residual venous volume leading to ambulatory venous hypertension.⁴

Cockett and Jones described the “blow-out syndrome” in which they attributed ambulatory venous hypertension in the superficial system to blood leaking from the deep system into the superficial system through incompetent perforating veins.²⁰ However, Bjordal *et al.* recorded pressure and flow in incompetent saphenous veins and incompetent calf perforating veins simultaneously showing a predominantly inward flow in patients with primary varicose veins.^{4, 21, 22} During muscle contraction, peak systolic pressure was higher in the posterior tibial vein than the saphenous vein causing

blood to escape outward through the perforating veins, but the opposite happened during muscle relaxation and the inward component appeared to be greater than the outward component.^{4, 23-25}

Collateral veins develop when obstruction occurs. If obstruction is below the junction between the external and internal iliac veins then there are a number of potential changes in lower limb drainage. Blood can flow to the internal iliac vein through the medial circumflex femoral vein to the obturator vein or inferior gluteal vein, through the lateral circumflex femoral vein to the inferior gluteal vein or through the external pudendal vein to the internal pudendal veins or pelvic venous plexuses. When the common iliac vein is also affected, drainage can be enabled by the contralateral external iliac vein via the external pudendal vein or the pubic vein. In cases of bilateral occlusion, the gonadal vein is used as a collateral pathway.²⁶ Furthermore, pelvic venous plexuses are connected with the azygos vein which therefore can also form a collateral circulation.²⁷

Neglén *et al.* performed intraoperative venography in 87 limbs with iliofemoral obstruction, which were going to be treated by angioplasty and stenting. Collaterals were



Figure 9.11.—A) Venography using bilateral femoral vein access: common right iliac vein compression. B) Same patient after stenting. Right common iliac vein compression is no longer identified.



Figure 9.12.—Venography using brachial access and selective ovarian vein catheterization. Valsalva manoeuvre: Unilateral ovarian vein reflux filling pelvic varices through a round ligament vein as well as lower-limb varicose veins.

identified in 72% of all limbs. Transpelvic collaterals were most common (66%) followed by an ascending lumbar vein (16%), paravertebral collaterals (9%) and axial collaterals (9%). Eleven limbs with diffuse iliac vein narrowing did not show collaterals on venography. A relation to preoperative hemodynamic results and intraoperative pressure measurements could not be found.²⁸

Arnoldussen *et al.*²⁹ scored collaterals observed by duplex ultrasound and MRV in 40 consecutive patients with acute DVT or suspected venous disease. A pudend-

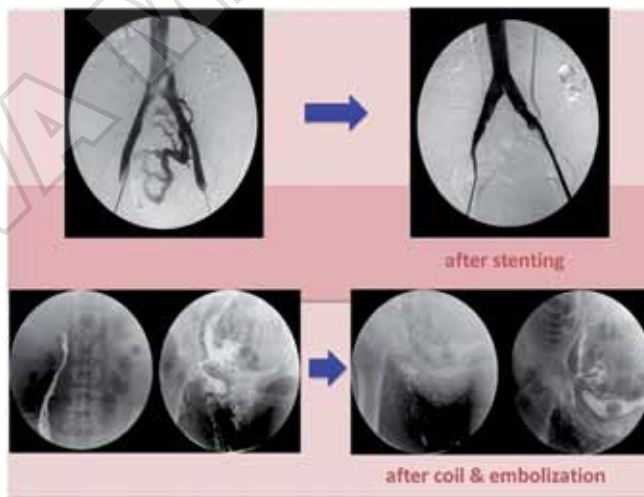

Figure 9.13.—Upper line. Left: Left common iliac vein compression and reflux in internal vein tributary. Right: Both compression and reflux suppressed by stenting. Lower line. Left: Refluxing right ovarian vein feeding pelvic and lower limb varices. Right: after embolization no more reflux and varices.

dal crossover was the most common collateral followed by the inferior epigastric vein and ovarian vein. Atresia of the inferior vena cava was found in two patients both of whom showed azygos collaterals.

Delis *et al.*³⁰ found that 81% of limbs with prior iliofemoral DVT showed venous reflux in both the superficial and deep system during follow-up. The remaining 19% showed reflux only in the superficial system. Air plethysmography (APG) showed that outflow fraction was significantly lower (37% *versus* 49%), venous filling index was significantly higher (VFI, 3.8 mL/s *versus* 1.6 mL/s) and residual volume fraction was also significantly higher (RVF, 45% *versus* 35%) in the post-DVT limbs compared with controls, although the ejection fraction and venous volume were comparable in both groups.

Other tests often performed with venous disease are ambulatory venous pressure (the percentage decrease of baseline pressure from rest to the level at the end of ten tiptoe movements), hand-foot pressure differential (the pressure differential between recordings from needles placed in the dorsal foot vein and a hand vein) and hyperemia-induced pressure increase (rise of dorsal foot vein pressure after reactive hyperaemia induced by ischemia using a cuff). In normal limbs, the hand-foot pressure differential is less than 4 mmHg and the pressure rise in the dorsal vein after hyperaemia is less than 8 mmHg³¹ (see Chapter 3).

In contrast to obstruction, iliac vein reflux is considered hemodynamically irrelevant provided deep veins in the lower limb are competent. Deep or superficial anatomical location of reflux does not determine its hemodynamic severity, whereas quantity of reflux volume does.^{4, 32}

Effect of treatment and long-term follow-up

Oral anticoagulation

Åkesson *et al.*³³ studied 20 patients with acute iliofemoral deep venous thrombosis who were treated with oral anticoagulation alone. Most patients stopped oral anticoagulation after six months and no recurrent thrombosis was observed during follow-up. Maximum venous outflow measured by strain-gauge plethysmography was 31 ml/min/100ml (13-83 mL/min/100ml) at six months, 40 ml/min/100ml (9-122 ml/min/100ml) at three years and 45 ml/min/100ml (12-87 ml/min/100ml) at five years. A maximum venous outflow of less than 33 ml/min/100ml was considered abnormal. This was the case in 80% of patients at six months, 50% of patients at three years and 40% of patients at five years. Improve-

ment was only significant comparing six months to five years. Ambulatory venous pressure was 59 mmHg (10-125 mmHg) at six months and 60 mmHg (21-95 mmHg) at five years. Return time to 90% of resting pressure was also measured and was defined as abnormal when less than 20 seconds. The 90% return time was 18s (0-55s) at six months and 13s (0-71s) at five years and this was statistically significant.³³ The effect of anticoagulation cannot be determined because no measurements were made in the acute phase but this study does show that venous hemodynamics improve after deep venous thrombosis over a period of five years.

Stenting

It is well established on clinical grounds that stenting is a good option for treating iliofemoral venous obstruction. Large single-centre studies have reported primary patency, assisted primary and secondary patency rates of 57–83%, 80–88% and 86–90% in PTS patients and 79–93%, 92–100% and 93–100% in May-Thurner Syndrome patients respectively.^{31, 34} However, little is known about the hemodynamic changes after stenting to recanalize the iliofemoral tract.

Neglén and Raju²⁸ studied 102 limbs in 94 consecutive patients with suspected iliac vein obstruction with the intent to treat any venous occlusion. Ambulatory pressure, hand-foot pressure differential and hyperaemia-induced pressure rise were measured. At baseline, mean ambulatory venous pressure decreased by $50 \pm 17\%$, hand-foot pressure differential by 1.8 ± 1.8 mmHg and hyperaemia-induced pressure rise by 5.8 ± 6.0 mmHg. Seventy-seven limbs were stented with median follow-up of 12 months (1-21 months). Data on preoperative hemodynamics, intraoperative pressure gradients, collateral vessels and degree of stenosis were analysed to identify predictive factors for outcome after stenting. Hand-foot vein pressure differential decreased significantly from 1.4 ± 1.5 mmHg to 0.8 ± 1.3 mmHg but other repeat hemodynamic tests showed no significant improvement after treatment. However, no correlation was found between this data and clinical outcome measured by pain scale or decrease of swelling. Intraoperative venography identified collaterals in 63 of 87 limbs and 62% of these disappeared after angioplasty and/or stenting. Collaterals markedly decreased in 20% of the limbs and no changes were observed in 18%.²⁸

The conclusion was that results of stenting could only be identified hemodynamically by hand-foot vein pressure differential and not by changes in baseline AVP. It may well be that AVP changes are more dependent on reflux changes than reduction in outflow obstruction. Furthermore, no correlation was found between any pressure measurements and development of collateral circuits.

Neglén *et al.*³⁵ extended this study by investigating hemodynamic differences in 139 lower limbs treated by balloon dilation and stenting, 61 with primary disease (MTS) and 78 with post-thrombotic disease (PTS). Ambulatory venous pressure decrease before treatment was 57% (13-99%) in patients with PTS and 61% (31-92%) in patients with primary obstruction which was significantly different. Hand-foot vein pressure differential was 1 mmHg in both groups (range of 0-5 in the PTS group and range of 0-8 mmHg in the primary obstruction group). Hyperaemia-induced pressure elevation was 6 mmHg (range 0-48 mmHg) in the PTS group and 4 mmHg (range 0-16 mmHg) in the primary obstruction group which was significantly different. The wide range of pressure increase during hyperemia indicated that some patients were well compensated by collaterals and others were not. During the procedure, femoral pressure at rest was 12 mmHg (5-25 mmHg) for PTS limbs and 11 mmHg (4-20 mmHg) for the primary obstruction group which was also statistically significant. The increase after intra-arterial injection of papaverine was also significantly higher in the PTS group, 2 mmHg (range 0-22 mmHg) *versus* 1 mmHg (range 0-4 mmHg). The pull-through pressure gradient was not significantly different between the two groups. Pressure measurements were not helpful in determining severity of borderline obstruction. Using intraoperative venography, no differences in collateral formation were observed between the two groups (78% of PTS limbs and 75% of MTS limbs), though in the PTS group 72% of collaterals disappeared after stenting compared with 43% in MTS. Only 11% of limbs did not show any decrease in collaterals in the PTS group as opposed to 27% of limbs in the MTS group.³⁵ This data suggests that the post thrombotic syndrome has a more negative effect on venous hemodynamics than the May-Thurner syndrome though definite differences between hemodynamic changes in stenting for PTS and MTS could not be made, since patients in the PTS group may have had

MTS as an underlying cause of their thrombosis. No investigations concerning correlation between patency and hemodynamic parameters were made.

Rosales *et al.*³⁶ studied 34 patients who underwent endovascular recanalization for iliofemoral obstruction. Pre-operatively only 53% of patients were found to have elevated ambulatory venous pressure with a median of 72 mmHg (64-72 mmHg). Venous pressure gradients and venous occlusion plethysmography measured by APG were abnormal in 50% of all patients. Improvement of venous occlusion plethysmography and venous pressure gradient after stenting was recorded in only four of 18 patients, though no specific values were given. Correlation of hemodynamic values with patency was not tested. Median follow-up was 33 months (1-96 months).³⁶ This indicates that venous pressure gradient and APG measurements for occlusion do not properly reflect the effect of iliofemoral obstruction.

Neglén *et al.*³¹ investigated 982 limbs in 870 consecutive patients with chronic non-malignant iliofemoral obstruction treated by stenting. Hemodynamic measurements were performed before and after treatment in 426 limbs. A significant improvement was shown by ambulatory venous pressure decrease (from $62 \pm 20\%$ to $66 \pm 21\%$), venous filling time (from $32 \pm 35s$ to $36 \pm 32s$), hand-foot pressure differential (from 1.2 ± 1.3 mmHg to 0.8 ± 1.2 mmHg), venous filling index (from 2.5 ± 2.0 ml/s to 2.3 ± 1.0 ml/s) and venous volume (from $87 \pm 40ml$ to $84 \pm 39ml$). Other factors that were tested but did not improve significantly were hyperemia pressure increase (from 5.6 ± 3.9 mmHg to 6.3 ± 4.1 mmHg), ejection fraction (from $57 \pm 22\%$ to $57 \pm 24\%$) and residual volume fraction (from $34 \pm 23\%$ to $32 \pm 25\%$). Again, it may be that many of the APG parameters are more dependent on reflux than outflow obstruction.³¹

A subgroup analysis was performed for limbs undergoing stenting and procedures to correct reflux procedures (n=108) and limbs solely undergoing stenting (n=318). Hand-foot pressure differential did not prove to be significant any more in the limbs also undergoing reflux procedures while the other previously mentioned parameters stayed significant. In the group with stenting alone, only ambulatory venous pressure decrease and hand-foot pressure differential proved significant. Limbs with reflux and stenting alone (n=178) and limbs without reflux and stenting alone (n=105) were also

separated into subgroups. Improvement of hand-foot pressure differential was found to be statistically significant in both groups and improvement of ambulant venous pressure decrease was found to be statistically significant in the group without reflux.³¹ These findings emphasise even further the effect that reflux may have on APG measurements and the importance of measuring both the severity of reflux and outflow resistance in the same limb (see Chapter 10).

Some differences in mean hemodynamic parameters were observed when limbs with non-thrombotic iliac vein obstruction (MTS, n=149) were compared with those with thrombotic obstruction (PTS, n=93). Ambulatory venous pressure decrease only improved significantly after stenting in MTS patients (from $70 \pm 18\%$ to $76 \pm 12\%$) though this parameter was significantly different between groups before treatment ($59 \pm 20\%$ in PTS limbs). Venous volume also only improved significantly in MTS limbs (from $88 \pm 39\text{mL}$ to $81 \pm 42\text{mL}$) with a significant difference before treatment between groups (from $76 \pm 40\text{mL}$ in PTS limbs). Residual volume fraction significantly improved in MTS limbs only (from $34 \pm 22\%$ to $27 \pm 21\%$) without differences before treatment between the two groups.³¹

Mean values before treatment for the parameters that were found to be significant during subgroup analyses were statistically different between the two groups, except for the hand-foot pressure differential between limbs with or without reflux and stenting. Furthermore, 35 limbs in the group solely undergoing stenting were not used in the subanalysis for sole stenting in limbs with or without reflux. The authors did not clarify this discrepancy. Patients who developed recurrence after successful stenting were excluded from hemodynamic analysis altogether so there was no insight in potential hemodynamic difference before or after treatment between patients who successfully underwent stenting and patients who developed recurrence. This study suggests that hemodynamic relief of obstruction does not improve venous insufficiency without treating the reflux. Differences in hemodynamic improvement were found between different etiological groups, though no conclusions can be drawn from these results due to baseline differences between the groups.

Hurst *et al.*³⁷ investigated the results of recanalization in 18 patients diagnosed with May-Thurner syndrome. 17 patients received a stent, whereas one patient under-

went sole angioplasty. Intravascular pressure measurements were performed in 14 of the 18 patients. Mean resting pressure gradient which was 5.6 mmHg before recanalization decreased to 0.6 mmHg after recanalization. The authors did not explain exactly how and when resting pressure gradients were obtained. Only half of the patients underwent APG. Although occlusion or stenosis was present in all cases, none of them had an outflow fraction of less than 40% on APG, the suggested pathological cut-off value.³⁷ This finding suggests that the cut-off point of 40% of venous outflow originally developed for acute DVT may not be applicable in patients with chronic obstruction. APG was not performed post procedure. One patient was lost to follow-up and the other 17 patients were evaluated with a mean follow-up of 17 months (1-43 months). Two stents were occluded upon follow-up. One patient developed symptoms two weeks after primary stent placement due to stent thrombosis and received catheter-directed thrombolysis, angioplasty and an arteriovenous fistula to improve flow. Eight weeks later this patient had a second recurrence and underwent left to right femoral-femoral venous crossover bypass surgery. This patient had a pre-procedure pressure gradient of 14 mmHg that decreased to 1 mmHg after initial recanalization. Another patient was found to have a chronically thrombosed stent after 12 months which could not be recanalized. Because it was thought the patient had an adequate collateral circulation, this patient did not receive a secondary recanalization. No intravenous pressure measurements were available for this patient.³⁷

Delis *et al.*³⁴ studied 23 limbs in 16 patients with PTS who underwent iliofemoral stenting. Venous claudication was present in 10 patients. Healthy limbs of those patients (n=9) were used as a control group. Hemodynamic measurements were performed using strain-gauge plethysmography and pressure measurements in the common femoral vein. Outflow fraction, ejection fraction and residual volume fraction all significantly improved after stenting. Outflow fraction at four seconds improved by 10% (95% CI 6.1% to 13.5%) (P=0.001), ejection fraction by 13.7% (95% CI 6.7% to 22.5%) (P=0.004) and residual venous fraction by 17.7% (95% CI 9.6% to 25.6%) (P=0.002). No changes were observed in the control group. Venous filling index significantly deteriorated after stenting from 16.9 (IQR 11.9 to 29.8) ml/100 ml/sec to 21.0 (IQR 15.7 to 32.4)

ml/100ml/sec ($P=0.004$) with no changes in the control limbs. Venous pressure in supine position significantly decreased after stenting from a median of 8 mmHg (7 – 10.5 mmHg) to a median of 1 mmHg (1 – 2 mmHg). These hemodynamic changes were associated with abolition of claudication in all patients and improvement of CEAP clinical class from median C3 (IQR C3-C5) (CVD distribution C6, 6; C4, 4; C3, 13) before stenting to median C2 (IQR C2-C4.5) (CVD distribution C6, 1; C5, 5; C4, 4; C2, 13) after stenting. This study shows the magnitude of hemodynamic changes associated with improvement in CEAP clinical classes. The 24% mean increase in reflux indicates that the new channel without valves created by stenting may be responsible for additional downward flow of blood.

Patel *et al.*³⁸ treated ten patients with iliofemoral deep venous thrombosis and May-Thurner syndrome by catheter-directed thrombolysis and subsequent recanalization of the common iliac vein. The mean pressure gradient between the inferior vena cava and the external iliac vein was 0.3 ± 0.5 mmHg after stent placement. No measurements were made before treatment.

Bypass

Garg *et al.*³⁹ compared venous bypass surgery to hybrid reconstruction consisting of endophlebectomy, angioplasty and stenting. Surgical reconstruction (29 femorofemoral, 17 femoroiliac-inferior vena cava and six complex bypasses) was performed in 52 cases and hybrid reconstruction was performed in 12 cases. Early graft occlusion occurred less frequently in bypass patients (17% *versus* 33%) and discharge patency was 96% for surgical reconstruction and 92% after hybrid reconstruction. Five-year primary and secondary patency was 42% for bypass and 59% for hybrid reconstruction. Mean follow-up was 41 months. Univariate analysis showed that the type of bypass was significant for primary and secondary patency. At five-year follow-up, these were 70% and 78% for de Palma bypass, 63% and 86% for femoroiliac and ilio-infrahepatic IVC bypass, and 31% and 57% for femoro-infrahepatic IVC bypasses respectively. Multivariate analyses showed that the presence of MTS significantly decreased primary and secondary patency.³⁹ This was not a randomized control trial but a retrospective study of patients treated within a certain time period. Demographics were pre-

sented though not divided by group. Furthermore, 25% of patients were lost to follow-up. This subgroup of patients only had a mean follow-up of eight months (<1-61 months). Sole obstructive pathology was present in 41% of patients and 59% of patients also had associated valvular incompetence with reflux. Surgical bypass seems to be beneficial in early graft patency though not in long-term follow-up. However, no clear statements can be made on hemodynamics due to the design of this study.

Jost *et al.*⁴⁰ retrospectively studied 42 patients who underwent venous reconstruction for iliofemoral or IVC occlusion. Twelve patients had previous surgical intervention of which two had received bypass surgery already. Strain gauge plethysmography was performed in 18 patients and impedance plethysmography in 12. Outflow obstruction was identified in 83% of patients, and 57% of patients also showed associated venous insufficiency on plethysmography. Graft flow was measured using an electromagnetic flow meter. Mean flow was 349 ml/min (20-3000 ml/min) in patients without an arteriovenous fistula (AVF) and 571 ml/min (125-2200 ml/min) in patients with an AVF ($n=22$). Median femorocentral (femorofemoral in patients with unilateral disease) venous pressure gradient was 10 mmHg (1-37 mmHg) in the supine position before treatment. This decreased to 4 mmHg (0-18 mmHg) intraoperatively after reconstruction. Overall three-year primary and secondary patency were 54% and 62% respectively. Mean follow-up was 2.6 years (0.1-11.7 years). Four-year primary and secondary patency for de Palma grafts were 77% and 83% and two-year primary and secondary patency of ilio caval/femorocaval grafts were 38% and 54%. This was not significantly different from de Palma grafts. In three patients, femoro-femoral cross-over PTFE grafts were done which all occluded at one, two and 12 months despite additional AVF.⁴⁰ Although plethysmography was performed in most patients, no clear details were given about the results of these tests. Improvement in impedance plethysmography was only found in two of 12 patients and no improvement of drainage was found using strain-gauge plethysmography. Mean follow-up using plethysmography was 3.1 months (5 days-4.5 years).⁴⁰ Results are difficult to compare because different patency rates were used for each intervention, and no clear statements can be made concerning plethysmography results due to the lack of

information provided. The mean venous pressure gradient decreased although it was not stated whether this difference was significant. Mean flow was higher in patients with AVF but significance was not stated and this was not followed up using patency as outcome.

Conclusion and recommendations

As stated above, little is known about hemodynamic changes after relieving pelvic obstruction and reflux in venous disease. Following stenting, pressure gradients across the obstructed segment seem to decrease as do flow velocity and the hand-foot pressure differential. However, there have been no clear investigations of hemodynamic predictors for outcome from relieving pelvic obstruction. Therefore, its pertinence in detecting success after treatment should be assessed. Correlation between hemodynamic parameters and development of collateral circuits formed after pelvic obstruction has not been found.

Air plethysmography and strain-gauge plethysmography were used in some studies, though abnormal outflow fractions were rarely identified in patients with iliofemoral obstruction. This warrants closer investigation to determine how useful plethysmography is for detecting venous outflow disorders of the lower limb. Solely relieving outflow obstruction does not improve hemodynamic parameters indicative of reflux, and additional procedures are needed to achieve this.

The post thrombotic syndrome seems to affect hemodynamic parameters more than the May-Thurner syndrome. However, most studies do not clearly state whether May-Thurner syndrome could be the underlying cause for the occurrence of the deep venous thrombosis that caused PTS.

Hardly anything is known about the hemodynamic effects of reconstructive surgery to relieve pelvic obstruction. Furthermore, patency rates are considerably worse than for stenting.

However, protocols for testing are not always transparent. In cases of stent occlusion, authors did not elaborate or investigate whether hemodynamic measurements were different in these patients compared to those who did not develop stent occlusion. Furthermore, hemodynamic parameters were tested and pooled in some studies even though treatment was not uniform. Thus, further research with proper protocols in a ho-

mogenous population needs to be performed with quantitative measurements of both reflux and outflow resistance. Patency should be assessed during follow-up and potential differences in hemodynamic results between patients with and without recurrence should be evaluated. Although patency for stenting in venous disorders is well established, hemodynamic parameters are poorly investigated.

References

1. Nicolaides AN. Investigation of chronic venous insufficiency: A consensus statement (France, March 5-9, 1997). *Circulation* 2000;102(20):E126-63.
2. May R, Thurner J. A vascular spur in the vena iliaca communis sinistra as a cause of predominantly left-sided thrombosis of the pelvic veins. *Z Kreislaufforsch* 1956;45(23-24):912-22.
3. May R, Thurner J. The cause of the predominantly sinistral occurrence of thrombosis of the pelvic veins. *Angiology* 1957;8(5):419-27.
4. Recek C. Conception of the venous hemodynamics in the lower extremity. *Angiology* 2006;57(5):556-63.
5. Cypreste Oliveira FA, de Sousa Amorelli CE, Lemos Campedel-li F, Caetano Barreto J, Caetano Barreto M, Moreira da Silva P, *et al*. Treatment of pelvic congestion associated with varicose veins of the lower limbs: report of a small number of cases. *J Vasc Bras* 2012;11(1):62-6.
6. Ignacio EA, Dua R, Sarin S, Harper AS, Yim D, Mathur V, *et al*. Pelvic congestion syndrome: diagnosis and treatment. *Semin Intervent Radiol* 2008;25(4):361-8.
7. Park SJ, Lim JW, Ko YT, Lee DH, Yoon Y, Oh JH, *et al*. Diagnosis of pelvic congestion syndrome using transabdominal and transvaginal sonography. *AJR Am J Roentgenol* 2004;182(3):683-8.
8. Halligan S, Campbell D, Bartram CI, Rogers V, El-Haddad C, Patel S, *et al*. Transvaginal ultrasound examination of women with and without pelvic venous congestion. *Clin Radiol* 2000;55(12):954-8.
9. Craig O, Hobbs JT. Vulval phlebography in the pelvic congestion syndrome. *Clin Radiol* 1975;26(4):517-25.
10. Duran C, Abboud L, Karmonik C, Shah D, Lumsden AB, Bismuth J. The utility of dynamic magnetic resonance venography in the setting of pelvic venous pathology. *J Vasc Surg: Venous and Lym Dis* 2013;1(1):78-81.e1.
11. Monedero JL, Ezpeleta SZ, Perrin M. Pelvic congestion syndrome can be treated operatively with good long-term results. *Phlebology* 2012;27 Suppl 1:65-73.
12. Capasso P, Simons C, Trotteur G, Dondelinger RF, Henroteaux D, Gaspard U. Treatment of symptomatic pelvic varices by ovarian vein embolization. *Cardiovasc Intervent Radiol* 1997;20(2):107-11.
13. Chung MH, Huh CY. Comparison of treatments for pelvic congestion syndrome. *Tohoku J Exp Med* 2003;201(3):131-8.
14. Kim HS, Malhotra AD, Rowe PC, Lee JM, Venbrux AC. Embolotherapy for pelvic congestion syndrome: long-term results. *J Vasc Interv Radiol* 2006;17(2 Pt 1):289-97.
15. Maleux G, Stockx L, Wilms G, Marchal G. Ovarian vein embolization for the treatment of pelvic congestion syndrome: long-term technical and clinical results. *J Vasc Interv Radiol* 2000;11(7):859-64.
16. Pieri S, Agresti P, Morucci M, de' Medici L. Percutaneous treatment of pelvic congestion syndrome. *Radiol Med* 2003;105(1-2):76-82.
17. Venbrux AC, Lambert DL. Embolization of the ovarian veins as a treatment for patients with chronic pelvic pain caused by pelvic venous incompetence (pelvic congestion syndrome). *Curr Opin Obstet Gynecol* 1999;11(4):395-9.
18. Meissner MH, Moneta G, Burnand K, Gloviczki P, Lohr JM, Lurie F, *et al*. The hemodynamics and diagnosis of venous disease. *J Vasc Surg* 2007;46 Suppl S:4S-24S.

19. Trendelenburg F. Ueber die unterbindung der vena saphena magna bei unterschenkelvaricen. Beitr Klinischen Chir. 1891;7(195-210).
20. Cockett FB, Jones DE. The ankle blow-out syndrome; a new approach to the varicose ulcer problem. Lancet 1953;1(6749):17-23.
21. Bjordal R. Simultaneous pressure and flow recordings in varicose veins of the lower extremity. A haemodynamic study of venous dysfunction. Acta Chir Scand 1970;136(4):309-17.
22. Bjordal RI. Circulation patterns in incompetent perforating veins in the calf and in the saphenous system in primary varicose veins. Acta Chir Scand 1972;138(3):251-61.
23. Arnoldi CC. Venous pressure in the leg of healthy human subjects at rest and during muscular exercise in the nearly erect position. Acta Chir Scand 1965;130(6):570-83.
24. Recek C, Koudelka V. Circulatory effect of saphenous reflux in primary varicose veins. Phlebologie 1979;32(4):407-14.
25. Recek C. Venous pressure gradients in the lower extremity and the hemodynamic consequences. Vasa 2010;39(4):292-7.
26. Umeoka S, Koyama T, Togashi K, Kobayashi H, Akuta K. Vascular dilatation in the pelvis: identification with CT and MR imaging. Radiographics 2004;24(1):193-208.
27. Neumann HAM, Langendoen SI. Handboek flebologie: diagnostiek en behandeling van veneuze ziekten: Prelum Uitgevers, 2011.
28. Neglen P, Raju S. Balloon dilation and stenting of chronic iliac vein obstruction: technical aspects and early clinical outcome. J Endovasc Ther 2000;7(2):79-91.
29. Arnoldussen CW, Toonder I, Wittens CH. A novel scoring system for lower-extremity venous pathology analysed using magnetic resonance venography and duplex ultrasound. Phlebology 2012;27 Suppl 1:163-70.
30. Delis KT, Bountouroglou D, Mansfield AO. Venous claudication in iliofemoral thrombosis: long-term effects on venous hemodynamics, clinical status, and quality of life. Ann Surg 2004;239(1):118-26.
31. Neglen P, Hollis KC, Olivier J, Raju S. Stenting of the venous outflow in chronic venous disease: long-term stent-related outcome, clinical, and hemodynamic result. J Vasc Surg 2007;46(5):979-990.
32. Christopoulos DG, Nicolaidis AN, Szendro G, Irvine AT, Bull ML, Eastcott HH. Air-plethysmography and the effect of elastic compression on venous hemodynamics of the leg. J Vasc Surg 1987;5(1):148-59.
33. Akesson H, Brudin L, Dahlstrom JA, Eklof B, Ohlin P, Plate G. Venous function assessed during a 5 year period after acute ilio-femoral venous thrombosis treated with anticoagulation. Eur J Vasc Surg 1990;4(1):43-8.
34. Delis KT, Bjarnason H, Wennberg PW, Rooke TW, Gloviczki P. Successful iliac vein and inferior vena cava stenting ameliorates venous claudication and improves venous outflow, calf muscle pump function, and clinical status in post-thrombotic syndrome. Ann Surg 2007;245(1):130-9.
35. Neglen P, Berry MA, Raju S. Endovascular surgery in the treatment of chronic primary and post-thrombotic iliac vein obstruction. Eur J Vasc Endovasc Surg 2000;20(6):560-71.
36. Rosales A, Sandbaek G, Jorgensen JJ. Stenting for chronic post-thrombotic vena cava and iliofemoral venous occlusions: mid-term patency and clinical outcome. Eur J Vasc Endovasc Surg 2010;40(2):234-40.
37. Hurst DR, Forauer AR, Bloom JR, Greenfield LJ, Wakefield TW, Williams DM. Diagnosis and endovascular treatment of ilio-caval compression syndrome. J Vasc Surg 2001;34(1):106-13.
38. Patel NH, Stookey KR, Ketcham DB, Cragg AH. Endovascular management of acute extensive iliofemoral deep venous thrombosis caused by May-Thurner syndrome. J Vasc Interv Radiol 2000;11(10):1297-302.
39. Garg N, Gloviczki P, Karimi KM, Duncan AA, Bjarnason H, Kalra M, *et al.* Factors affecting outcome of open and hybrid reconstructions for nonmalignant obstruction of iliofemoral veins and inferior vena cava. J Vasc Surg 2011;53(2):383-93.
40. Jost CJ, Gloviczki P, Cherry KJ, Jr., McKusick MA, Harmsen WS, Jenkins GD, *et al.* Surgical reconstruction of iliofemoral veins and the inferior vena cava for nonmalignant occlusive disease. J Vasc Surg 2001;33(2):320-7; discussion 327-8.

Chapter 10

Venous Clinical Severity and Associated Hemodynamic Changes

Classification of Chronic Venous Disease

The **CEAP** (Clinical, Etiological, Anatomical, Pathophysiological) classification was published in the mid 1990s. Several revisions by an ad hoc committee of the American Venous Forum in conjunction with an International ad hoc committee have resulted in an updated version.¹ The aim of the CEAP classification was to facilitate meaningful communication and description of all forms of CVD. Prior to the development of CEAP, hemodynamic measurements were studied in relation to prevalence of symptoms and signs.

Although the CEAP classification provided a precise and reproducible description for different stages of CVD, it lacked quantitative qualities demanded for epidemiological studies and assessment of efficacy of different therapies. For example, venous claudication is an important symptom in chronic deep venous insufficiency (CDVI) but, it is poorly defined as being present or absent and with no indication of severity. Similarly, the pathophysiologic classification (P) adequately defines Pr, Po, and Pr,o for reflux and obstruction in different anatomic locations but we also need a measure of their severity. As a result, a number of disease severity scoring systems have been developed.

Disease severity scoring systems

The **Venous Severity Scoring (VSS)** system has three components, Venous Disability Score (VDS), Venous Segmental Disease Score (VSDS) and Venous Clinical Severity Score (VCSS), and was developed in 2000 by an American Venous Forum ad hoc committee on venous outcomes assessment. The aim was to supplement the CEAP classification by providing an instrument to assess patients' condition during follow-up.² In contrast to CEAP, the VSS includes symptoms as well as signs. It has a good intraobserver and interobserver agreement and validation.^{3, 4} Its applicability to all CEAP clinical classes and its ability to demonstrate subtle changes⁵ make it an ideal tool to evaluate clinical outcome in randomized control trials (RCT).

The **Venous disability score (VDS)** has a maximum of 3, defined as: 0 = asymptomatic, 1 = symptomatic

but able to carry out usual activities without compressive therapy, 2 = can carry out usual activities only with compression and/or limb elevation, 3 = unable to carry out usual activities even with compression and/or limb elevation. Usual activities are defined as patient activities *before* onset of disability from venous disease.

The **Venous Segmental Disease Score (VSDS)** combines the anatomic and pathophysiologic components of CEAP. VSDS is based on venous segmental involvement with major venous segments being graded according to presence of reflux and/or obstruction. This scoring scheme is entirely based on venous imaging, primarily duplex ultrasound but also venographic findings, and weights 11 venous segments for their relative importance when involved with reflux and/or obstruction. There is one VSDS score for reflux (maximum score of 10) and another for obstruction (also a maximum score of 10).

The **Venous Clinical Severity Score (VCSS)** is based on nine clinical characteristics (pain, varicose veins, venous edema, skin pigmentation, inflammation, induration, and number, duration and size of active ulcers) each graded from 0 to 3, and additionally use of conservative therapy (compression and elevation), using the same criteria to produce a 30 point-maximum flat scale.^{3, 6}

Validation of the VSS scoring systems has been reported.^{4, 7-9} to show that the venous severity scores are significantly higher in advanced venous disease and correlate with anatomic extent. VCSS has been found to be equally sensitive and significantly better for measuring changes in response to superficial venous surgery than the CEAP clinical class, while VDS demonstrated comparable and even better performance.⁴ It has been suggested that VCSS may have a more global application in determining the overall severity of venous disease.⁷

A clear association between VCSS and ultrasound findings has been demonstrated suggesting that this score can be used as a screening tool. In a series of 420 limbs with VCSS ranging from 0-8 (0 score in 283 limbs) when the score was dichotomized (0 = normal, 1 = any abnormality), VCSS was a strong predictor of ultrasound scan abnormalities; limbs with VCSS greater than 0 had a 26-fold greater chance of ultrasound scan abnormalities than did limbs with VCSS = 0 (OR, 26.5; 95% CI, 11-64). Sensitivity of VCSS compared with scans was 89.3%, specificity was 76.1%, negative pre-

dictive value for VCSS = 0 was 97.9%, and positive predictive value for any positive score was 36.5%.⁷

VCSS was revised in 2010 to clarify its pain, inflammation and induration components.⁶ For example, pain attributes were expanded to include other less severe symptoms and discomfort such as aching, heaviness, fatigue, soreness and burning if considered to be of venous origin.

Scoring systems to assess the post-thrombotic syndrome (PTS)

Three further different scoring systems have been proposed that are specific for the assessment of the PTS: the **Brandjes**,¹⁰ **Ginsberg**¹¹ and **Villalta**^{12, 13} scales. All three systems use symptoms and signs which are present or absent in the Brandjes system but graded in the other two. The Ginsberg system identifies the presence or absence of PTS without grading its severity. In contrast, the Villalta scale grades symptoms and signs and classifies patients into different PTS severity groups. Because of its reliability, high correlation with relevant health outcomes, acceptability, responsiveness to changes in the severity of PTS and successful use in clinical trials¹⁴ the subcommittee on control of anticoagulation of the Scientific and Standardization Committee of the International Society on Thrombosis and Haemostasis recommended that the Villalta scale should be used in clinical studies to diagnose and grade the severity of PTS.¹⁵

The Villalta Scale

This was introduced in 1994 as a means to evaluate the post-thrombotic syndrome.¹² It scores both symptoms (cramps, pruritus, pain, heaviness, paraesthesiae) and signs (pretibial oedema, induration of the skin, hyperpigmentation, new venous ectasiae, redness and pain during calf compression) by rating their severity from 0 (not present or minimal) to 3 (severe) for a maximum of 33 points, while the presence of a venous ulcer of the lower limb is also recorded. A total score of 15 or more on two consecutive visits or the presence of a venous ulcer indicates severe PTS. A total score of 5 to 14 on two consecutive visits indicates mild PTS. In patients with bilateral thrombosis, the higher score is used. The Villalta scale¹² has been uniformly accepted and shown

to be reproducible including a good inter-observer reliability of measures to assess the post-thrombotic syndrome.¹⁶

In a recent study assessing the Villalta, Ginsberg, Brandjes, Widmer, CEAP, and VCSS systems in terms of interobserver reliability, association with ambulatory venous pressures, ability to assess severity of PTS, ability to assess change in condition over time, and association with patient-reported symptom severity found that only the Villalta scale was able to fulfil all the above criteria,¹⁷ findings that endorse its generalized use for PTS.

Hemodynamic components responsible for development of symptoms

The main factor that determines development and severity of symptoms and signs is venous hypertension (see chapter 4). The prevalence of venous ulceration, active or healed, was examined in a study of 251 legs in patients with venous symptoms as a result of superficial and/or deep venous disease using ambulatory venous pressure (AVP) measurements.¹⁸ No ulceration occurred in limbs with AVP < 30 mm Hg and there was a 100% incidence with AVP > 90 mm Hg. A linear increase occurred from 14% in limbs with AVP between 31 and 40 mm Hg to 100% in limbs with AVP greater than 90 mm Hg ($r = 0.79$). The authors concluded that the correlation between ulceration and AVP was irrespective of whether the patient had superficial or deep venous disease.

It should be emphasised that the effects of venous hypertension are modified by three compensatory mechanisms. The first mechanism is the ability of the lymphatic system to “cope” with increased lymph produced. In some patients the lymphatic drainage can increase up to ten times and the leg may look normal despite severe hypertension, while in some only two times when overt skin changes occur for the same severity of venous hypertension (see chapter 6). The second mechanism is the fibrinolytic activity in the blood and tissues that can remove excess extracellular protein and particularly fibrin, which varies from person to person. Skin changes are rare in the presence of AVP < 35, and skin changes and ulceration are frequent in the presence of AVP > 65.¹⁸ Fibrinolytic activity was measured in a series of 37 patients with moderate venous hypertension with AVP in the range of 35-65. Euglobulin lysis time (ELT)

was normal (less than 240 min) in 12 patients of whom only two had lipodermatosclerosis (LDS) only, in contrast to the remaining ten patients with a low fibrinolytic activity (ELT < 240 min) of whom nine had LDS and seven had both LDS and ulceration ($P < 0.001$).¹⁹ The third factor is time which exerts an adverse effect on the microcirculation with progressive deterioration (see chapters 3 and 6). Hemodynamic abnormalities responsible for development of venous hypertension are reflux, obstruction, efficacy of calf muscle pump and how well the collateral circulation develops when obstruction is present. With the presence of compensatory mechanisms of variable efficacy and often with coexisting hemodynamic abnormalities, it is not surprising that if only one of the above parameters is measured, a relatively poor correlation would be found between the latter and severity of the disease (see below).

The authors of many of the papers quoted below have spent a lot of time trying to find out if one hemodynamic measurement or another can discriminate between different clinical severity classes (e.g. C of CEAP). This approach belongs to the pre-duplex ultrasound era when hemodynamic measurements were used as non-invasive diagnostic tests. Currently, duplex ultrasound provides accurate information about the presence and anatomic extent of reflux or obstruction. Hence, there is no need for hemodynamic measurements to be used as diagnostic tests but instead as measurements that tell us how much reflux and/or how much functional obstruction there is, after the ultrasound examination has been made.

Correlation of measurements of reflux with clinical severity

Anatomic extent of reflux

The anatomic extent of reflux in the pre-duplex ultrasound era could be determined with descending phlebography. Pathological reflux through the popliteal vein was shown to be associated with symptoms but the association was not clear cut.²⁰

As indicated in chapter 3, duplex ultrasound scanning is a sensitive method for detecting reflux and its extent in both superficial and deep veins. In the absence of deep venous obstruction, limbs with reflux confined to the proximal (above knee) superficial or deep veins rarely develop skin changes or ulceration.^{21, 22} In contrast,

even in the presence of normal deep veins, symptoms and signs of CVI are more often found when the entire length of the great saphenous vein (GSV) is involved or when reflux is present in both great and small saphenous veins.^{21, 22} The authors concluded that aching, ankle edema and skin changes in limbs with reflux confined to the superficial system are predominantly associated with reflux in below knee veins. Ulceration was found only when the whole GSV was involved or when reflux was extensive in both great saphenous and small saphenous veins. Multisegmental reflux is more prevalent in legs with ulcers than in non-ulcerated limbs (75% vs 22%).²³ A pattern of reflux that involves two or more of the venous systems (superficial and deep, superficial and perforating or superficial, perforating and deep) is found in approximately two thirds of patients with skin changes or ulceration.²²⁻²⁷ Although these studies were performed prior to the introduction of CEAP or other clinical severity scoring systems, the available evidence suggests that there is a strong association between the severity of chronic venous insufficiency (CVI) and the anatomic distribution and extent of venous reflux.

The anatomic extent of reflux was investigated in a study involving 98 limbs (83 patients), with active chronic venous ulcers. Reflux was present in all limbs except one. Isolated reflux in one system (superficial = 3, deep = 4, perforator = 3) was seen in ten legs (10%), while incompetence in all three systems was seen in 51 legs (52%). Superficial reflux with or without involvement of other systems was seen in 84 legs (86%), 72 legs (73%) had deep reflux with or without involvement of other systems, and incompetent perforator veins were identified in 79 limbs (81%). Axial reflux (continuous reverse flow from the groin region to below knee) was found in 77 limbs (79%). Axial distribution of disease was found in the majority of cases and no patient had isolated deep venous incompetence below the knee.²⁸

The significance of popliteal reflux in relation to development of symptoms was investigated in two studies. The first performed in the late 1970s involved 51 patients (55 limbs) who had had deep venous thrombosis (DVT) extending into the femoral or iliofemoral segment three to five years earlier and ten limbs of ten healthy volunteers. AVP was measured by inserting a needle in a vein on the foot and the presence of reflux in the popliteal vein was determined by a directional Doppler ultrasonic blood velocity detector. All patients

had ascending venography. Those limbs with iliofemoral recanalization and competent popliteal valves had an ambulatory venous pressure of 30 ± 10 mmHg. In limbs with iliofemoral recanalization and incompetent popliteal valves, the mean AVP was 61 ± 8 mmHg. In patients with persistent iliofemoral occlusion and competent popliteal valves, the mean AVP was 38 ± 15 mmHg, while those limbs with proximal occlusion and incompetent popliteal valves had the highest AVP of 85 ± 15 mmHg. In limbs with competent popliteal valves, the incidence of ulceration was nil even in the presence of proximal occlusion. In limbs with incompetent popliteal valves, ulceration had developed in three quarters of the limbs at some time. The results of this study indicated that the most important factor in determining a high AVP and ulceration was the condition of the popliteal valves. Ulceration did not occur even in the presence of proximal occlusion if the popliteal valves were competent. The extent of DVT and recanalization or the failure of recanalization was of secondary importance.²⁹

The second study involved 50 patients who had venographic DVT confined to the calf during the years 1990-1994 and were seen again 6-10 years after the acute event. A significant association was found between popliteal reflux and skin changes. Popliteal reflux on duplex ultrasound was present in 20 limbs of which 12 (71%) were classified as C4-C6. Popliteal reflux was absent in 30 limbs of which only 5 (29%) were C4-C6 ($P < 0.05$).³⁰

The correlation between ultrasound findings as to whether reflux or obstruction were present or absent as against VCSS was tested in a recent study involving 5,814 limbs (2,907 patients) and was found to be poor ($r(s) = 0.23$ ($P < 0.0001$)). This was an inappropriate comparison and conclusion because the majority of patients (83%) were in the C0-C2 classes, which means that most had either normal limbs or limbs with telangiectasiae or varicose veins with a distribution highly skewed towards normality, while there was no attempt to separate reflux from obstruction let alone quantify these parameters¹². In this study, the percentages of patients in the different C-classes were: C0 26%, C1 33%, C2 24%, C3 9%, C4 7%, C5 0.5% and C6 0.2% (mean C 1.41 ± 1.22 and mean VCSS 2.83 ± 0.47).

The results from most studies indicate that the more extensive the reflux, the more severe the disease and the higher is the prevalence of skin changes and ulcer-

ation. In patients with deep venous reflux, the presence of a competent popliteal valve appears to protect the leg from skin changes and ulceration even in the presence of proximal obstruction.

Refilling time, velocity at peak reflux and volume flow

Reflux is a major pathophysiological abnormality in CVD and this is probably the most investigated parameter on duplex ultrasound. The cut-off point for the diagnosis of pathological reflux for superficial and deep veins is acknowledged to be 0.5 and 1.0 seconds respectively.^{21, 31}

A study of 244 limbs with reflux demonstrated an increase in peak reflux velocity (PRV), time of average rate of reflux (TAR) and absolute displaced volume (ADV) in C4-C6 compared with C1-C3, but reflux time (RT) was not significantly different between these groups. There was no significant correlation between RT, PRV, TAR and ADV *versus* clinical severity in limbs with GSV reflux only. However, in limbs with axial deep reflux to below the knee, that is with concomitant reflux at the knee level, only the PRV and TAR had a significant but low correlation with clinical severity ($r=0.32$, $P=0.0036$ and $r=0.22$, $P=0.049$, respectively). They concluded that RT cannot quantify severity of reflux and is a purely qualitative measurement.³²

Quantification of venous reflux was attempted by Yamaki *et al* who stratified 1,132 limbs in 914 patients with primary valvular incompetence into C1-C3 and C4-C6. The mean \pm SD reflux time (RT), peak reflux velocity (PRV) and peak reflux flow (PRF) at the saphenofemoral junction in C1-C3 *versus* C4-C6 were 4.05 ± 2.42 *versus* 3.42 ± 1.87 sec ($P=0.532$), 27.4 ± 21.1 *versus* 49.7 ± 35.3 cm/s ($P<0.0001$) and 26.3 ± 35.6 *versus* 64.7 ± 73.4 mL/s ($P<0.0001$) respectively. The corresponding results at the saphenopopliteal junction were 4.55 ± 2.45 *versus* 3.73 ± 1.92 sec ($P=0.213$), 30.5 ± 16.8 *versus* 39.5 ± 24 cm/s ($P=0.0002$) and 16.5 ± 15.2 *versus* 22.2 ± 23 mL/s ($P=0.0029$) respectively. The data demonstrated considerable overlap. Nevertheless, they concluded that although the PRV and PRF improved the discrimination power between early and advanced CVI, RT was unable to achieve this result.³³ A similar study by the same group used the same parameters in 686 limbs that included patients with secondary as well as primary CVI.³⁴ In secondary chronic venous

insufficiency, they showed that the mean \pm SD PRV had significant discrimination power between C1-C3 *versus* C4-C6 at the femoral vein (14.8 ± 10.1 *versus* 32.4 ± 16.1 cm/s, $P=0.017$) and popliteal vein (18.0 ± 11.2 *versus* 28.9 ± 19.0 cm/s, $P=0.0003$). The same was true for the PRF at the common femoral vein (34.5 ± 4.2 *versus* 66.0 ± 19.1 mL/s, $P=0.011$), femoral vein (21.3 ± 34.3 *versus* 43.8 ± 43.2 mL/s, $P=0.027$) and popliteal vein (15.0 ± 14.6 *versus* 20.1 ± 16.9 mL/s, $P=0.016$). Once again, the overlap in both the PRV and PRF was considerable between the two groups and there was also no significant difference in RT.

Flow volume at peak reflux in mL/sec was measured in the great and small saphenous, and deep veins in 46 patients (47 legs) with symptomatic varicose veins. Skin changes were present in 19 legs. A total reflux greater than 10 mL/sec was associated with a high prevalence of skin changes (66%) irrespective of whether this was in the superficial or deep veins, whereas reflux less than 10 mL/sec was not associated with skin changes.³⁵

Air Plethysmography (APG[®]) provides quantitative measurements of reflux using the venous filling index (VFI) in mL/s and the venous filling time to 90 % of the venous volume (VFT90) in seconds. It was shown by Christopoulos *et al.* that the VFI increased with increasing severity from control subjects to patients with varicose veins to those with post-thrombotic sequelae.³⁶ In a series of 134 limbs with CVD and C1-C6, the prevalence of chronic swelling and skin changes were both zero if VFI was < 3.0 ml/sec, 12% and 19% when VFI was 3-5 ml/sec, 46% and 61% when VFI was 5-10 mL/sec and both 76% when VFI was greater than 10 mL/sec.³⁷

VFI was also significantly higher in classes C2-C6 compared with C0-C1 in a study of 294 limbs by Nishibe *et al.* but they were unable to discriminate the clinical severity.³⁸ Similarly, the mean \pm SD [range] of the VFI in a study by van Bemmelen *et al* was higher in limbs with ulcers ($n=16$, 5.4 ± 3.8 ml/s) and dermatitis ($n=6$, 7.7 ± 4.6 ml/s) compared to those with varicose veins ($n=10$, 2.6 ± 1.7 ml/s). The differences were significant between varicose veins *versus* ulceration ($P=0.003$) and *versus* dermatitis ($P=0.034$). However, there was a large amount of overlap between these groups.³⁹ In a study by Welkie *et al.*, the VFI increased ($P<0.0001$) and the VFT90 decreased ($P<0.0001$) from control legs ($n=94$) to legs with varicose veins and mild swelling ($n=109$) to

pigmentation with moderately severe swelling (n=67).⁴⁰ They noted that no additional hemodynamic deterioration occurred between the skin pigmentation stage and venous ulceration.

A recent study using APG on 93 consecutive patients/legs awaiting endovenous treatment confirmed that the VFT90 decreased with increasing clinical disease.⁴¹ The VFT90 decrease correlated with increasing C class (r=0.343, P=0.001) and increasing VCSS (0.197, P=0.05). Interestingly, none of the 25 (26.9%) patients with a VFT90 > 25 seconds were among the 17 (18.3%) patients in categories C4b-C6 or with a VCSS > 9. The authors hypothesised that the VFT90 may represent the time taken for the anti-gravitational mechanisms in the leg to fail and concluded that the VFT90 may have discriminatory usefulness in stratifying patients with early clinical disease.⁴¹

A study on 145 legs by Menéndez-Herrero *et al.* identified a significant relationship between worsening C class and GSV diameter when patients were stratified according to reflux measured with the Valsalva and Parana manoeuvres.⁴² Correlations (Spearman r) on clinical severity against GSV diameter (averaged at 3 places). VFI from the database of 100 patients from a recent randomised controlled trial⁴³ revealed the following: C of CEAP against GSV diameter and VFI were r=0.26 (P=0.009) and r=0.392 (P<0.0005), respectively. VCSS against GSV diameter and VFI were r=0.219 (P=0.029) and r=0.257 (P=0.01), respectively. Aberdeen varicose vein questionnaire (AVVQ) against GSV diameter and VFI were r=0.086 (P=0.394) and r=0.21 (P=0.036), respectively. The lack of a correlation between GSV diameter and QoL was also confirmed in another study.⁴⁴

However, in a recent study in 443 legs there was no correlation between the venous refill time (VFT) using photo-plethysmography (PPG) and the AVVQ -0.042 (P=0.606).⁴⁵ This is not too surprising because APG has been reported as a better method for evaluating clinically significant venous reflux than PPG.³⁴ In the comprehensive longitudinal vein study known as the Bochum study, it was concluded that PPG was not a means for assessing malfunction in the venous system during childhood and adolescence⁴⁶ although a short VFT had some predictive value in the development of ulceration ten years later.

The presence of saphenous pulsatile flow has been

shown by one group to be more helpful than the presence of reflux in discriminating severe disease.⁴⁷ The most likely explanation of this pulsatile flow, often seen in patients with severe CVD when examined in the standing position, is the result of maximum dilatation of the arterioles allowing the *vis a tergo* to manifest itself on the venous side.

In a detailed study of 182 legs, measurement of GSV diameter at the proximal thigh 15 cm distal to the groin (proximal thigh, PT) as compared to measurement at the SFJ demonstrated higher accuracy and both higher sensitivity and specificity for venous disease class (C of CEAP) as well as for prediction of reflux. Of the 182 legs, 60 had no GSV reflux (controls; group I), 51 had above-knee GSV reflux only (group II) and 71 had GSV reflux above and below knee (group III). GSV diameters in group I measured 7.5 mm at the SFJ and 3.7 mm at the PT. In groups II and III, they measured 10.9 mm at the SFJ and 6.3 mm at the PT (p < 0.001 each). Measurement at the PT revealed higher sensitivity and specificity to predict reflux and clinical class: Sensitivity to predict reflux was 0.80, specificity was 0.88 at PT. Sensitivity for clinical Class (C) was 0.78 and specificity was 0.67 at PT (SFJ). Significant correlations were found with clinical disease classes for the whole sample (Pearson's r=0.46-0.54; p < 0.001) and for legs with reflux alone (Pearson's r=0.39-0.42, p < 0.001). Thus, this measurement may develop as the preferred surrogate parameter for specific clinical situations. That study also revealed that GSV diameter and clinical disease class did not differ irrespective of whether reflux was above the knee only or both above and below knee.⁴⁸ This finding is in disagreement with the belief that the length of refluxing segment of the GSV has an influence on disease severity.^{49, 50}

Neglen and Raju studied the morphologic distribution of venous incompetence (erect duplex ultrasound and descending venography), results of AVP measurement, venous refilling time, the Valsalva test and air-plethysmography (venous refilling index, VFI) for correlation with the clinical severity class as defined by the authors in 118 consecutive limbs (class 0, n = 34; class 1, n = 42; class 2, n = 11; class 3, n = 31).⁵¹ There was pure deep incompetence in 29% of limbs with severe venous disease (class 2/3), only 6% had pure superficial disease and the remainder had a combination. A history of previous thrombosis and the presence of pos-

terior tibial vein incompetence were markedly common with ulcer disease (84% and 42%, respectively). The duplex Doppler ultrasound multisegment score correlated strongly with clinical severity classification ($r = 0.97$). The venous refilling time and VFI had the highest sensitivity in identifying severe venous disease (class 2/3), and the AVP had excellent specificity. The authors concluded that for noninvasive determination of reflux, a combination of VFI and duplex ultrasound scanning not only localized reflux but also separated severe from mild clinical vein disease, with high sensitivity and specificity.

Elevation of venous pressure at rest and during exercise

Elevation of venous pressure at rest and during exercise is often present in patients presenting with swelling and venous claudication as a result of severe outflow obstruction.

Outflow obstruction is always suspected when swelling is the predominant symptom. It may be associated with a history of DVT and development of prominent collateral venous channels in the groin above the pubis or the anterior abdominal wall. Severe outflow obstruction is particularly suspected in patients with post-thrombotic limbs and venous claudication.

Simple leg elevation with the patient supine can provide an estimate of the resting venous pressure by observing the height (in cm) of the heel from the heart level at which the prominent veins in the foot collapse. During direct femoral vein pressure measurements in patients with venographic iliofemoral occlusion and poor pelvic collaterals, the average resting pressure in the supine position is 5.5 ± 10.5 mmHg higher than the unobstructed opposite limb. In the presence of good collateral veins, the gradient between the two limbs was 0.6 ± 1.4 mmHg.⁵² The arm-foot pressure differential in the horizontal position at rest and after reactive hyperemia has been explored by Raju.^{53, 54} Four grades of obstruction were identified (Chapter 4). In grade IV, the arm/foot pressure differential was greater than 5 mmHg (often 15-20) and there was no further increase with reactive hyperemia. Most limbs with venous claudication belonged to this group.

During exercise, elevation of the resting pressure in the dorsal vein of the foot by an average of 22 mmHg

has been found in thrombotic deep vein occlusion involving the femoral vein.⁵⁵ Increase in venous pressure at rest and during exercise in patients with venous claudication are associated with increase in intramuscular pressure.⁵⁶

Combined quantitative measurements of reflux and outflow resistance

As indicated above, attempts to correlate individual venous hemodynamic measurements with symptoms and signs of CVD have produced poor or at best moderate results, probably because of lack of methods to quantitate obstruction. The authors of a recent study hypothesised that the combination of quantitative measurements of (a) overall reflux (superficial and deep) and (b) overall outflow resistance i.e. including the collateral circulation would provide a hemodynamic index that should be related to the severity of the disease.⁵⁷ Twenty-five limbs with CVD and one limb from a healthy volunteer (VCSS 0-13) were studied. The clinical CEAP classification was C0 in one limb, C1 in 2 limbs, C2 in 10 limbs, C3 in 3 limbs, C4 in 1 limb, C5 in 6 limbs and C6 in 3 limbs. Air-plethysmography was used to measure reflux (VFI in mL/sec) when the subject changed position from horizontal to standing. Subsequently, with the subjects horizontal and the foot elevated 25 cm, simultaneous recordings of pressure and volume were made on release of a proximal thigh cuff inflated to 70 mmHg. Pressure change was recorded with a needle in the foot and volume change with air-plethysmography. Flow (Q in mL/min) was calculated at intervals of 0.1 seconds from tangents on the volume outflow curve. Outflow resistance (R) was calculated at 0.1 second intervals by dividing pressure by the corresponding flow ($R = P/Q$). R increased markedly at pressures lower than 30 mmHg due to decrease in vein diameter, so resistance at 30 mmHg (R_{30}) was used in this study. In a multivariable linear regression analysis with VCSS as the dependent variable, both VFI and R_{30} were independent predictors ($P < 0.001$). Using the constant (0.333) and regression coefficients, the regression equation provided a hemodynamic Index (HI) or estimated VCSS = $0.333 + (VFI \times 0.44) + (R_{30} \times 158)$. Thus, HI could be calculated for every patient by substituting VFI and R_{30} in the equation. HI or calculated VCSS was linearly related to the observed VCSS ($r=0.83$).

The results indicate that the combination of quantitative measurements of reflux and outflow resistance provide a hemodynamic index which is linearly related to the VCSS. These findings need to be confirmed in a bigger series.

Venous outflow resistance (VOR) is difficult to measure but attempts have been made using the outflow parameter of APG. In a study of 77 legs with proximal DVT, this could be detected using a cut-off point of 28% of the outflow (in 1 second) in 95%.⁵⁸ The above evidence suggests that an elevated VOR is related to clinical severity. Future studies need to combine this measurement with quantitative measurements of reflux.

References

- Eklof B, Rutherford RB, Bergan JJ, Carpentier PH, Gloviczki P, Kistner RL, Meissner MH, Moneta GL, Myers K, Padberg FT, Perrin M, Ruckley CV, Smith PC, Wakefield TW. Revision of the CEAP classification for chronic venous disorders: consensus statement. *J Vasc Surg* 2004; 40(6):1248-1252.
- Rutherford RB, Padberg FT, Jr., Comerota AJ, Kistner RL, Meissner MH, Moneta GL. Venous severity scoring: An adjunct to venous outcome assessment. *J Vasc Surg* 2000; 31(6):1307-1312.
- Vasquez MA, Wang J, Mahathanaruk M, Buczkowski G, Sprehe E, Dosluoglu HH. The utility of the Venous Clinical Severity Score in 682 limbs treated by radiofrequency saphenous vein ablation. *J Vasc Surg* 2007; 45(5):1008-1014; discussion 1015.
- Kakkos SK, Rivera MA, Matsagas MI, Lazarides MK, Robless P, Belcaro G, Geroulakos G. Validation of the new venous severity scoring system in varicose vein surgery. *J Vasc Surg* 2003; 38(2):224-228.
- Vasquez MA, Munschauer CE. Venous Clinical Severity Score and quality-of-life assessment tools: application to vein practice. *Phlebology* 2008; 23(6):259-275.
- Vasquez MA, Rabe E, McLafferty RB, Shortell CK, Marston WA, Gillespie D, Meissner MH, Rutherford RB. Revision of the venous clinical severity score: venous outcomes consensus statement: special communication of the American Venous Forum Ad Hoc Outcomes Working Group. *J Vasc Surg* 2010; 52(5):1387-1396.
- Passman MA, McLafferty RB, Lentz MF, Nagre SB, Iafrazi MD, Bohannon WT, Moore CM, Heller JA, Schneider JR, Lohr JM, Caprini JA. Validation of Venous Clinical Severity Score (VCSS) with other venous severity assessment tools from the American Venous Forum, National Venous Screening Program. *J Vasc Surg* 2011; 54(6 Suppl):2S-9S.
- Ricci MA, Emmerich J, Callas PW, Rosendaal FR, Stanley AC, Naud S, Vossen C, Bovill EG. Evaluating chronic venous disease with a new venous severity scoring system. *J Vasc Surg* 2003; 38(5):909-915.
- Meissner MH, Natiello C, Nicholls SC. Performance characteristics of the venous clinical severity score. *J Vasc Surg* 2002; 36(5):889-895.
- Brandjes DP, Buller HR, Heijboer H, Huisman MV, de Rijk M, Jagt H, ten Cate JW. Randomised trial of effect of compression stockings in patients with symptomatic proximal-vein thrombosis. *Lancet* 1997; 349(9054):759-762.
- Ginsberg JS, Hirsh J, Julian J, Vander LaandeVries M, Magier D, MacKinnon B, Gent M. Prevention and treatment of postphlebotic syndrome: results of a 3-part study. *Arch Intern Med* 2001; 161(17):2105-2109.
- Villalta S, Bagatella P, Piccioli A, Lensing AW, Prins MH, Prandoni P. Assessment of validity and reproducibility of a clinical scale for the post-thrombotic syndrome. *Haemostasis* 1994; 24((Suppl 1)):158s.
- Prandoni P, Lensing AW, Cogo A, Cuppini S, Villalta S, Carta M, Cattelani AM, Polistena P, Bernardi E, Prins MH. The long-term clinical course of acute deep venous thrombosis. *Ann Intern Med* 1996; 125(1):1-7.
- Kahn SR. Measurement properties of the Villalta scale to define and classify the severity of the post-thrombotic syndrome. *J Thromb Haemost* 2009; 7(5):884-888.
- Kahn SR, Partsch H, Vedantham S, Prandoni P, Kearon C. Definition of post-thrombotic syndrome of the leg for use in clinical investigations: a recommendation for standardization. *J Thromb Haemost* 2009; 7(5):879-883.
- Rodger MA, Kahn SR, Le Gal G, Solymoss S, Chagnon I, Anderson DR, Wells PS, Kovacs MJ. Inter-observer reliability of measures to assess the post-thrombotic syndrome. *Thromb Haemost* 2008; 100(1):164-166.
- Soosainathan A, Moore HM, Gohel MS, Davies AH. Scoring systems for the post-thrombotic syndrome. *J Vasc Surg* 2013; 57(1):254-261.
- Nicolaides AN, Hussein MK, Szendro G, Christopoulos D, Vasdekis S, Clarke H. The relation of venous ulceration with ambulatory venous pressure measurements. *J Vasc Surg* 1993; 17(2):414-419.
- Whawell SA, Harbourne T, Vasdekis S, Christopoulos D, Clark H, A.N. N. The significance of fibrinolytic activity in the development of ulceration in patients with chronic venous insufficiency. *Br J Surg* 1989; 76(6):646-647 (abstr).
- Ackroyd JS, Lea Thomas M, Browse NL. Deep vein reflux: an assessment by descending phlebography. *Br J Surg* 1986; 73(1):31-33.
- Labropoulos N, Leon M, Nicolaides AN, Giannoukas AD, Volteas N, Chan P. Superficial venous insufficiency: correlation of anatomic extent of reflux with clinical symptoms and signs. *J Vasc Surg* 1994; 20(6):953-958.
- Labropoulos N, Giannoukas AD, Nicolaides AN, Veller M, Leon M, Volteas N. The role of venous reflux and calf muscle pump function in nonthrombotic chronic venous insufficiency. Correlation with severity of signs and symptoms. *Arch Surg* 1996; 131(4):403-406.
- Weingarten MS, Branas CC, Czeredareczuk M, Schmidt JD, Wolfarth CC, Jr. Distribution and quantification of venous reflux in lower extremity chronic venous stasis disease with duplex scanning. *J Vasc Surg* 1993; 18(5):753-759.
- Labropoulos N, Delis K, Nicolaides AN, Leon M, Ramaswami G. The role of the distribution and anatomic extent of reflux in the development of signs and symptoms in chronic venous insufficiency. *J Vasc Surg* 1996; 23(3):504-510.
- Hanrahan LM, Araki CT, Rodriguez AA, Kechejian GJ, LaMorte WW, Menzoian JO. Distribution of valvular incompetence in patients with venous stasis ulceration. *J Vasc Surg* 1991; 13(6):805-811; discussion 811-802.
- Lees TA, Lambert D. Patterns of venous reflux in limbs with skin changes associated with chronic venous insufficiency. *Br J Surg* 1993; 80(6):725-728.
- Myers KA, Ziegenbein RW, Zeng GH, Matthews PG. Duplex ultrasonography scanning for chronic venous disease: patterns of venous reflux. *J Vasc Surg* 1995; 21(4):605-612.
- Danielsson G, Arfvidsson B, Eklof B, Kistner RL, Masuda EM, Satoc DT. Reflux from thigh to calf, the major pathology in chronic venous ulcer disease: surgery indicated in the majority of patients. *Vasc Endovascular Surg* 2004; 38(3):209-219.
- Shull KC, Nicolaides AN, Fernandes e Fernandes J, Miles C, Horner J, Needham T, Cooke ED, Eastcott FH. Significance of popliteal reflux in relation to ambulatory venous pressure and ulceration. *Arch Surg* 1979; 114(11):1304-1306.
- Saarienen JP, Domonyi K, Zeitlin R, Salenius JP. Postthrombotic syndrome after isolated calf deep venous thrombosis: the role of popliteal reflux. *J Vasc Surg* 2002; 36(5):959-964.
- van Bemmelen PS, Bedford G, Beach K, Strandness DE. Quantitative segmental evaluation of venous valvular reflux with duplex ultrasound scanning. *J Vasc Surg* 1989; 10(4):425-431.
- Neglen P, Egger JF, 3rd, Olivier J, Raju S. Hemodynamic and clinical impact of ultrasound-derived venous reflux parameters. *J Vasc Surg* 2004; 40(2):303-310.

33. Yamaki T, Nozaki M, Fujiwara O, Yoshida E. Comparative evaluation of duplex-derived parameters in patients with chronic venous insufficiency: correlation with clinical manifestations. *J Am Coll Surg* 2002; 195(6):822-830.
34. Yamaki T, Nozaki M, Sakurai H, Takeuchi M, Kono T, Soejima K. Quantification of venous reflux parameters using duplex scanning and air plethysmography. *Phlebology* 2007; 22(1):20-28.
35. Vasdekis SN, Clarke GH, Nicolaides AN. Quantification of venous reflux by means of duplex scanning. *J Vasc Surg* 1989; 10(6):670-677.
36. Christopoulos D, Nicolaides AN, Szendro G. Venous reflux: quantification and correlation with the clinical severity of chronic venous disease. *Br J Surg* 1988; 75(4):352-356.
37. Nicolaides AN. Investigation of chronic venous insufficiency: A consensus statement (France, March 5-9, 1997). *Circulation* 2000; 102(20):E126-163.
38. Nishibe T, Kudo F, Miyazaki K, Kondo Y, Nishibe M, Dardik A. Relationship between air-plethysmographic venous function and clinical severity in primary varicose veins. *Int Angiol* 2006; 25(4):352-355.
39. van Bemmelen PS, Mattos MA, Hodgson KJ, Barkmeier LD, Ramsey DE, Faught WE, Sumner DS. Does air plethysmography correlate with duplex scanning in patients with chronic venous insufficiency? *J Vasc Surg* 1993; 18(5):796-807.
40. Welkie JF, Comerota AJ, Katz ML, Aldridge SC, Kerr RP, White JV. Hemodynamic deterioration in chronic venous disease. *J Vasc Surg* 1992; 16(5):733-740.
41. Lattimer CR, Kalodiki E, Azzam M, Geroulakos G. Reflux time estimation on air-plethysmography may stratify patients with early superficial venous insufficiency. *Phlebology* 2013; 28:101-108.
42. Mdez-Herrero A, Gutierrez J, Cambor L, Carreno J, Llana J, Rguez-Olay J, Suarez E. The relation among the diameter of the great saphenous vein, clinical state and haemodynamic pattern of the saphenofemoral junction in chronic superficial venous insufficiency. *Phlebology* 2007; 22(5):207-213.
43. Lattimer CR, Azzam M, Kalodiki E, Shawish E, Trueman P, Geroulakos G. Cost and effectiveness of laser with phlebectomies compared with foam sclerotherapy in superficial venous insufficiency. Early results of a randomised controlled trial. *Eur J Vasc Endovasc Surg* 2012b; 43(5):594-600.
44. Gibson K, Meissner M, Wright D. Great saphenous vein diameter does not correlate with worsening quality of life scores in patients with great saphenous vein incompetence. *J Vasc Surg* 2012; 56(6):1634-1641.
45. Shepherd AC, Gohel MS, Lim CS, Davies AH. A study to compare disease-specific quality of life with clinical anatomical and hemodynamic assessments in patients with varicose veins. *J Vasc Surg* 2011; 53(2):374-382.
46. Stucker M, Reich S, Robak-Pawelczyk B, Moll C, Rudolph T, Altmeyer PJ, Weindorf NG, Hirche H, Gambichler T, Schultz-Ehrenburg U. Changes in venous refilling time from childhood to adulthood in subjects with apparently normal veins. *J Vasc Surg* 2005; 41(2):296-302.
47. Lattimer CR, Azzam M, Kalodiki E, Makris GC, Geroulakos G. Saphenous pulsation on duplex may be a marker of severe chronic superficial venous insufficiency. *J Vasc Surg* 2012; 56(5):1338-1343.
48. Mendoza E, Blattler W, Amsler F. Great Saphenous Vein Diameter at the Saphenofemoral Junction and Proximal Thigh as Parameters of Venous Disease Class. *Eur J Vasc Endovasc Surg* 2013.
49. Theivacumar NS, Darwood RJ, Dellegrammaticas D, Mavor AI, Gough MJ. The clinical significance of below-knee great saphenous vein reflux following endovenous laser ablation of above-knee great saphenous vein. *Phlebology* 2009; 24(1):17-20.
50. Theivacumar NS, Dellegrammaticas D, Mavor AI, Gough MJ. Endovenous laser ablation: does standard above-knee great saphenous vein ablation provide optimum results in patients with both above- and below-knee reflux? A randomized controlled trial. *J Vasc Surg* 2008; 48(1):173-178.
51. Neglen P, Raju S. A rational approach to detection of significant reflux with duplex Doppler scanning and air plethysmography. *J Vasc Surg* 1993; 17(3):590-595.
52. Negus D, Cockett FB. Femoral vein pressures in post-phlebitic iliac vein obstruction. *Br J Surg* 1967; 54(6):522-525.
53. Raju S. New approaches to the diagnosis and treatment of venous obstruction. *J Vasc Surg* 1986; 4(1):42-54.
54. Raju S, Fredericks R. Venous obstruction: an analysis of one hundred thirty-seven cases with hemodynamic, venographic, and clinical correlations. *J Vasc Surg* 1991; 14(3):305-313.
55. Hjelmsstedt A. Pressure decrease in the dorsal pedal veins on walking in persons with and without thrombosis. A study of a fracture series. *Acta Chir Scand* 1968; 134(7):531-539.
56. Qvarfordt P, Eklof B, Ohlin P, Plate G, Saltin B. Intramuscular pressure, blood flow, and skeletal muscle metabolism in patients with venous claudication. *Surgery* 1984; 95(2):191-195.
57. Nicolaides A, Clark H, Labropoulos N, Geroulakos G, Lugli M, Maleti O. Quantitation of reflux and outflow obstruction in patients with CVD and correlation with clinical severity. *Int Angiol* 2014; 33(3):275-281.
58. Kalodiki E, Calahoras LS, Delis KT, Zouzias CP, Nicolaides AN. Air plethysmography: the answer in detecting past deep venous thrombosis. *J Vasc Surg* 2001; 33(4):715-720.

Venous hemodynamic measurements in the investigation of lower limb venous disease: the UIP Consensus according to scientific evidence

Lists of Authors Name & Affiliation

President of UIP: A. Scuderi

Editors

B.B. Lee, M. Meissner, K. Myers, A. N. Nicolaides

Editorial Committee

Claudio Allegra, Pier Luigi Antignani, Kirk Beach, Eliete Bouskela, Lena Blomgren, Attilio Cavezzi, Alun Davies, Marianne De Maeseener, Claude Franceschi, Antonios Gasparis, George Geroulakos, Peter Gloviczki, Stavros Kakkos, RLM Kurstjens, Nicos Labropoulos, Christopher R Lattimer, Erika Mendoza, Javier Leal Monedero, Greg Moneta, Giovanni Mosti, Hugo Partsch, Fausto Passariello, Michel Perrin, Stefano Ricci, Cees HA Whittens, Paolo Zamboni

Editorial Secretary

E. Kalodiki

Faculty (Name and Affiliation)

— Claudio Allegra, MD, Director of Vascular Diseases Master, S. Giovanni Hospital, Rome, Italy
 — Pier Luigi Antignani, MD, PhD, Professor of angiology, director, vascular centre, clinica nuova villa claudia, Rome, Italy

- Niels Bækgaard, MD, Associate Professor, Vascular Clinic, Gentofte Hospital and Rigshospitalet, University of Copenhagen, Denmark
- Kirk W. Beach, PhD, MD, Emeritus Research Professor, Division of Vascular Surgery and Department of Bioengineering, University of Washington, Seattle, Wash, USA
- Giovanni Belcaro, MD, PhD, Irvine3 Labs, ChPe University, Italy
- Stephen Black, MD, Consultant Vascular Surgeon and Clinical Lead for Venous and Lymphoedema Surgery, Guy's and St Thomas' Hospital, London
- Lena Blomgren, MD, PhD Department of Vascular Surgery Karolinska University Hospital Stockholm, Sweden
- Eliete Bouskela, MD, Professor, Biomedical Center, State University of Rio de Janeiro, Brazil
- Massimo Cappelli, MD, Vascular Surgeon, Florence, Italy
- Joseph A. Caprini, MD, MS, FACS, RVT, Louis W. Biegler Chair of Surgery, Division of Vascular Surgery, North Shore University Health System, Evanston, IL, USA and Clinical Professor of Surgery, The University of Chicago Pritzker School of Medicine, Chicago, IL.
- Patrick Carpentier, MD, HDR, Department of Vascular Medicine, University Hospital, Grenoble, France
- Attilio Cavezzi, MD, Vascular Surgeon, Medical Director of Eurocenter Venalinfa, San Benedetto del Tronto, Italy
- Sylvain Chastanet, MD, *Vascular surgery, RIVIERA VEINE INSTITUT*, Monaco
- Jan T. Christenson, MD, PhD. Division of Cardiovascular Surgery, *Venous Centre*, Department of Surgery, University Hospital of *Geneva* and Faculty of Medicine, University of *Geneva*, *Geneva*, and Venous Centre, Clinique Vert Pré, Geneva, Switzerland
- Demetris Christopoulos, MD, PhD (London), Professor of Vascular Surgery, University of Thessaloniki, Medical School, Head of Vascular Surgery, "G. Gennimatas" General Hospital, Thessaloniki, Greece.
- Heather Clarke, MD, Tutor, Department of Medical Imaging and Radiation Sciences, Monash University, Melbourne, Victoria
- Alun H Davies, MA, DM, DSc, FRCS, FHEA, FEBVS, FACPh, Professor of Vascular Surgery & Honorary Consultant Surgeon, Section of Vascular Surgery, Division of Surgery, Department of Surgery & Cancer, Faculty of Medicine, Imperial College School of Medicine, London, UK
- Marianne G.R. De Maeseneer, MD, Professor, Department of Vascular Surgery, University Hospital of Antwerp, Antwerp, Belgium and Professor, Department of Dermatology, Erasmus Medical Centre, Rotterdam, Netherlands
- Bo Eklöf, MD, PhD, Lund university, Sweden.
- Stefano Ermini, MD, Professor of Hemodynamic Phlebology, University of Camerino, Italy
- Fidel Fernández, MD Angiologist and Vascular Surgeon. Senior Staff and Professor of Surgery. Servicio de Angiología y Cirugía Vascular. Hospital Clínico Universitario San Cecilio. Granada. España
- Claude Franceschi, MD, Co-Director of Angiology qualification. Pitié Salpêtrière University Paris. Angiologist consultant at Hopital Saint Joseph and CHU Pitié salpêtrière, Paris, France
- Antonios P. Gasparis, MD, FACS. Division of Vascular Surgery, Department of Surgery, Stony Brook Medicine, Stony Brook, NY, USA
- George Geroulakos, FRCS, PhD Professor and Chair of Vascular Surgery, University of Athens, Director, Department of Vascular Surgery, Attikon General University Hospital, Athens. Professor of Vascular Surgery, Imperial College, London
- Sergio Giancesini, MD, Vascular Disease Center, University of Ferrara, Ferrara, ITALY
- Athanasios Giannoukas, MSc, MD, PhD, FEBVS, Professor of Vascular Surgery, Department of Vascular Surgery, University Hospital of Larissa, Faculty of Medicine, School of Health Sciences, University of Thessaly, Larissa, Greece
- Peter Gloviczki, MD, FACS, Joe M. and Ruth Roberts Professor of Surgery, Division of Vascular and Endovascular Surgery, Mayo Clinic College of Medicine, Rochester, MN, USA
- Ying Huang, MD, PhD, Division of Vascular and Endovascular Surgery, Mayo Clinic, Rochester, MN, USA
- Veronica Ibegbuna, BSc, PhD. Department of Vascular Surgery, Josef Pflug Vascular Laboratory, Ealing Hospital, Middlesex, UK.
- Stavros Kakkos, MD, Assistant Professor, Department of Vascular Surgery, University of Patras, Greece

- Evi Kalodiki, MD, BA, DIC, PhD, FRCS. Josef Pflug Vascular Laboratory, Ealing Hospital and Imperial College London SW7 2AZ, UK and Thrombosis and Hemostasis Research Laboratory, Loyola University Medical Centre, Maywood, Ill, USA.
- Robert L. Kistner, M.D. Clinical Professor of Surgery, University of Hawaii, Honolulu, Hawaii, USA
- T. (Tilo) Kölbel, MD, PhD. German Aortic Center; University Heart Center Hamburg, Germany
- R.L.M. Kurstjens, MD. Department of vascular surgery and Cardiovascular Research Institute Maastricht, Maastricht University Medical Centre, Maastricht, The Netherlands.
- Nicos Labropoulos, PhD, Professor of Surgery and Radiology, Director, Vascular Laboratory, Department of Surgery, Stony Brook University Medical Center, Stony Brook, NY, USA
- James Laredo, MD, PhD, FACS. Associate Professor of Surgery, Division of Vascular Surgery, Department of Surgery, George Washington University, Washington DC, USA
- Christopher R Lattimer, MBBS, FRCS, MS, PhD. Josef Pflug Vascular Laboratory, Department of Vascular Surgery, Ealing Hospital and Imperial College, London, UK
- B. B. (Byung-Boong) Lee, MD, PhD, FACS. Professor of Surgery, Division of Vascular Surgery, Department of Surgery, George Washington University, Washington DC, USA
- M. (Marzia) Lugli, MD. Vascular Surgery, Department of Cardiovascular Surgery, Hesperia Hospital, Modena, Italy
- Fedor Lurie, MD, PhD, RPVI, RVT. Jobst Vascular Institute, Promedica, Toledo, OH and Adjunct Research Professor, University of Michigan, Ann Arbor, MI, USA
- O. (Oscar) Maleti, MD. Chief of Vascular Surgery, Department of Cardiovascular Surgery, Hesperia Hospital, Modena, Italy
- Jovan N. Markovic, M.D. Department of Surgery, Division of Vascular Surgery, Duke University Medical Center, Durham NC, USA
- Mark H. Meissner, MD, Professor of Surgery, Department of Surgery, University of Washington, Seattle, WA, USA
- Erika Mendoza, MD, PhD, General Secretary of the German Society of Phlebology, Chair of the German Society of CHIVA, Wunstorf, Germany
- Gregory Moneta, M.D. Professor and Chief Vascular Surgery, Department of Surgery, Oregon Health & Science University, Knight Cardiovascular Institute, Portland, OR, USA
- J. (Javier) Leal Monedero, MD. Head of Angiology and Vascular Surgery Unit, Ruber Internacional Hospital, Madrid, Spain.
- Hayley M Moore (H M Moore), BAhons (Cantab), MA, MRCS(Eng). Honorary Research Fellow, Academic Section of Vascular Surgery, Imperial College London, UK and Registrar in Vascular Surgery, London Deanery, UK.
- Nick Morrison, MD, FACS, FACP. Morrison Vein Institute, Scottsdale, Arizona, USA
- Giovanni Mosti, MD. Head, Department of Angiology, Clinica MD Barbantini, Lucca, Italy
- Kenneth Myers, MD, Professor, Victoria Vein Clinic, East Melbourne, Australia
- Olle Nelzén, MD. Dpts of Research & Development and Vascular Surgery, Skaraborg Hospital Skövde, Associate Professor of Vascular Surgery, Uppsala University, Sweden
- Andrew N. Nicolaidis, MS, Emeritus Professor of Vascular Surgery, Imperial College, London University, London, UK and Special Scientist, Biological Sciences, University of Cyprus, Nicosia, Cyprus
- Alfred Obermayer, MD, Institute of Functional Phlebologic Surgery, Karl Landsteiner Society, Melk, Austria
- Tomohiro Ogawa, MD, PhD, Department of Cardiovascular Surgery, Fukushima Daiichi Hospital, Fukushima, Japan
- Kurosh Parsi MBBS, MSc(Med), PhD, FACD, FACP. A/Prof. St.Vincent's Hospital, Sydney, University of New South Wales (UNSW), Australia
- Hugo Partsch, MD, PhD, Emeritus Professor of Dermatology, Medical University of Vienna, Austria
- Fausto Passariello, MD Vascular Surgeon, President at the Vasculab Foundation, Napoli, Italy
- Michel R. Perrin, MD, Professor & Vascular Surgeon, Vascular Department, Lyon Hospital, Lyon, France
- Paul Pittaluga, MD, *Vascular surgery, RIVIERA VEINE INSTITUT*, Monaco
- Seshadri Raju, MD, FACS. Emeritus Professor of and Honorary Surgeon, University of Mississippi Medical Center, Jackson, MS, and The Rane Center, Jackson, MS, USA

- Stefano Ricci, MD Phlebologist, Rome, Italy
 - Antonio Rosales, MD. Vascular Surgeon – Head of Unit (NOVI), Norwegian National Unit for Reconstructive Deep Venous Surgery (NOVI), Department of Vascular Surgery | Oslo University Hospital, Oslo, Norway
 - Angelo Scuderi, MD. Director of Angiology and Vascular Dept. of University Hospital Santa Lucinda (Pontifical Catholic University of Sao Paulo– PUC-SP), Sao Paulo, Brazil
 - Carl-Erik Slagsvold, MD, PhD. Senior Consultant. Dept. of Vascular Investigations, Oslo University Hospital, Oslo, Norway
 - Anders Thurin, MD. Dept of Clinical Physiology, Sahlgrenska University Hospital, Gothenburg, Sweden.
 - Tomasz Urbanek, MD, PhD, Department of General Surgery , Vascular Surgery, Angiology and Phlebology, Medical University of Silesia, Katowice, Poland
 - Andre M van Rij, MD. Ralph Barnett Professor of Surgery Department of Surgical Sciences, Dunedin School of Medicine, University of Otago, Dunedin , New Zealand
 - Michael A Vasquez, MD. The Venous Institute of Buffalo, Clinical Assistant Professor of Surgery, University at Buffalo, SUNY, Buffalo, USA
 - Cees H.A. Wittens, MD, PhD. Professor of Venous Surgery, Head of Venous Surgery, Maastricht University Medical Center, The Netherlands
 - Paolo Zamboni, MD. Vascular Diseases Center, University of Ferrara, Ferrara, Italy
 - Steven E. Zimmet, MD, RPVI, RVT, FACPh, Zimmet Vein & Dermatology
 - S. (Santiago) Zubicoa Ezpeleta, MD. Head of Interventional Vascular Radiology Unit, Ruber International Hospital, Madrid, Spain.
- Total 72 faculty members (01-04-16).